



OWNER'S MANUAL

Operation

Maintenance

Specifications

All information in this Owner's Manual is current at the time of publication. However, HYUNDAI reserves the right to make changes at any time so that our policy of continual product improvement may be carried out.

This manual applies to all models of this vehicle and includes descriptions and explanations of optional as well as standard equipment.

As a result, you may find material in this manual that does not apply to your specific vehicle.

CAUTION: MODIFICATIONS TO YOUR HYUNDAI

Your HYUNDAI should not be modified in any way. Such modifications may adversely affect the performance, safety or durability of your HYUNDAI and may, in addition, violate conditions of the limited warranties covering the vehicle. Certain modifications may also be in violation of regulations established by the Department of Transportation and other government agencies in your country.

TWO-WAY RADIO OR CELLULAR TELEPHONE INSTALLATION

Your vehicle is equipped with electronic components. It is possible for an improperly installed/adjusted two-way radio or cellular telephone to adversely affect electronic systems. For this reason, we recommend that you carefully follow the radio manufacturer's instructions or consult your HYUNDAI dealer for precautionary measures or special instructions if you choose to install one of these devices.

SAFETY AND VEHICLE DAMAGE WARNING

This manual includes information titled as DANGER, WARNING, CAUTION and NOTICE. These titles indicate the following:

DANGER

DANGER indicates a hazardous situation which, if not avoided, will result in death or serious injury.

WARNING

WARNING indicates a hazardous situation which, if not avoided, could result in death or serious injury.

CAUTION

CAUTION indicates a hazardous situation which, if not avoided, could result in minor or moderate injury.

NOTICE

NOTICE indicates a situation which, if not avoided, could result in vehicle damage.

CALIFORNIA PROPOSITION 65

WARNING

Operating, servicing and maintaining a passenger vehicle or off-highway motor vehicle can expose you to chemicals including engine exhaust, carbon monoxide, phthalates, and lead, which are known to the State of California to cause cancer and birth defects or other reproductive harm. To minimize exposure, avoid breathing exhaust, do not idle the engine except as necessary, service your vehicle in a well ventilated area and wear gloves or wash your hands frequently when servicing your vehicle. For more information go to www.P65Warnings.ca.gov/passenger-vehicle.

WARNING

Battery posts, terminals, and related accessories contain lead and lead compounds, chemicals known to the State of California to cause cancer, birth defects and reproductive harm. Batteries also contain other chemicals known to the State of California to cause cancer. Wash hands after handling.

Table of contents

| | |
|---|----|
| Introduction | 1 |
| Picture index | 2 |
| Seats & safety system | 3 |
| Instrument Cluster | 4 |
| Convenience features | 5 |
| Driving your vehicle | 6 |
| Driver assistance system | 7 |
| Emergency situations | 8 |
| Maintenance | 9 |
| Vehicle information, reporting safety defects, and consumer information | 10 |
| Index | I |

1. Introduction

| | |
|----------------------------|-----|
| Introduction | 1-2 |
| HYUNDAI Motor America..... | 1-3 |
| Safety messages..... | 1-4 |
| Vehicle modifications..... | 1-5 |

Introduction

Congratulations, and thank you for choosing HYUNDAI. We are pleased to welcome you to the growing number of discerning people who drive HYUNDAI. We are very proud of the advanced engineering and high quality construction of each HYUNDAI we build.

Your Owner's Manual will introduce you to the features and operation of your new HYUNDAI. To become familiar with your new HYUNDAI, so that you can fully enjoy it, read this Owner's Manual carefully before driving your new vehicle.

This manual contains important safety information and instructions intended to familiarize you with your vehicle's controls and safety features so you can safely operate your vehicle.

This manual also contains information on maintenance designed to enhance safe operation of the vehicle. It is recommended that all service and maintenance on your car be performed by an authorized HYUNDAI dealer. An authorized HYUNDAI dealer are prepared to provide high-quality service, maintenance, and any other assistance that may be required.

You may download an electronic version of this manual from owners.hyundaiusa.com.

HYUNDAI Motor America

Copyright 2023 HYUNDAI Motor America. All rights reserved. No part of this publication may be reproduced, stored in any retrieval system or transmitted in any form or by any means without the prior written permission of HYUNDAI Motor America.

Safety messages

Your safety, and the safety of others, are very important. This Owner's Manual provides you with many safety precautions and operating procedures. This information alerts you to potential hazards that may hurt you or others, and may damage your vehicle.

Safety messages found on vehicle labels and in this manual describe these hazards and what to do to avoid or reduce the risks.

Warnings and instructions contained in this manual are for your safety. Failure to follow safety warnings and instructions can lead to serious injury or death.

Throughout this manual DANGER, WARNING, CAUTION, NOTICE, and the SAFETY ALERT SYMBOL will be used.



This is the safety alert symbol. It is used to alert you to potential physical injury hazards. Obey all safety messages that follow this symbol to avoid possible injury or death. The safety alert symbol precedes the signal words DANGER, WARNING, and CAUTION.

DANGER

DANGER indicates a hazardous situation that, if not avoided, will result in death or serious injury.

WARNING

WARNING indicates a hazardous situation that, if not avoided, could result in death or serious injury.

CAUTION

CAUTION indicates a hazardous situation that, if not avoided, could result in minor or moderate injury.

NOTICE

NOTICE indicates a situation that, if not avoided, could result in vehicle damage.

Vehicle modifications

WARNING

Your HYUNDAI should not be modified in any way. Modifications may adversely affect the performance, safety or durability of your HYUNDAI and may, violate conditions of the limited warranties covering the vehicle. Certain modifications may also be in violation of safety and emissions regulations established by the U.S. Department of Transportation and other federal or state agencies.

If you use unauthorized electronic devices, it may cause the vehicle to operate abnormally, wire damage, battery discharge, and fire. For your safety, do not use unauthorized electronic devices.

NOTICE

Some vehicle interior sounds (including welcome chime, navigation alerts, or warning chimes) may be generated from the interior speakers or amplifier. Do not replace these components with anything other than the original Hyundai factory parts. Any unauthorized product may cause a malfunction of the vehicle interior sounds that may affect the intended operation of the vehicle.

2. Picture index

| | |
|-------------------------------------|-----|
| Exterior overview (Front view)..... | 2-2 |
| Exterior overview (Rear view)..... | 2-3 |
| Interior overview..... | 2-4 |
| Center console overview | 2-5 |
| Engine compartment overview | 2-6 |

Exterior overview (Front view)

Front view



The actual shape may differ from the illustration.

| | |
|---|------|
| (1) Hood | 5-48 |
| (2) Headlight | 9-56 |
| (3) Tires and wheels | 9-33 |
| (4) Side view mirror | 5-38 |
| (5) Sunroof | 5-44 |
| (6) Front windshield wiper blades | 9-28 |
| (7) Windows | 5-40 |
| (8) Front radar | 7-17 |

Exterior overview (Rear view)

Rear view



The actual shape may differ from the illustration.

| | |
|-----------------------------------|-------------|
| (1) Door | 5-25 |
| (2) Fuel filler door | 5-54 |
| (3) Rear combination light | 9-57 |
| (4) Trunk | 5-49 |
| (5) Defroster/Glass antenna | 5-88, 5-100 |
| (6) High mounted stop light | 9-60 |
| (7) Antenna | 5-100 |
| (8) Wide-rear view camera | 7-94 |

Interior overview

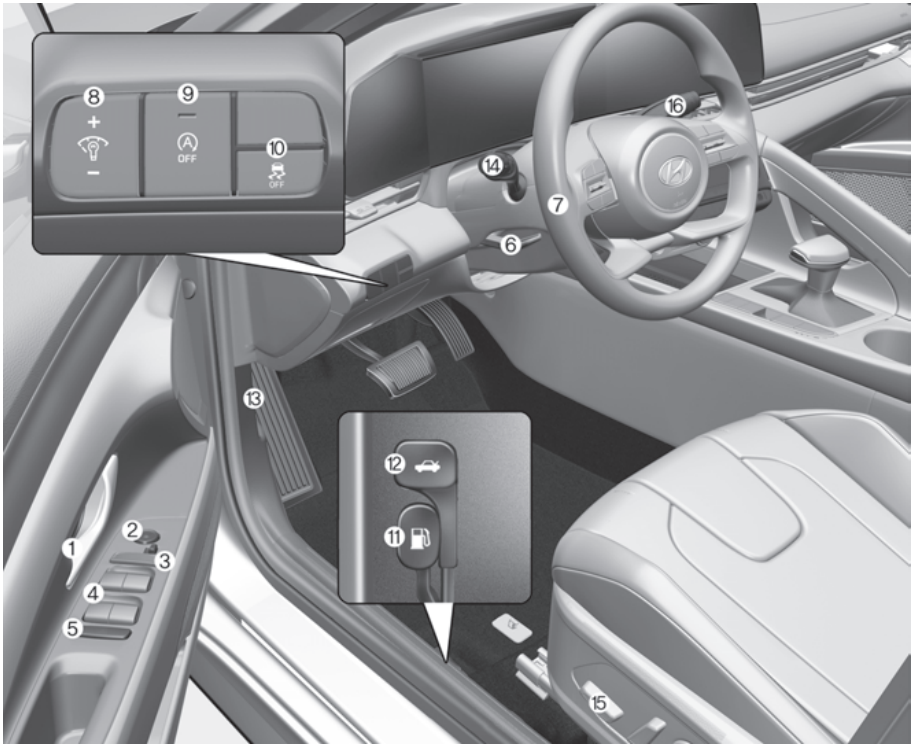

The actual shape may differ from the illustration.

| | |
|--|------|
| (1) Inside door handle | 5-26 |
| (2) Side view mirror control switch | 5-39 |
| (3) Central door lock switch | 5-25 |
| (4) Power window switches | 5-40 |
| (5) Power window lock button | 5-43 |
| (6) Steering wheel tilt/telescopic lever | 5-31 |
| (7) Steering wheel | 5-30 |
| (8) Instrument panel illumination control switch | 4-3 |
| (9) ISG (Idle Stop & Go) OFF button | 6-42 |
| (10) ESC OFF button | 6-38 |
| (11) Fuel filler door release lever | 5-54 |
| (12) Trunk release lever | 5-49 |
| (13) Hood release lever | 5-48 |
| (14) Light control/Turn signals | 5-56 |
| (15) Seat adjusting switch | 3-8 |
| (16) Wiper/washer switch | 5-65 |

Center console overview



The actual shape may differ from the illustration.

| | |
|---|------------|
| (1) Instrument cluster | 4-2 |
| (2) Driver's front air bag | 3-36 |
| (3) Engine start button | 6-9 |
| (4) Key ignition switch | 6-5 |
| (5) Infotainment system | 5-100 |
| (6) Hazard warning flasher switch | 8-2 |
| (7) Climate control system | 5-67, 5-77 |
| (8) Passenger's front air bag | 3-36 |
| (9) Glove box | 5-94 |
| (10) Intelligent variable transmission/Dual clutch transmission | 6-14, 6-20 |
| (11) Drive mode button | 6-49 |
| (12) Parking/View button | 7-95 |
| (13) Parking Safety button | 7-110 |
| (14) EPB (Electronic Parking Brake) switch | 6-31 |
| (15) AUTO HOLD button | 6-34 |
| (16) Drive mode button (for N Line vehicle) | 6-49 |

Engine compartment overview

Smartstream G 2.0 Atkinson

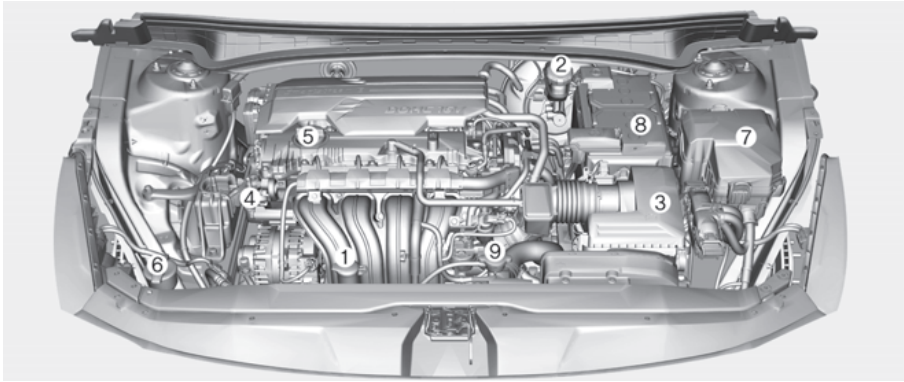

Smartstream G1.6 T-GDI

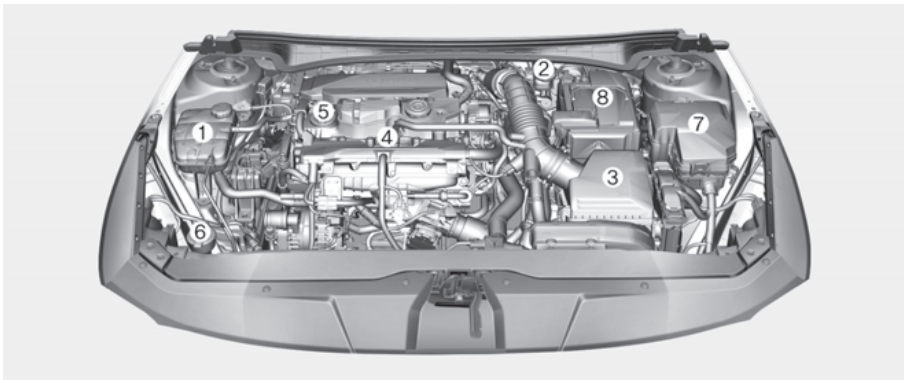

The actual engine room in the vehicle may differ from the illustration.

| | |
|---|------|
| (1) Engine coolant reservoir | 9-21 |
| (2) Brake fluid reservoir | 9-23 |
| (3) Air cleaner | 9-25 |
| (4) Engine oil dipstick | 9-19 |
| (5) Engine oil filler cap | 9-19 |
| (6) Windshield washer fluid reservoir | 9-25 |
| (7) Fuse box | 9-45 |
| (8) Battery | 9-29 |
| (9) Radiator cap | 9-21 |

3. Seats & safety system

This chapter provides you with important information about how to protect yourself and your passengers. It explains how to properly use your seats and seat belts, and how your airbags work.

Additionally, this chapter explains how to properly restrain infants and children in your vehicle.

- Important safety precautions 3-3
 - Always wear your seat belt..... 3-3
 - Restrain all children 3-3
 - Airbag hazards..... 3-3
 - Driver distraction 3-3
 - Never drink or take drugs and drive. 3-4
 - Control your speed 3-4
 - Keep your vehicle in proper operating condition - Inspecting your tires..... 3-4
- Seats 3-5
 - Safety precautions 3-6
 - Front seats 3-7
 - Rear seats 3-11
 - Head restraints..... 3-13
 - Seat warmers 3-17
- Seat belts..... 3-18
 - Seat belt safety precautions 3-18
 - Seat belt warning light..... 3-19
 - Seat belt restraint system..... 3-20
 - Additional seat belt safety precautions..... 3-25
 - Care of seat belts 3-27
- Child Restraint System (CRS) 3-27
 - Children always in the rear 3-27
 - Selecting a Child Restraint System..... 3-28
 - Installing a Child Restraint System 3-30
- Supplemental restraint system - airbags..... 3-36
 - SRS components..... 3-38
 - Where are the airbags? 3-39
 - How does the airbag system operate? 3-42
 - What to expect after an airbag inflates 3-44
 - SRS warning light..... 3-45
 - Occupant Classification System (OCS) 3-46
 - Why didn't my airbag go off in a collision? 3-51

| | |
|------------------------------------|------|
| SRS care | 3-55 |
| Additional safety precautions..... | 3-56 |
| Airbag warning labels..... | 3-56 |

Important safety precautions

You will find many safety precautions and recommendations throughout this section, and throughout this manual. The safety precautions in this section are among the most important.

Always wear your seat belt

A seat belt is your best protection in all types of accidents. Airbags are designed to supplement seat belts, not to replace them. So even though your vehicle is equipped with airbags, always make sure you and your passengers wear your seat belts, and wear them properly.

Restrain all children

All children under age 13 should ride in your vehicle properly restrained in a rear seat, not the front seat. Infants and small children should be restrained in an appropriate Child Restraint System. Larger children should use a booster seat with the lap/shoulder belt until they can use the seat belt properly without a booster seat.

Airbag hazards

While airbags can save lives, they can also cause serious or fatal injuries to occupants who sit too close to them, or who are not properly restrained. Infants, young children, and short adults are at the greatest risk of being injured by an inflating airbag. Follow all instructions and warnings in this manual.

Driver distraction

Driver distraction presents a serious and potentially deadly danger, especially for inexperienced drivers. Safety should be the first concern when behind the wheel and drivers need to be aware of the wide array of potential distractions, such as drowsiness, reaching for objects, eating, personal grooming, becoming distracted from other passengers, and using mobile phones.

Drivers can become distracted when they take their eyes and attention off the road or their hands off the wheel to focus on activities other than driving. To reduce your risk of distraction and an accident:

- Set up your mobile devices (for example, MP3 players, phones, navigation units, etc.) **ONLY** when your vehicle is safely stopped and parked.
- **ONLY** use your mobile device when allowed by laws and conditions permit safe use. **NEVER** text or email while driving. Most states have laws prohibiting drivers from texting while driving. Some states and cities also prohibit drivers from using handheld phones while driving.
- **NEVER** let the use of a mobile device distract you from driving. You have a responsibility to your passengers and others on the road to always drive safely, with your hands on the wheel as well as your eyes and attention on the road.

Never drink or take drugs and drive.

Drinking alcohol or taking drugs can reduce your ability to respond to changing conditions and emergencies. Do not drink or take drugs and drive, and do not let your friends drink or take drugs and drive.

Control your speed

Excessive speed is a major factor in crash injuries and deaths. Generally, the higher the speed, the greater the risk, but serious injuries can also occur at lower speeds. Never drive faster than is safe for current conditions, regardless of the maximum speed posted.

Keep your vehicle in proper operating condition - Inspecting your tires

Having a tire blowout or a mechanical failure can be extremely hazardous. To reduce the possibility of a tire hazard while driving, check your tire pressures regularly and also inspect the condition of your tires (tread depth, uneven wear, etc.). Be sure to perform all regularly scheduled maintenance as indicated in your Owner's Manual.

Seats

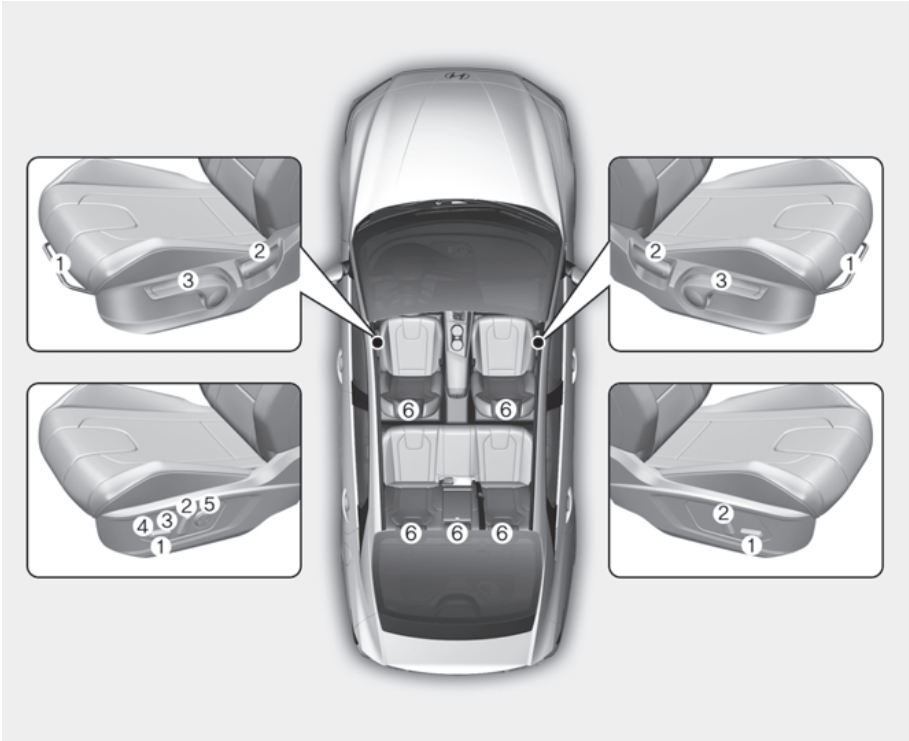

The information provided may differ depending on which functions are applicable to your vehicle.

- (1) Forward and rearward
- (2) Seatback angle
- (3) Seat height
- (4) Seat cushion angle
- (5) Lumbar support (Driver's seat)
- (6) Head restraint

Safety precautions

Adjusting the seats in a safe and comfortable position plays an important role for the safety of driver and passengers. Proper seating positions, secured seat belts, and protection from airbags work together to provide a measure of safety in the event of a collision.

WARNING

Do not use a cushion that reduces friction between the seat and the passenger. The passenger's hips may slide under the lap portion of the seat belt during an accident or a sudden stop.

Serious or fatal internal injuries could result because the seat belt cannot operate properly.

Airbags

You can take steps to reduce the risk of being injured by an inflating airbag. Sitting too close to an airbag greatly increases the risk of injury in the event the airbag inflates.

The National Highway Traffic Safety Administration (NHTSA) recommends that drivers allow at least 10 in. (25cm) between the center of the steering wheel and their chest.

WARNING

To reduce the risk of serious injury or death from an inflating airbag:

- Adjust the driver's seat as far to the rear as possible while maintaining your ability to control the vehicle.
 - Adjust the front passenger seat as far to the rear as possible.
 - Hold the steering wheel with hands at the 9 o'clock and 3 o'clock positions to minimize the risk of injuries to your hands and arms.
 - Never place anything or anyone between you and the airbag.
 - Do not allow the front passenger to place feet or legs on the dashboard to minimize the risk of leg injuries.
-

Seat belts

Always fasten your seat belt before starting any trip. At all times, passengers should sit upright and be properly restrained with a seat belt. Infants and small children must be restrained in appropriate Child Restraint Systems.

WARNING

To prevent serious injury or death:

- Never use one seat belt for more than one occupant.
 - Always position the seatback upright with the lap portion of the seat belt snug and low across the hips.
 - Never allow children or small infants to ride on a passenger's lap.
 - Do not route the seat belt across your neck, across sharp edges, or reroute the shoulder strap away from your body.
 - Do not allow the seat belt to become caught or jammed.
-

Front seats

WARNING

To prevent serious injury or death:

- Never attempt to adjust the seat while the vehicle is moving. The seat could respond with unexpected movement and may cause loss of vehicle control resulting in a collision.
- Do not place anything under the front seats. Loose objects, including unsecured floor mats, in the driver's foot area could interfere with the operation of the foot pedals.
- Do not allow anything to interfere with the normal position and proper locking of the seatback.
- Do not place a cigarette lighter on the floor or seat.
- Use extreme caution when picking up small objects trapped under the seats or between the seat and the center console. Your hands might be cut or injured by the sharp edges of the seat mechanism.
- If there are occupants in the rear seats, be careful while adjusting the front seat.
- Make sure that the seat is locked in place after the adjustment. If not, the seat might move unexpectedly.

Reclining seatback

Sitting in a reclined position when the vehicle is moving can be dangerous. Even when buckled up, the effectiveness of the restraint system (seat belts and/or airbags) is greatly reduced by reclining your seatback.

Seat belts must be snug against your hips and chest to work properly.

The more the seatback is reclined, the greater the chance for the passenger's hips to slide under the lap belt or the passenger's neck to strike the shoulder belt.

WARNING

Never ride with a reclined seatback when the vehicle is moving.

Riding with a reclined seatback increases your chance of serious or fatal injuries in the event of a collision or sudden stop.

Driver and passengers should always sit well back in their seats, properly belted, and with the seatbacks upright.

Seat belts must be snug against your hips and chest to work properly. When the seatback is reclined, the shoulder belt cannot do its job because it will not be snug against your chest. Instead, it will be in front of you. During a collision, you could be thrown into the seat belt, causing neck or other injuries.

The more the seatback is reclined, the greater chance the passenger's hips will slide under the lap belt or the passenger's neck will strike the shoulder belt.

Manual seats - Seat adjustments

 if equipped

The front seat can be adjusted by using the levers located underneath the front part of the seat or on the outer side of the seat.

Forward and rearward adjustment

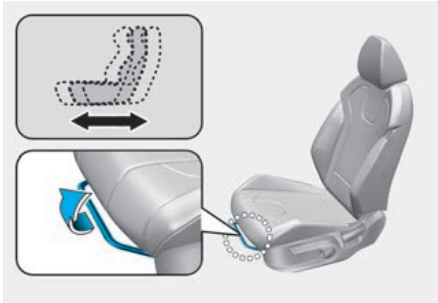

To move the seat forward or rearward:

1. Pull up the seat slide adjustment lever and hold it.
2. Slide the seat to the desired position.
3. Release the lever and make sure the seat is locked in place. Move forward and rearward without using the lever. If the seat moves, it is not locked properly.

Seatback angle

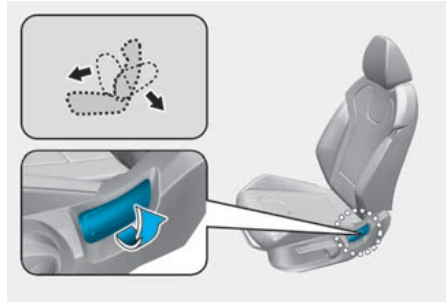

To recline the seatback:

1. Lean forward slightly and lift up the seatback lever.
2. Carefully lean back on the seat and adjust the seatback to the desired position.
3. Release the lever and make sure the seatback is locked in place.

Seat height (for driver's seat)

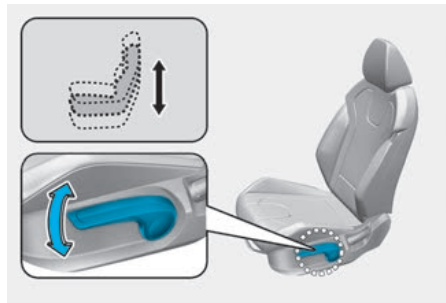

To change the height of the seat:

- Push down on the lever several times, to lower the seat.
- Pull up on the lever several times, to raise the seat.

Power seats - Seat adjustment

+ if equipped

The front seat can be adjusted by using the control switches located on the outside of the seat cushion.

⚠ WARNING

Never allow children to remain in the vehicle unattended. The power seats are operable when the vehicle is turned off.

NOTICE

To prevent damage to the seats:

- Always stop adjusting the seats when the seat has been adjusted as far forward or rearward as possible.
- Do not adjust the seats longer than necessary when the vehicle is turned off. This may result in unnecessary battery drain.
- Do not operate two or more seats at the same time. This may result in an electrical malfunction.

Forward and rearward adjustment

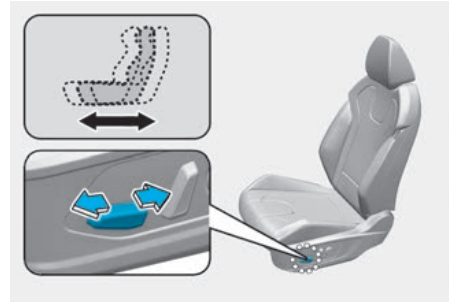

To move the seat forward or rearward:

1. Push the control switch forward or rearward.
2. Release the switch once the seat reaches the desired position.

Seatback angle

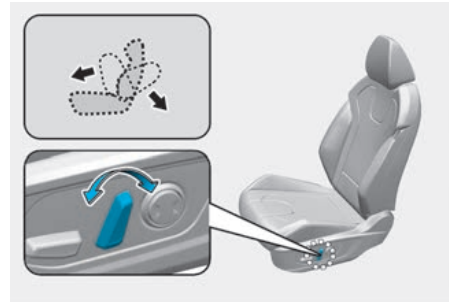

To recline the seatback:

1. Push the control switch forward or rearward.
2. Release the switch once the seatback reaches the desired position.

Seat cushion tilt (1)/Seat height (2)

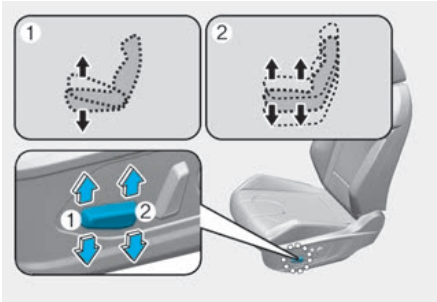

To change the angle of the front part of the seat cushion:

1. Push the front portion of the control switch up to raise or down to lower the front part of the seat cushion.
2. Release the switch once the seat reaches the desired position.

To change the height of the seat:

1. Push the rear portion of the control switch up to raise or down to lower the height of the seat.
2. Release the switch once the seat reaches the desired position.

Lumbar support (for driver's seat)

if equipped

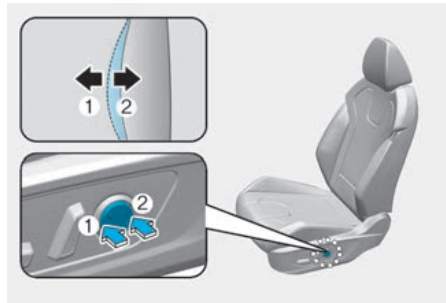

To adjust the lumbar support:

1. Press the front portion of the switch (1) to increase support or the rear portion of the switch (2) to decrease support.
2. Release the switch once the lumbar support reaches the desired position.

Seatback pocket

 if equipped

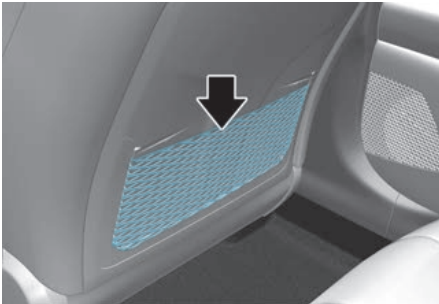

The seatback pocket is provided on the back of the front seatbacks.

WARNING

Do not put heavy or sharp objects in the seatback pockets. In a collision, they could come loose from the pocket and injure occupants.

Rear seats

Folding the rear seat

 if equipped

The rear seatbacks can be folded to facilitate carrying long items or to increase the luggage capacity of the vehicle.

WARNING

- Never allow passengers to sit on top of the folded down seatback while the vehicle is moving. This is not a proper seating position and no seat belts are available for use. This could result in serious injury or death in a collision or sudden stop.
- Objects carried on the folded down seatback should not extend higher than the top of the front seatbacks. This could allow cargo to slide forward and property damage or serious injury or even death during a collision or sudden stop.

To fold down the rear seatback:

1. Set the front seatback to the upright position and if necessary, slide the front seat forward.
2. Lower the rear head restraints to the lowest position by pushing and holding the release button and pushing down on the head restraint.

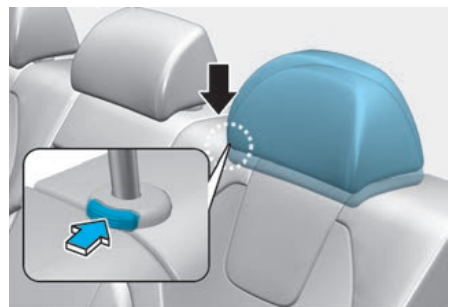

3. Pull out the seatback folding lever located in the trunk.



4. Fold the seatback toward the front of the vehicle.

Type A

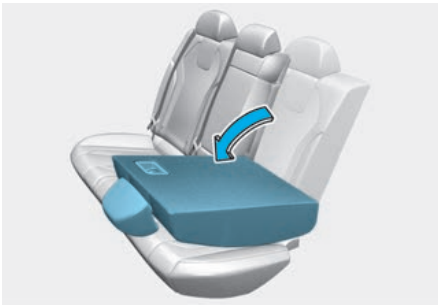

Type B

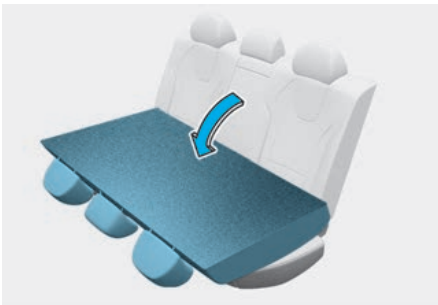

To use unfold the rear seatback:

1. Lift and push the seatback rearward.
2. Push the seatback firmly until it clicks into place. Make sure the seatback is locked in place.

WARNING

When returning the rear seatback from a folded to an upright position, hold the seatback and return it slowly. Lock the seatback properly. In a collision or sudden stop, an unlocked seatback may allow cargo to move forward with great force and may result in serious injury or death.

WARNING

Cargo should always be secured to prevent it from moving in a collision and causing serious injury or death to the vehicle occupants. Do not place objects in the rear seats, because they cannot be properly secured and may hit the front seat occupants in a collision.

WARNING

Make sure the engine is off, the vehicle is shifted to P (Park), and the parking brake is applied before loading or unloading cargo to prevent unintended movement of the vehicle.

Armrest

 if equipped



The armrest is located in the center of the rear seat. Pull the armrest down from the seatback to use it.

Head restraints

The vehicle's front and rear seats have adjustable head restraints. The head restraints are designed to help protect passengers from whiplash and other neck and spinal injuries during a collision, especially a rear impact collision. When there are no occupants in the rear seats, adjust the rear head restraints to the lowest height to improve the driver's visibility.

WARNING

To help reduce the risk of serious injury or death in an accident, take the following precautions when adjusting your head restraints:

- Always adjust the head restraints properly for all passengers BEFORE starting the vehicle.
- Never let anyone ride in a seat with the head restraints removed or reversed.
- Adjust the head restraints so that the middle of the head restraint is at the same height as the top of the eyes.

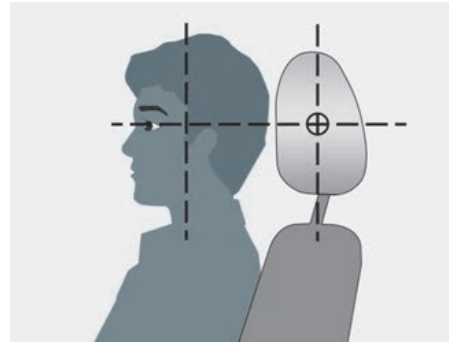

- Never adjust the driver's head restraint when the vehicle is moving.
- Make sure the head restraint is locked in place after adjustment.

Front seat head restraints

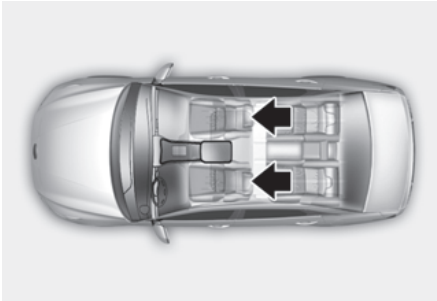

The driver's and front passenger's seats are equipped with adjustable head restraint for the passengers safety and comfort.

Adjusting the height up and down

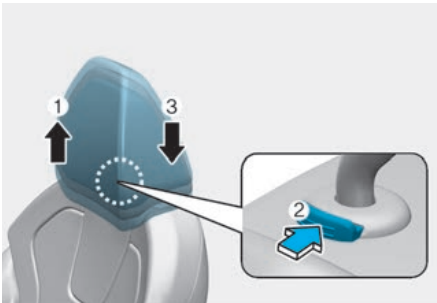

To raise the head restraint:

1. Pull it up to the desired position (1).

To lower the head restraint:

1. Press and hold the release button (2) on the head restraint support.
2. Lower the head restraint to the desired position (3).

Forward and rearward adjustment

if equipped



The head restraint can be adjusted forward to 3 different positions by pulling the head restraint forward to the desired detent. To adjust the head restraint to it's furthest rearwards position, pull it fully forward to the farthest position and release it.

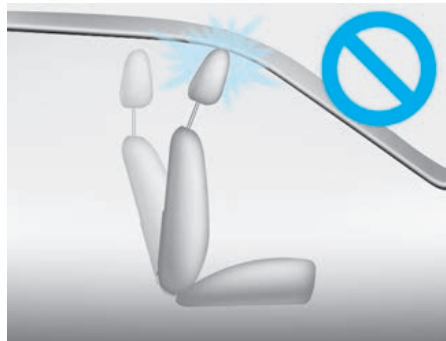

NOTICE

If you recline the seatback towards the front with the head restraint and seat cushion raised, the head restraint may come in contact with the sunvisor or other parts of the vehicle.

Removal/Reinstallation

Type A

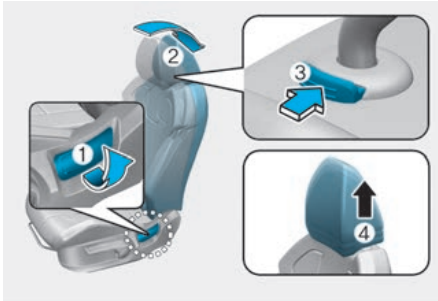

Type B

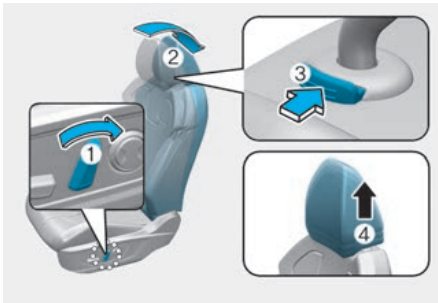

To remove the head restraint:

1. Recline the seatback (2) with the seatback angle lever or switch (1).
2. Raise the head restraint as far as it can go.
3. Press the head restraint release button (3) while pulling the head restraint up (4).

! WARNING

Never allow anyone to travel in a seat with the head restraint removed.

To reinstall the head restraint:

Type A

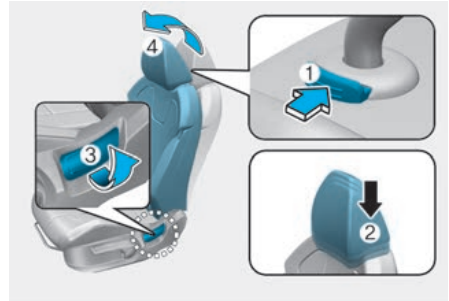

Type B

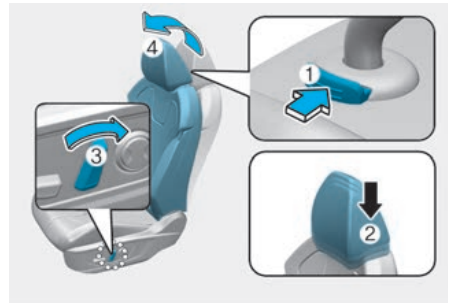

1. Recline the seatback.

2. Put the head restraint poles (2) into the holes while pressing the release button (1).
3. Adjust the head restraint to the appropriate height.
4. Return the seatback (4) with the seatback angle lever or switch (3).

! WARNING

Always make sure the head restraint is locked in place and properly adjusted for the passenger.

Rear seat head restraint

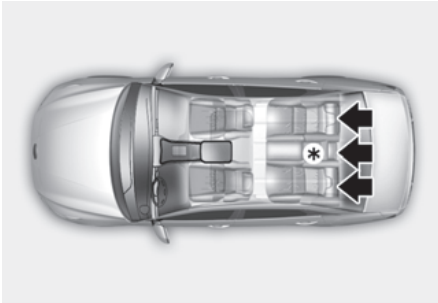

The rear seats are equipped with head restraint in all the seating positions for the passenger's safety and comfort.

Adjusting the height up and down

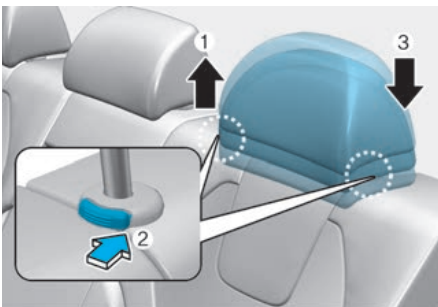

To raise the head restraint:

1. Pull it up to the desired position (1).

To lower the head restraint:

1. Press and hold the release button (2) on the head restraint support.
2. Lower the head restraint to the desired position (3).

Removal/Reinstallation

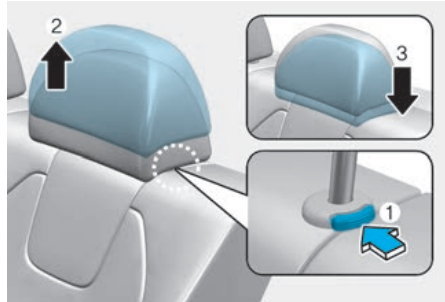

To remove the head restraint:

1. Raise the head restraint as far as it can go.
2. Press the head restraint release button (1) while pulling up the head restraint (2).

To reinstall the head restraint:

1. Put the head restraint poles into the holes (3) while pressing the release button (1).
2. Adjust the head restraint to the appropriate height.

Seat warmers

Front seat warmers

+ if equipped

Seat warmers are provided to warm the seats during cold weather.

During mild weather or under conditions where the operation of the seat warmer is not needed, keep the seat warmers off.

! WARNING

The seat warmers may cause serious burns, even at low temperatures and especially if used for long periods of time.

Passengers must be able to feel if the seat is becoming too warm so they can turn it off, if needed.

People who cannot detect temperature change or pain to the skin should use extreme caution, especially the following types of passengers:

- Infants, children, elderly or disabled persons, or hospital outpatients.
- People with sensitive skin or who burn easily.
- Fatigued individuals.
- Intoxicated individuals.
- People taking medication that may cause drowsiness or sleepiness.

Never place anything on the seat that insulates against heat when the seat warmer is operating, such as blanket or seat cushion.

NOTICE

To prevent damage to the seat warmers and seats:

- Never use a solvent such as paint thinner, benzene, alcohol, or gasoline to clean the seats.
- Do not place heavy or sharp objects on seats equipped with seat warmers.
- Do not change the seat cover.



While the engine is running, press the switches to warm the driver's seat or front passenger's seat.

- Manual temperature control
Press the button repeatedly to cycle through the seat warmer temperatures from high, medium, low, and off.
- Automatic temperature control
The seat warmer temperature is lowered automatically and then goes off after a certain time to prevent low temperature burns. If high temperature is selected again after the seat warmer turns off, the temperature is controlled automatically again.
- When pressing the switch for more than 1.5 seconds with the seat warmer operating, the seat warmer turns off.
- The seat warmer defaults to the OFF position whenever the ignition switch is in the ON position.

- Auto Comfort Control (for driver's seat) (if equipped)
 - The seat warmer automatically controls the seat temperature depending on the ambient temperature and the set climate control temperature when the engine is running. If the seat warmer switch is pressed, the seat warmer is controlled manually.
 - To use this feature, it can be enabled from the Settings menu in the infotainment system.
 - The seat warmer defaults to the OFF position whenever the ignition switch is ON. However, if the Auto Comfort Control function is on, the driver's seat warmer turns on and off depending on the ambient temperature and the set climate control temperature.

Seat belts

Seat belt safety precautions

Always fasten your seat belt and make sure all passengers have fastened their seat belts before starting any trip. Airbags are designed to supplement the seat belt as an additional safety device, not a replacement. Most states require all vehicle occupants wear seat belts.

WARNING

Seat belts must be used by ALL passengers whenever the vehicle is moving. To prevent serious injury or death:

- Children under the age of 13 should be properly restrained in the rear seats.
- Never allow children to ride in the front passenger seat. If a child age 13 or older must be seated in the front passenger seat, move the seat as far back as possible and properly restrain them in the seat.
- Never allow an infant or child to be carried on an occupant's lap.
- Never ride with the seatback reclined when the vehicle is moving.
- Do not allow children to share a seat or seat belt.
- Do not wear the shoulder belt under your arm or behind your back.
- Do not use the seat belt if it is twisted. A twisted seat belt may not protect you properly in a collision.
- Do not use a seat belt if the webbing or hardware is damaged. Have the seat belt replaced by an authorized HYUNDAI dealer.
- Do not latch the seat belt into the buckles intended for other seating positions.
- Never unfasten the seat belt while driving. This may cause loss of vehicle control resulting in a collision.

- Make sure there is nothing in the buckle that could interfere with the seat belt latch mechanism from fastening securely.
- Never modify seat belt or install devices that may prevent seat belt assembly from removing slack.

WARNING

Damaged seat belts and seat belt assemblies do not operate properly. Always replace:

- Frayed, contaminated, or damaged webbing.
- Damaged hardware.
- The entire seat belt assembly after it has been worn in an accident, even if damage to webbing or assembly is not apparent.

Seat belt warning light

Seat belt warning

Instrument cluster (Driver and front passenger's seat)



Driver's and Passenger's front seat belt warning

As a reminder, the seat belt warning light will illuminate for approximately 6 seconds each time you turn the ignition switch or Engine Start/Stop button is in the ON position regardless of belt fastening. If the seat belt is not fastened, the warning chime will sound for about 6 seconds.

If you start to drive without the seat belt fastened over approximately 5 mph (9 km/h) and less than approximately 12 mph (20 km/h), the corresponding warning light will illuminate. The warning light will turn off when the vehicle speed drops below approximately 5 mph (9 km/h).

If you start to drive without the seat belt fastened or you unfasten the seat belt when you drive approximately 12 mph (20 km/h) and faster, the warning light will blink and warning chime will sound for approximately 100 seconds.

When the seat belt is unfastened during driving, the warning light will illuminate when the speed is over approximately 5 mph (9 km/h) and less than approximately 12 mph (20 km/h). When the speed is approximately 12 mph (20 km/h) and faster, the warning light will blink and warning chime will sound for approximately 100 seconds.

Seat belt restraint system

WARNING

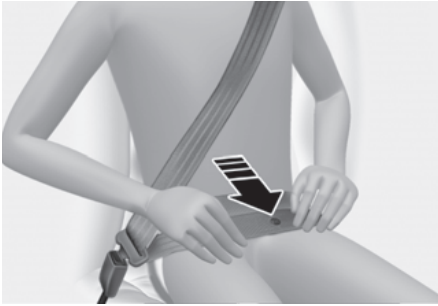

Improperly positioned seat belts may increase the risk of serious injury in an accident. Take the following precautions when adjusting the seat belt:

- Position the lap portion of the seat belt as low as possible across your hips, not on your waist, so that it fits snugly. This allows your strong pelvic bones to absorb the force of a collision, reducing the chance of internal injuries.
- Position one arm under the shoulder belt and the other over the belt, as shown in the illustration.
- Always position the shoulder belt anchor into the locked position at an appropriate height.
- Never position the shoulder belt across your neck or face.

Driver's seat belt – 3-point system with emergency locking retractor

To fasten your seat belt:

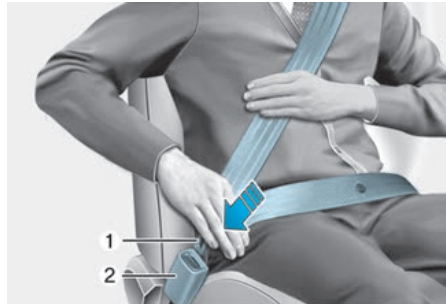

Pull the seat belt out of the retractor and insert the metal tab (1) into the buckle (2). An audible "click" sounds when the tab locks into the buckle. Make sure the seat belt is not twisted.

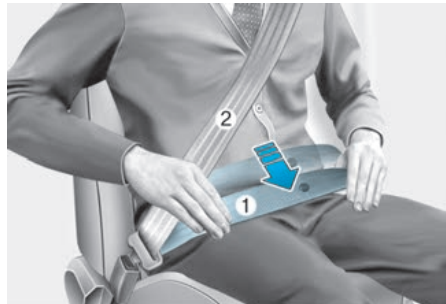

Place the lap belt (1) portion across your hips and the shoulder belt (2) portion across your chest.

The seat belt automatically adjusts to the proper length after the lap belt portion is adjusted manually so that it fits snugly around your hips. If you lean forward in a slow, easy motion, the belt extends and moves with you.

If there is a sudden stop or collision, the belt is locked in place. It also locks if you try to lean forward too quickly.

i Information

If you cannot smoothly pull the seat belt out from the retractor, firmly pull the seat belt out and release it. After release, the belt may be pulled out smoothly.

Height adjustment

Adjust the height of the shoulder belt so that it lies across your chest and midway over your shoulder nearest the door, not over your neck.

Front seat

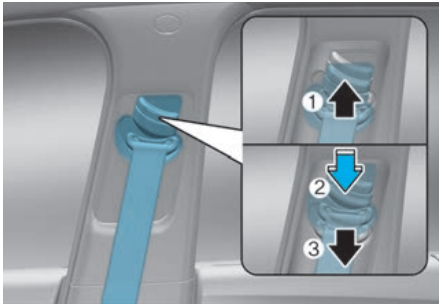

To adjust the height of the seat belt anchor:

Pull it up (1) to raise the height. To lower it, push it down (3) while pressing the height adjuster button (2).

Release the button to lock the anchor in place. Try pushing the height adjuster down to make sure that it is locked in place.

To release your seat belt:

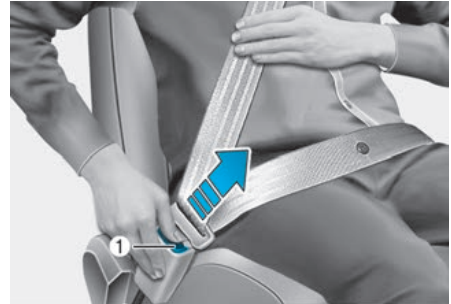

Press the release button (1) in the locking buckle.

The belt should automatically draw back into the retractor. If this does not happen, check the belt is not twisted, then try again.

Passenger and rear seat belts - 3-point system with convertible locking retractor

This type of seat belt combines both an emergency locking retractor and an automatic locking retractor. Convertible retractor type seat belts are installed in the rear seat positions to help accommodate the installation of child restraint systems.

A convertible retractor is also installed in the front passenger seat position. Children should always be seated in the rear. Never place any infant/child restraint system in the front seat.

To fasten your seat belt:

Pull the seat belt out of the retractor and insert the metal tab into the buckle. An audible "click" sounds when the tab locks into the buckle. Pull the shoulder portion of the belt to snug the belt across your hips and remove slack. Make sure the seat belt is not twisted.

When not securing a child restraint, the seat belt automatically adjusts to the proper length only after the lap belt portion of the seat belt is adjusted manually so that it fits snugly across your hips.

When the seat belt has been fully extended from the retractor to allow for the installation of a child restraint system, the seat belt operation changes to allow the belt to retract, but not to extend (Automatic Locking Retractor Type). Refer to the "Child Restraint System (CRS)" section in this chapter.

To release your seat belt:

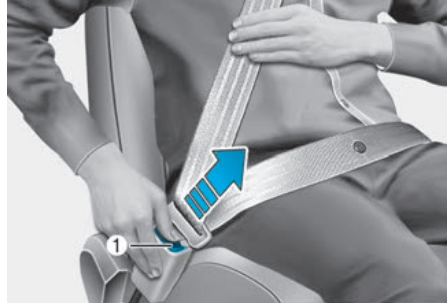

Press the release button (1) in the locking buckle.

The belt should automatically draw back into the retractor. If this does not happen, check the belt is not twisted, then try again.

i Information

- The emergency locking mode allows seated passengers to move freely in their seats while keeping some tension on the belt. During a collision or sudden stop, the retractor automatically locks the belt to help restrain the passengers.
 - To deactivate the automatic locking mode, unbuckle the seat belt and allow the belt to fully retract.
-

Second row center seat belt (3-point rear center seat belt)



Insert the tongue plate (1) into the buckle until an audible "click" is heard, indicating the latch is locked. Pull the shoulder portion of the belt to snug the belt across your hips and remove slack. Make sure the seat belt is not twisted.

When using the rear center seat belt, use the buckle with the "CENTER" mark.

i Information

If you cannot pull out the safety belt from the retractor, firmly pull the belt out and release it. After release, pull out the belt smoothly.

! WARNING

Make sure the seatback is locked in place when using the rear center seat belt.

If not secure, the seatback may move when there is a sudden stop or crash, and it may result in serious injury or death.

Pretensioner seat belt



Your vehicle is equipped with Pretensioner seat belts (retractor pretensioner). The pretensioner helps the driver's, front passenger's, and outboard rear seat belt fit tightly against your body in certain frontal or side collision(s).

When the vehicle stops suddenly, or if you try to lean forward too quickly, the seat belt retractor locks in place. In some frontal collisions, the pretensioner activates and pulls the seat belt against your body.

If the system senses excessive tension on the driver seat belt when the pretensioner system activates, the load limiter inside the retractor pretensioner releases some of the pressure on the affected seat belt.

! WARNING

To prevent serious injury or death:

- Always wear your seat belt and sit properly in your seat.
- Do not use the seat belt if it is loose or twisted.
- Do not place anything near the buckle.
- Always replace your pretensioner after activation or an accident.
- Have the pretensioner inspected, serviced, repaired, or replaced by only an authorized HYUNDAI dealer.
- Do not hit seat belt assemblies.

WARNING

Do not touch the pretensioner seat belt assemblies for several minutes after they have been activated. When the pretensioner seat belt mechanism deploys during a collision, the pretensioner can become hot and can burn you.

WARNING

Have the system serviced by an authorized HYUNDAI dealer. Body work on the front of the vehicle may damage the pretensioner seat belt system.

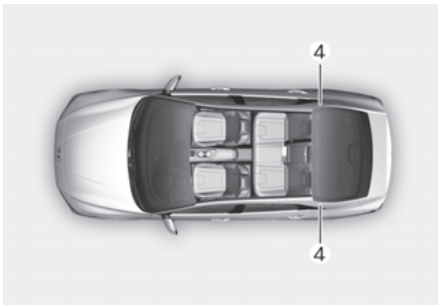
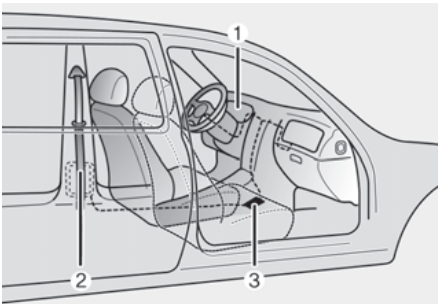

The Pre-Tensioner Seat Belt System consists mainly of the following components. Their locations are shown in the illustration above:

- (1) SRS airbag warning light
- (2) Front retractor pretensioner

- (3) SRS control module
- (4) Rear retractor pretensioner

The sensor that activates the SRS control module is connected with the pretensioner seat belt. The SRS airbag warning light on the instrument cluster illuminates for about 3-6 seconds after the ignition switch is in the ON position, and then it turns off.

If the pretensioner is not working properly, the warning light illuminates even if the SRS airbag is not malfunctioning. If the warning light does not illuminate when starting the engine or stays illuminated or illuminates while driving, have the pretensioner seat belts and/or SRS control module inspected by an authorized HYUNDAI dealer as soon as possible.

Information

- The pretensioner seat belt system may be activated in certain frontal or side collisions or rollover situations.
- When the pretensioner seat belts are activated, a loud noise may be heard and fine dust, which may appear to be smoke, may be visible in the passenger compartment.
- Although it is non-toxic, the fine dust may cause skin irritation and should not be inhaled for prolonged periods. Wash all exposed skin areas thoroughly after an accident in which the pre-tensioner seat belts were activated.

Additional seat belt safety precautions

Seat belt use during pregnancy

The seat belt should always be used during pregnancy. The best way to protect your unborn child is to protect yourself by always wearing the seat belt.

Pregnant women should always wear a lap-shoulder seat belt. Place the shoulder belt across your chest, routed between your breasts and away from your neck. Place the lap belt below your belly and pull the shoulder portion so it fits **SNUGLY** across your hips and pelvic bone, under the rounded part of your belly.

WARNING

- A pregnant woman is more vulnerable to any impacts on the abdomen during an abrupt stop or collision. If you are in an accident while pregnant, consult your doctor.
- To reduce the risk of serious injury or death to an unborn child during an accident, do not let pregnant women place the lap portion of the seat belt above or over the area of the abdomen where the unborn child is located.

Seat belt use and children

Infant and small children

All 50 states have Child Restraint System laws that require children to travel in approved Child Restraint System devices, including booster seats. The age at which seat belts can be used instead of Child Restraint System may be different, so you should be aware of the specific requirements in your state where you are traveling. Infant and Child Restraint System must be properly placed and installed in a rear seat.

For more information, refer to the "Child Restraint System (CRS)" section in this chapter.

WARNING

Always properly restrain infants and small children in a Child Restraint System appropriate for the child's height and weight.

To reduce the risk of serious injury or death to a child and other passengers, Never hold a child in your lap or arms when the vehicle is moving. Violent forces during a collision will tear the child from your arms and throw the child against the interior or to be ejected from the vehicle.

Small children are best protected from injury in an accident when properly restrained in the rear seat by a Child Restraint System that meets the requirements of the Federal Motor Vehicle Safety Standards. Before buying any Child Restraint System, make sure that it has a label certifying that it meets the applicable Safety Standards. The Child Restraint System must be appropriate for your child's height and weight. Check the label on the Child Restraint System for this information.

Refer to the "Child Restraint System (CRS)" section in this chapter.

Larger children

Children under age 13 and who are too large for a booster seat should always occupy the rear seat and use the available lap/shoulder belts. A seat belt should be snug against the hips and be snug across the shoulder and chest to restrain the child safely. A child's squirming could move the belt out of position. Adults should frequently check belt fit. In a collision, the safest place for children is in the rear seats, using a Child Restraint System appropriate for the child.

If a larger child over age 13 must be seated in the front seat, the child must be securely restrained by the available seat belt and the seat should be placed in the rearmost position.

If the shoulder belt portion slightly touches the child's neck or face, try placing the child closer to the center of the vehicle. If the shoulder belt still touches their face or neck, the child needs to return to an appropriate booster seat in the rear seat.

WARNING

- Always make sure children's seat belts are buckled and properly adjusted.
 - Never allow the shoulder belt to contact the child's neck or face.
 - Do not allow more than one child to use a single seat belt.
-

Seat belt use and injured people

A seat belt should still be used when an injured person is being transported. Consult a physician for specific recommendations.

One person per belt

When two people (children or adults) are sitting together, never attempt to use a single seat belt. This could increase the severity of injuries in a collision.

Do not lie down

Sitting in a reclined position when the vehicle is moving can be dangerous. Even when buckled up, the protections of your restraint system (seat belts and/or airbags) is greatly reduced by reclining your seatback.

Seat belts must be snug against your hips and chest to work properly.

During a collision, you could be thrown into the seat belt, causing neck or other injuries.

The more the seat back is reclined, the greater the chance for the passenger's hips to slide under the lap belt or the passenger's neck to strike the shoulder belt.

WARNING

- Never ride with a reclined seatback when the vehicle is moving.
 - Do not ride with a reclined seatback. It may increase your chance of serious or fatal injuries in the event of a collision or sudden stop.
 - Have the driver and all passengers always sit well back in their seats, properly belted, and with the seatbacks upright.
-

Care of seat belts

Seat belt systems should never be disassembled or modified.

Periodic inspection

All seat belts should be inspected periodically for wear or damage of any kind. Any damaged parts should be replaced as soon as possible.

Keep belts clean and dry

Seat belts should be kept clean and dry. If belts become dirty, they can be cleaned by using a mild soap solution and warm water. Bleach, dye, strong detergents, or abrasives should not be used because they may damage and weaken the fabric.

When to replace seat belts

The entire seat belt assembly or assemblies should be replaced if the vehicle has been involved in an accident. This should be done even if no damage is visible. Consult an authorized HYUNDAI dealer for assistance.

Child Restraint System (CRS)

Children always in the rear

WARNING

Always properly restrain children in the rear seats of the vehicle. Children of all ages are safer when restrained in the rear seat. A child riding in the front passenger seat can be forcefully struck by an inflating airbag resulting in serious injury or death.

Children under age 13 should always ride in the rear seats and must always be properly restrained to minimize the risk of injury in a collision, sudden stop, or sudden maneuver.

According to accident statistics, children are safer when properly restrained in the rear seat than in the front seat. **Even with airbags, children can be seriously injured or killed.** Children too large for a Child Restraint System must use the seat belts provided.

All 50 states have child restraint laws that require children to travel in approved Child Restraint Systems.

The laws governing the age or height/weight restrictions at which seat belts can be used instead of Child Restraint System differs among states, so you should be aware of the specific requirements where you are travelling.

Child Restraint Systems must be properly placed and installed in the rear seat. Use a commercially available Child Restraint System that meets the requirements of the Federal Motor Vehicle Safety Standards (FMVSS 213).

Child Restraint Systems are generally designed to be secured in a vehicle seat by a lap/shoulder seat belt, or by a LATCH system in the rear seats of the vehicle.

Child Restraint System

Infants and younger children must be restrained in an appropriate rearward-facing or forward-facing Child Restraint System that has first been properly secured to the rear seats of the vehicle. Read and comply with the instructions for installation and use provided by the manufacturer of the Child Restraint System.

WARNING

Do not use an improperly secured child restraint. It may increase the risk of serious injury or death in a collision.

When using a Child Restraint System:

- Never install a child or infant restraint in the front passenger's seat.
 - Always properly secure the Child Restraint System in the rear seat of the vehicle.
 - Always follow the Child Restraint System manufacturer's instructions for installation and use.
 - Always properly restrain your child in the Child Restraint System.
 - If the head restraint prevents proper installation of a child seat (as described in the Child Restraint System manual), readjust or remove the head restraint for that seating position.
 - Do not use an infant carrier or a child safety seat that "hooks" over a seatback. It may not provide adequate protection in an accident.
 - After an accident, have an authorized HYUNDAI dealer check the Child Restraint System, seat belts, tether anchors, and lower anchors.
-

Selecting a Child Restraint System

When selecting a Child Restraint System for your child, always:

- Make sure the Child Restraint System has a label certifying that it meets applicable Federal Motor Vehicle Safety Standards (FMVSS 213).
- Select a Child Restraint System based on your child's height and weight. The required label or the instructions for use typically provide this information.
- Select a Child Restraint System that fits the vehicle seating position where it is to be used.
- Read and comply with the warnings and instructions for installation and use provided with the Child Restraint System.

Child Restraint System types

There are three main types of Child Restraint Systems: rearward-facing, forward-facing, and booster seat Child Restraint Systems.

They are classified according to the child's age, height, and weight.

Rearward-facing Child Restraint System



With a rearward-facing Child Restraint System, the collision forces are absorbed by its shell instead of the child's body. The shell also supports the system's cradles and protects the head, neck and spine of the child. All children under the age of one year must always ride in a rearward-facing Child Restraint System. Convertible and 3-in-1 Child Restraint Systems typically have higher height and weight limits for the rearward-facing position, allowing you to keep your child rearward-facing for a longer period of time.

Continue using the Child Restraint Systems in the rearward-facing position as long as the child is within the height and weight limits allowed by the Child Restraint System's manufacturer. It's the best way to keep them safe. Once your child has outgrown the rearward-facing Child Restraint System, your child is ready for a forward-facing Child Restraint System with a harness.

WARNING

Never install a child or infant restraint in the front passenger's seat.

Placing a rearward-facing child restraint in the front seat may result in serious injury or death, if the child restraint is struck by an inflating airbag.

Forward-facing Child Restraint System



A forward-facing Child Restraint System provides restraint for the child's body with a harness. Keep children in a forward-facing Child Restraint System with a harness until they reach the top height or weight limit allowed by your Child Restraint System's manufacturer.

Once your child outgrows the forward-facing Child Restraint System, your child is ready for a booster seat.

Booster seats

A booster seat is a Child Restraint System designed to improve the fit of the vehicle's seat belt system. A booster seat positions the seat belt so that it fits properly over the lap of your child. Keep your children in booster seats until they are big enough to fit in a seat belt properly.

For a seat belt to fit properly, the lap belt must lie snugly across the upper thighs, not the stomach. The shoulder belt should lie snug across the shoulder and chest and not across the neck or face. Children under age 13 must always be properly restrained to minimize the risk of injury in an accident, sudden stop, or sudden maneuver.

Installing a Child Restraint System

WARNING

Before installing your Child Restraint System, always read and follow the instructions provided by the manufacturer of the Child Restraint System and in this manual to prevent serious injury or death if a collision occurs.

WARNING

If the vehicle head restraint prevents proper installation of a Child Restraint System, readjust or remove the head restraint for that seating position.

After selecting a proper Child Restraint System for your child and checking that the Child Restraint System fits properly in a rear seating position, there are three general steps for proper installation:

- **Properly secure the Child Restraint System to the vehicle.** All Child Restraint Systems must be secured to the vehicle with the a lap/shoulder belt or with a LATCH system in the rear seat of the vehicle.

Make sure the Child Restraint System is firmly secured. After installing a Child Restraint System in the vehicle, push and pull the seat forwards and backwards and from side to side to verify that it is securely attached to the seat. Install a Child Restraint System secured with a seat belt as tightly as possible. Some side-to-side movement can be expected.

- **Secure a child in the Child Restraint System.** Make sure the child is properly strapped in the Child Restraint System according to the Child Restraint System manufacturer's instructions.

CAUTION

Check the seating surface and buckles before placing your child in the Child Restraint System to prevent burns. A Child Restraint System in a closed vehicle can become very hot.

Lower anchors and tether for children (LATCH system)

The LATCH system connects a Child Restraint System to the vehicle during driving and in a collision. This system is designed to make installation of the Child Restraint System easier and reduce the possibility of improperly installing your Child Restraint System. The LATCH system uses anchors in the vehicle and attachments on the Child Restraint System. The LATCH system eliminates the need to use seat belts to secure the Child Restraint System to the rear seats.

Lower anchors are metal bars built into the vehicle. There are two lower anchors for each LATCH seating position that accommodates a Child Restraint System with lower attachments.

To use the LATCH system in your vehicle, install a Child Restraint System with LATCH attachments.

The Child Restraint System manufacturer provides you with instructions on how to use the Child Restraint System with its attachments for the LATCH anchors.

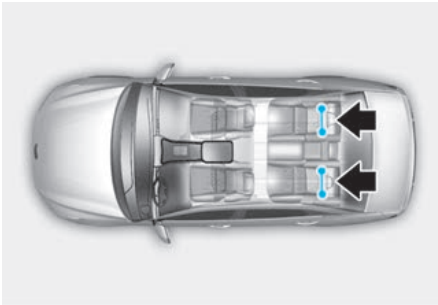

LATCH anchors have been provided in the left and right outboard rear seating positions. Their locations are shown in the illustration. There are no LATCH anchors provided for the center rear seating position.

WARNING

Do not attempt to install a Child Restraint System using LATCH anchors in the rear center seating position. There are no LATCH anchors provided for this seat. Do not use the outboard seat anchors for the center seat. It may damage the anchors that may break or fail in a collision resulting in serious injury or death.

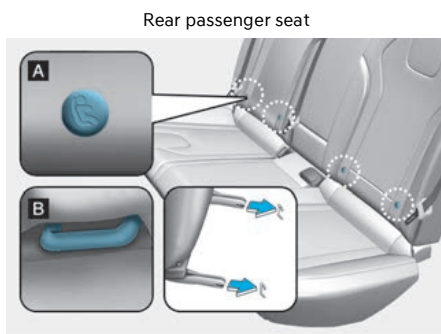

[A] Lower Anchor Position Indicator
[B] Lower Anchor

The lower anchor position indicator symbols are located on the left and right rear seatbacks to identify the positions of the lower anchors in your vehicle.

The LATCH anchors are located between the seatback and the seat cushion of the rear seat left and right outboard seating positions.

WARNING

Before installing the Child Restraint System, make sure that there are no objects (e.g. toys, pens, wires) near the lower anchor area. Those objects may damage either the seat belt system or the Child Restraint System during installation. If necessary, have the vehicle inspected by an authorized HYUNDAI dealer.

Securing a Child Restraint System with the LATCH anchors system

To install a LATCH-compatible Child Restraint System in either of the rear outboard seating positions:

1. Move the seat belt buckle away from the lower anchors.
2. Move any other objects away from the anchorages that could prevent a secure connection between the Child Restraint System and the lower anchors.
3. Place the Child Restraint System on the vehicle seat, then attach the seat to the lower anchors according to the instructions provided by the Child Restraint System manufacturer.
4. Follow the instructions of the Child Restraint System's manufacturer for proper installation and connection of the lower attachments on the Child Restraint System to the lower anchors.

WARNING

Take the following precautions when using the LATCH system:

- Read and follow all installation instructions provided with your Child Restraint System.
- To prevent the child from reaching and taking hold of unretracted seat belts, buckle all unused rear seat belts and retract the seat belt webbing behind the child. Children can be strangled if a shoulder belt becomes wrapped around their neck and the seat belt tightens.
- Never attach more than one Child Restraint System to a single anchorage. This could cause the anchor or attachment to come loose or break.
- Always have the LATCH system inspected by an authorized HYUNDAI dealer after a collision. A collision can damage the LATCH system and may not properly secure the Child Restraint System.

WARNING

Make sure that the combined weight of the child and the child restraint system is less than 65 lbs. (30 kg) for each LATCH system.

Securing a Child Restraint System seat with tether anchor system

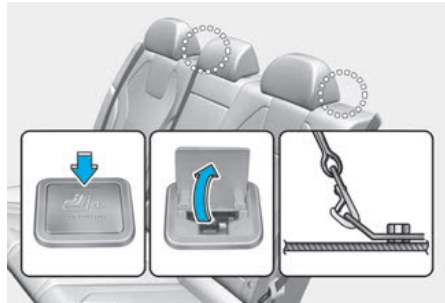

First secure the child restraint with the LATCH lower anchors or the seat belt. If the child restraint manufacturer recommends that the top tether strap be attached, attach and tighten the top tether strap to the top tether strap anchor.

Tether anchors are located on the package tray.

To install the tether anchor:



1. Route the Child Restraint System top-tether strap over the seatback. Placing the top tether strap, follow the instructions of the Child Restraint System manufacturer.
2. Connect the top-tether strap to the top-tether anchorage, then tighten the top-tether strap according to the instructions of your Child Restraint System's manufacturer to firmly attach the Child Restraint System to the seat.

3. Check the Child Restraint System is secure by pushing and pulling the seat forward and back and side-to-side.

WARNING

Take the following precautions when installing the top tether:

- Read and follow all installation instructions provided with your Child Restraint System.
- Never attach more than one Child Restraint System to a single tether anchor. This could cause the anchor or attachment to come loose or break.
- Only attach the tether strap to the correct tether anchor for that seating position.
- Make sure that the Child Restraint System anchors withstand the combined weight of the child and the child restraint system of less than 65 lbs. (30 kg) for each LATCH system.
Do not use them for adult seat belts, harnesses, or for attaching other items or equipment to the vehicle.

Securing a Child Restraint System with a lap/shoulder belt

WARNING

Always place a rearward-facing Child Restraint System in the rear seat of the vehicle.

Placing a rearward-facing child restraint in the front seat may result in serious injury or death if the Child Restraint System is struck by an inflating airbag.

When not using the LATCH system, all Child Restraint Systems must be secured to a rear seat using the lap/shoulder belt.

Automatic locking mode

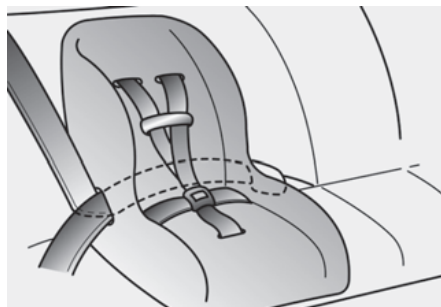

Since all passenger seat belts move freely under normal conditions and only lock under extreme or emergency conditions (emergency locking mode), you must manually pull the seat belt all the way out to shift the retractor to the Automatic Locking mode to secure a Child Restraint System.

The Automatic Locking mode will help prevent the normal movement of the child in the vehicle from causing the seat belt to loosen and compromise the Child Restraint System.

To install a Child Restraint System on the rear seats:

1. Place the Child Restraint System on a rear seat and route the lap/shoulder belt around or through the Child Restraint System, following the Child Restraint System manufacturer's instructions. Make sure the seat belt webbing is not twisted.

i Information

When using the rear center seat belt, refer to the "Passenger and rear seat belts - 3-point system with convertible locking retractor" section in this chapter.

2. Fasten the lap/shoulder belt latch into the buckle. Check a distinct "click" sound is heard.

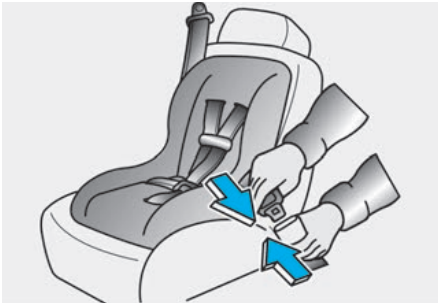

i Information

Position the release button so it is easy to access in an emergency.

3. Pull the shoulder portion of the seat belt all the way out. When the shoulder portion of the seat belt is fully extended, it shifts the retractor to the Automatic Locking (child restraint) mode.



4. Slowly allow the shoulder portion of the seat belt to retract and listen for an audible "clicking" or "ratcheting" sound. This indicates that the retractor is in the Automatic Locking mode. If no distinct sound is heard, repeat Step 3 and 4.



5. Remove as much slack from the belt as possible by pushing down on the Child Restraint System while feeding the shoulder belt back into the retractor.

6. Push and pull on the Child Restraint System to confirm that the seat belt is holding it firmly in place. If it is not, release the seat belt and repeat Step 2 through 6.
7. Double check that the retractor is in the Automatic Locking mode by attempting to pull more of the seat belt out of the retractor. If you cannot, the retractor is in the Automatic Locking mode.

If your Child Restraint System manufacturer instructs or recommends you to use a tether anchor with the lap/shoulder belt, refer to the previous pages for more information.

i Information

When the seat belt is allowed to retract to its fully stowed position, the retractor automatically switches from the Automatic Locking mode to the emergency lock mode for normal adult usage.

WARNING

Make sure that the retractor is in the Automatic Locking mode. Otherwise, the child restraint may move when your vehicle turns or stops suddenly. A child may be seriously injured or killed if the child restraint is not properly anchored in the vehicle including manually pulling the seat belt all the way out to shift the retractor to the Automatic Locking mode.

To remove the Child Restraint System, press the release button on the buckle and then pull the seat belt out of the Child Restraint System and allow the seat belt to retract fully.

Supplemental restraint system - airbags

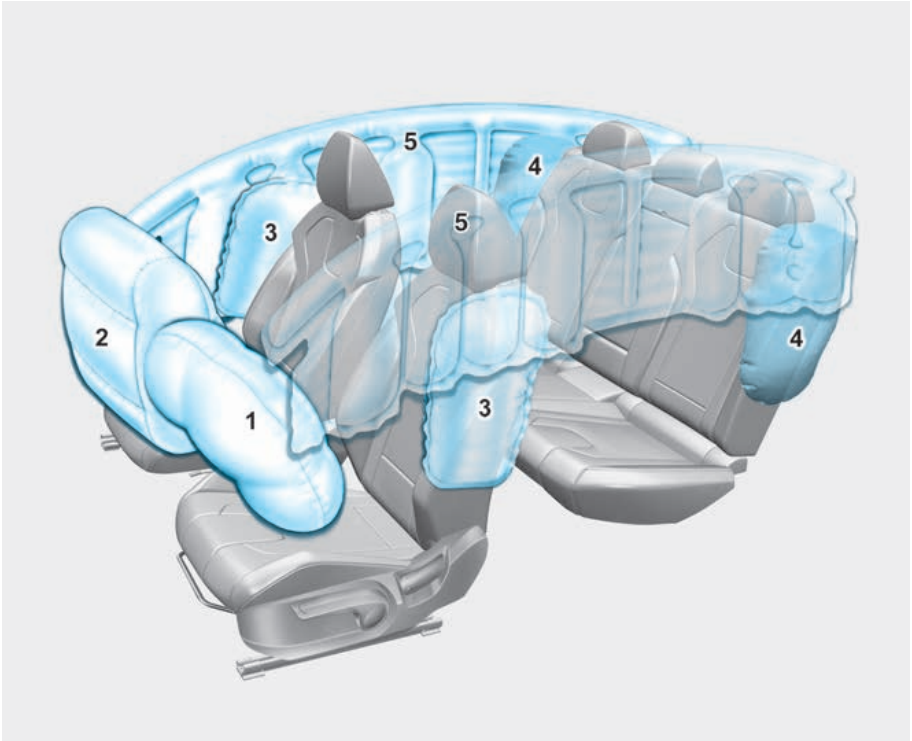

The actual airbags in the vehicle may differ from the illustration.

- (1) Driver's front airbag
- (2) Passenger's front airbag
- (3) Front side airbag
- (4) Rear side airbag
- (5) Curtain airbag

Your vehicle is equipped with a Supplemental Airbag System for the driver's seat and front passenger's seats.

The front airbags are designed to supplement the three-point seat belts. For these airbags to provide protection, seat belts must be properly worn at all times when driving. You can be severely injured or killed in an accident if you are not wearing a seat belt. Airbags are built into the vehicle as a supplementary system. They are not intended as a replacement for wearing 3-point seat belts. Also, airbags are not designed to deploy in every collision. In some accidents, the seat belts are the only restraint protecting you.

WARNING

AIRBAG SAFETY PRECAUTIONS

- Always use seat belts and Child Restraint Systems - every trip, every time, everyone! Even with airbags, you can be seriously injured or killed in a collision if you are improperly belted or not wearing your seat belt when the airbag inflates.
- Never place a child in any Child Restraint System or booster seat in the front passenger seat, unless the airbag is deactivated.
An inflating airbag could forcefully strike the infant or child causing serious or fatal injuries.
- ABC. Always Buckle Children under age 13 in the back seat. It is the safest place for children of any age to ride. If a child age 13 or older must be seated in the front seat, he or she must be properly belted and the seat should be moved as far back as possible.
- Make sure that all occupants sit upright with the seatback in an upright position, centered on the seat cushion with their seat belt on, legs comfortably extended, and their feet on the floor until the vehicle is parked and the vehicle is turned off. If an occupant is out of position during an accident, the rapidly deploying airbag may forcefully contact the occupant causing serious or fatal injuries.
- Never sit or lean unnecessarily close to the airbags or lean against the door or center console.

Move your seat as far back as possible from front airbags, while still maintaining control of the vehicle. The U.S. National Highway Traffic Safety Administration (NHTSA) recommends that drivers allow at least 10 in. (25 cm) between the center of the steering wheel and the chest.

SRS components

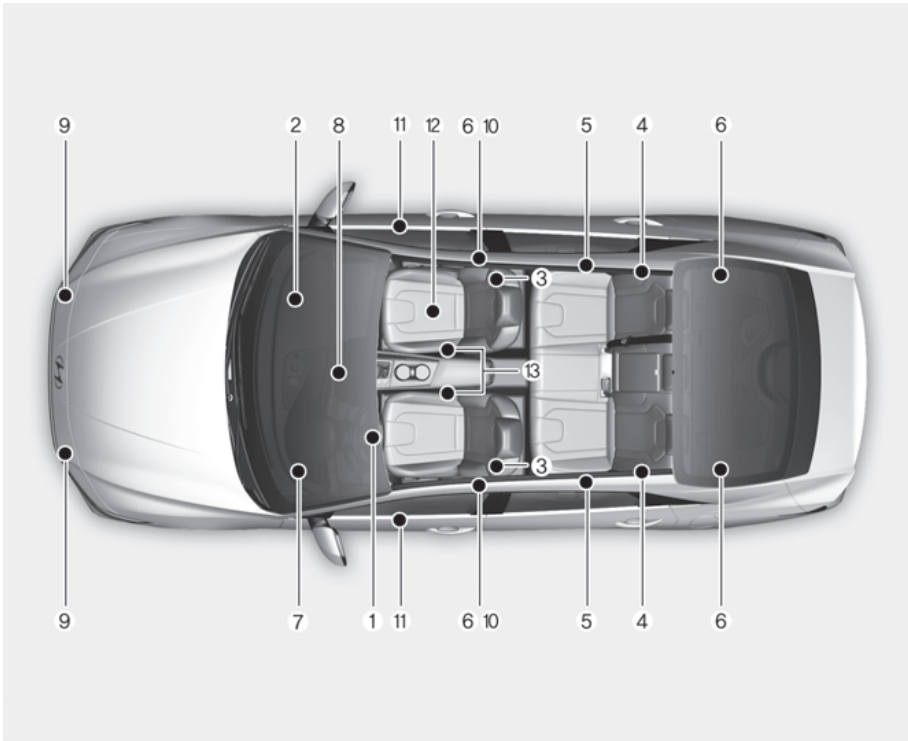

The SRS consists of the following components:

- (1) Driver's front airbag module
- (2) Passenger's front airbag module
- (3) Side airbag modules (front)
- (4) Side airbag modules (rear)
- (5) Curtain airbag modules
- (6) Retractor pretensioner (front and rear)
- (7) Airbag warning light
- (8) SRS control module (SRSCM)/Rollover sensor
- (9) Front impact sensors
- (10) Side impact sensors
- (11) Side pressure sensors
- (12) Occupant classification system
- (13) Driver's and front passenger's seat belt buckle sensors

Where are the airbags?

Driver's and passenger's front airbags

Driver's front airbag



Passenger's front airbag



The SRS consists of advanced airbags located in the center of the steering wheel and the passenger's side front panel above the glove box.

The airbag locations are embossed with the letters "AIRBAG".

The purpose of the SRS is to provide the vehicle's driver and front passenger with additional supplemental protection that the seat belt system does not provide in case of a frontal impact of sufficient severity.

The SRS uses sensors to gather information about the driver's and front passenger's seat belt usage and impact severity.

The seat belt buckle sensors determine if the driver and front passenger's seat belts

are fastened. These sensors provide the ability to control the SRS deployment based on whether or not the seat belts are fastened, and how severe the impact is.

The SRS offers the ability to control the airbag inflation within two levels. A first stage level is provided for moderate-severity impacts. A second stage level is provided for more severe impacts.

According to the impact severity and seat belt usage, the SRS Control Module (SRSCM) controls the airbag inflation. Failure to properly wear seat belts may increase the risk or severity of injury in a collision.

WARNING

To reduce the risk of serious injury or death from inflating front airbags:

- Seat belts must be worn at all times to help keep occupants positioned properly.
- Move your seat as far back as possible from front airbags, while still maintaining control of the vehicle.
- Never lean against the door or center console.
- Hold the steering wheel at the 9 o'clock and 3 o'clock positions, to minimize the risk of injuries to your hands and arms.
- Do not allow the front passenger to place their feet or legs on the dashboard.
- Never place any objects (such as dashboard cover, mobile phone holder, cup holder, perfume or stickers) over or near the airbag modules on the steering wheel, instrument panel, windshield glass, and the front passenger's panel above the glove box. Such objects may cause harm if the vehicle is in a collision severe enough to cause the airbags to deploy.
- Do not attach any objects on the front windshield and inside mirror.

Side airbags

Side airbags (Front seats)



Side airbags (Rear seat)

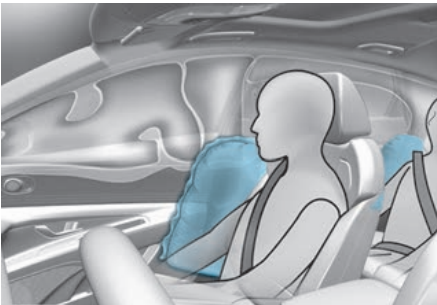

The side airbags are designed to deploy during certain side impact collisions, depending on the crash severity.

The side airbags on both sides of the vehicle are designed to deploy when a rollover is detected by a rollover sensor.

The side airbags are not designed to deploy in all side impact or rollover situations.

WARNING

To reduce the risk of serious injury or death from an inflating side airbag:

- Seat belts must be worn at all times to help keep occupants positioned properly.
- Do not allow passengers to lean their heads or bodies onto doors, put their arms on the doors, stretch their arms out of the window, or place objects between the doors and seats.
- Do not use any accessory seat covers. It may reduce or prevent the effectiveness of the system.
- Do not hang other objects except clothes. In an accident it may cause vehicle damage or personal injury especially when airbag is inflated.
- Do not place any objects over the airbag location or between the airbag and yourself. Also, do not attach any objects around the area the airbag inflates such as door, side door glass, and front and rear pillar.
- Do not place any objects between the door and the seat. They may become dangerous projectiles if the side airbag inflates.
- Do not install any accessories on the side or near the side airbags.
- Do not cause an impact to the doors when the ignition switch is in the ON or START position because the side airbags can inflate.
- If the seat or seat cover is damaged, have the vehicle serviced by an authorized HYUNDAI dealer.

Curtain airbags

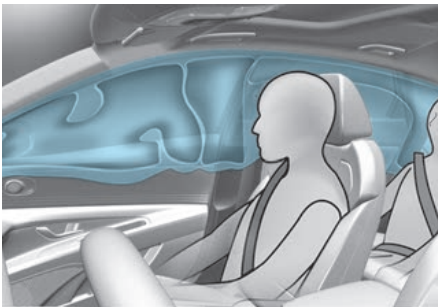

Curtain airbags are located along both sides of the roof rails above the front and rear doors.

They are designed to help protect the heads of the front seat occupants and the rear outboard seat occupants in certain side impact collisions.

The curtain airbags are designed to deploy during certain side impact collisions, depending on the crash severity.

For vehicles equipped with a rollover sensor the side and/or curtain airbags and pretensioners on both sides of the vehicle may deploy if a rollover or possible rollover is detected.

The curtain airbags are not designed to deploy in all side impact or rollover situations.

WARNING

To reduce the risk of serious injury or death from an inflating curtain airbag:

- All occupants must wear seat belts at all times to help keep occupants positioned properly.
- Properly secure a Child Restraint System as far away from the door as possible.
- Do not place any objects over the airbag. Also, do not attach any objects around the area the airbag inflates such as door, side door glass, front and rear pillar, and roof side rail.
- Do not hang other objects except clothes, especially hard or breakable objects near airbag locations. In an accident, it may cause vehicle damage or personal injury.
- Do not allow passengers to lean their heads or bodies onto doors, put their arms on the doors, stretch their arms out of the window, or place objects between the doors and seats.
- Do not open or repair the side curtain airbags.

How does the airbag system operate?

The SRSCM (Supplemental Restraint System Control Module) continually monitors all SRS components while the ignition switch is ON to determine if a crash impact is severe enough to require airbag deployment or pretensioner seat belt deployment.

During a moderate to severe frontal collision, sensors detect the vehicle's rapid deceleration. If the rate of deceleration is high enough, the SRSCM inflates the front airbags with the force needed.

The front airbags help protect the driver and front passenger by responding to frontal impacts in which seat belts alone cannot provide adequate restraint. When needed, the side airbags help provide protection in the event of a side impact or rollover by supporting the side upper body area.

- Airbags are activated (able to inflate if necessary) only when the ignition switch is in the ON or START position, and it may be activated within 3 minutes after the engine is turned off.
- Airbags inflate in the event of certain frontal or side collisions to help protect the occupants from serious physical injury.
- There is no single speed at which the airbags will inflate. Generally, airbags are designed to inflate based upon the severity of a collision and its direction. Airbag deployment also depends on a number of other factors including vehicle speed, angles of impact and the density and stiffness of the vehicles or objects which your vehicle impacts during a collision. The determining factors are not limited to those mentioned above.

- The front airbags completely inflate and deflate in an instant. It is virtually impossible for you to see the airbags inflate during an accident. It is much more likely that you simply see the deflated airbags hanging out of their storage compartments after the collision.
- In addition to inflating in serious side collisions, vehicles equipped with a rollover sensor, side and/or curtain airbags inflate if the sensing system detects a rollover.

When a rollover is detected, curtain airbags remain inflated longer to help provide protection from ejection, especially when used in conjunction with the seat belts, (if equipped with a rollover sensor).

- To help provide protection, the airbags must inflate rapidly. The speed of airbag inflation is a consequence of extremely short time in which the airbag inflates between the occupant and the vehicle structures before the occupant impacts those structures. This speed of inflation reduces the risk of serious or life-threatening injuries and is thus a necessary part of airbag design.

However, the rapid airbag inflation may also cause injuries that include facial abrasions, bruises, and broken bones because the inflation speed also causes the airbags to expand with great force.

- There are even circumstances under which contact with the airbag may cause fatal injuries, especially when the occupant is positioned excessively close to the airbag.

You can take steps to reduce the risk of being injured by an inflating airbag. The greatest risk is sitting too close to the airbag. An airbag needs about 10 in. (25 cm) of space to inflate. NHTSA recommends that drivers allow at least 10 in. (25 cm) between the center of the steering wheel and the chest.

WARNING

To reduce the risk of serious injury or death from an inflating airbag:

- Never place a child restraint in the front passenger seat.
Always properly restrain children under age 13 in the rear seats of the vehicle.
- Adjust the front passenger's and driver's seats as far to the rear as possible while maintaining you to maintain full control of the vehicle.
- Hold the steering wheel with hands at the 9 o'clock and 3 o'clock positions.
- Never place anything or anyone between the airbag and the seat occupant.
- Do not allow the front passenger to place their feet or legs on the dashboard.

Driver's front airbag (1)



When the SRSCM detects a sufficiently severe impact to the front of the vehicle, it automatically deploys the front airbags.

Driver's front airbag (2)



Upon deployment, tear seam in the pad cover separates from the expansion of the airbags.

A fully inflated airbag, in combination with a properly worn seat belt, slows the driver's or the front passenger's forward motion, reducing the risk of head and chest injury.

Driver's front airbag (3)



Passenger's front airbag



After complete inflation, the airbag immediately starts deflating, enabling the driver to maintain forward visibility and steer or operate other controls.

⚠ WARNING

To prevent objects from becoming dangerous projectiles when the passenger's airbag inflates:

- Do not install or place any objects (drink holder, CD holder, stickers, etc.) on the front passenger's panel above the glove box where the passenger's airbag is located.
- Do not install a container of liquid air freshener near the instrument cluster or on the instrument panel surface.

What to expect after an airbag inflates

After a frontal or side airbag inflates, it deflates very quickly. Airbag inflation does not prevent the driver from seeing out of the windshield or being able to steer. Curtain airbags may remain partially inflated for some time after they deploy.

⚠ WARNING

After an airbag inflates, take the following precautions:

- Open your windows and doors as soon as possible after impact to reduce prolonged exposure to the powder released by the inflating airbag.
- Do not touch the airbag storage area's internal components immediately after an airbag has inflated. The parts that come into contact with an inflating airbag may be very hot.
- Always wash exposed skin areas thoroughly with cold water and mild soap.
- Have an authorized HYUNDAI dealer inspect your vehicle and replace components as required before operating your vehicle again. Airbags are designed to be used only once.

Noise and powder from inflating airbag

When the airbags inflate, they make a loud noise and may release powder inside the vehicle. After the airbag inflates, you may feel discomfort while breathing. This may be due to the impact of the airbag or the seat belt with your chest and it may also be due to breathing residual powder in the air and around your vehicle. The powder may aggravate asthma for some people. If you experience breathing problems after an airbag deployment, seek medical attention immediately.

Though the powder is nontoxic, it may cause irritation to the skin, eyes, nose, throat, etc. If this is the case, wash and rinse with cold water immediately and seek medical attention if the symptoms persist.

SRS warning light



The SRS (Supplemental Restraint System) airbag warning light on the instrument panel displays the airbag symbol in the illustration. The light indicates if there is a potential problem with your airbag system, which could include your side and/or curtain airbags used for rollover protection.

⚠ WARNING

If your SRS malfunctions, the airbags may not inflate properly during a collision increasing the risk of serious injury or death.

Your SRS malfunctions in the following conditions:

- The light does not turn on for about three to six seconds when the ignition switch is in the ON position.
- The light stays on after illuminating for about three to six seconds.
- The light comes on while the vehicle is moving.
- The light blinks when the engine is running.

Have an authorized HYUNDAI dealer inspect the SRS as soon as possible.

Occupant Classification System (OCS)



Your vehicle is equipped with an Occupant Classification System (OCS) in the front passenger's seat.

Main components of the Occupant Classification System

- A detection device located within the front passenger seat cushion.
- Electronic system to determine whether the passenger airbag systems should be activated or deactivated.
- An indicator light located on the overhead console that illuminates the words "PASSENGER AIR BAG OFF" indicating the front passenger airbag system is deactivated.
- The instrument panel airbag indicator light is interconnected with the OCS.

The OCS is designed to help detect the presence of a properly seated front passenger and determine if the passenger's front airbag should be enabled (ready to inflate if required) or not.

The purpose is to help reduce the risk of injury or death from an inflating airbag to certain front passenger seat occupants, such as children, by requiring the airbag to be automatically turned off.

For example, if a Child Restraint System is installed on the seat, the Occupant Classification System can detect it and turn off the front passenger airbag.

Front passenger seat adult occupants who are properly seated and wearing the seat belt properly, should not cause the passenger airbag to be automatically turned off. For smaller adults, it may turn off. However, if the occupant does not sit in the seat properly (for example, not sitting upright, sitting on the edge of the seat, or being out of position), this may cause the sensor to turn the front passenger airbag off.

You can find the "PASSENGER AIR BAG OFF" indicator on the overhead console panel. This system detects one of the four conditions as described in the following table and activates or deactivates the front passenger airbag based on these conditions.

Always make sure that you and all occupants are seated properly and wearing the seat belt properly for the most effective protection by the airbag and the seat belt.

Condition and operation in the front passenger Occupant Classification System

| Condition detected by the occupant classification system | Indicator/Warning light | | Devices |
|--|---|-------------------|------------------------|
| | "PASSENGER AIR BAG OFF" indicator light | SRS warning light | Front passenger airbag |
| Adult ^{*1} | Off | Off | Activated |
| Infant ^{*2} or child restraint system with 12 months old ^{*3 *4} | On | Off | Deactivated |
| Unoccupied | On | Off | Deactivated |
| Problems with OCS | Off | On | Activated |

*1 The system judges a person of adult size as an adult. When a smaller adult sits in the front passenger seat, the system may recognize him/her as a child depending on his/her physique and posture.

*2 Do not allow children to ride in the front passenger seat. When a larger child who has outgrown a Child Restraint System sits in the front passenger seat, the system may recognize him/her as an adult depending on his/her physique or sitting position.

*3 Never install a Child Restraint System on the front passenger seat.

*4 The "PASSENGER AIR BAG OFF" indicator may turn ON or OFF when a child above 12 months to 12 years old (with or without Child Restraint System) sits in the front passenger seat. This is a normal condition.

⚠ WARNING

Riding in an improper position or placing weight on the front passenger's seat when it is unoccupied by a passenger, adversely affects the OCS. To reduce the risk of serious injury or death:

- Never put a heavy load in the front seat or seatback pocket, or hang any items on the front passenger seat.



- Never place your feet on the front passenger seatback.

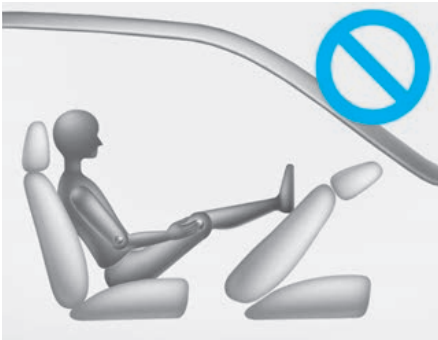

- Never sit with your hips shifted toward the front of the seat.



- Never ride with the seatback reclined when the vehicle is moving.



- Never place your feet or legs on the dashboard.



- Never lean on the door or center console or sit on one side of the front passenger seat.



- Do not use car seat accessories such as thick blankets and cushions that cover up the car seat surface.



- Do not sit on the passenger seat wearing heavily padded clothes such as ski wear and hip protector.



- Do not place electronic devices such as laptops, DVD player, or conductive materials such as water bottles on the front passenger seat.
- Do not use electronic devices such as laptops and satellite radios that use inverter chargers when seated in the front passenger seat.



- Make sure the seat has been completely dried before driving the vehicle. If large quantity of liquid has been spilled on the front passenger seat, the airbag warning light may illuminate or malfunction.



- Do not place sharp objects on the front passenger seat. These may damage the occupant detection system, if they puncture the seat cushion.
- Do not place any items under the front passenger seat.
- When changing or replacing the seat or seat cover, use original items only. The OCS has been developed based on using original HYUNDAI car seats only. Altering or changing the authentic parts may result in system malfunction and increase risk of injury in a collision. Any of the above may interfere with the proper operation of the OCS sensor thereby increasing the risk of an injury in an accident.

Proper seated position for OCS

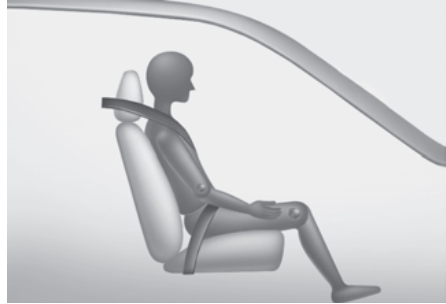

If the "PASSENGER AIR BAG OFF" indicator is on when an adult is seated in the front passenger seat, move the ignition switch to the OFF position and ask the passenger to sit properly (sitting upright with the seatback in an upright position, centered on the seat cushion with their seat belt on, legs comfortably extended, and their feet on the floor). Restart the engine and have the person remain in that position. This allows the system to detect the person and to enable the passenger airbag. If the "PASSENGER AIR BAG OFF" indicator is still on, ask the passenger to move to the rear seat.

WARNING

Never allow an adult passenger to ride in the front passenger seat when the "PASSENGER AIR BAG OFF" indicator is illuminated. During a collision, the airbag does not inflate if the indicator is illuminated. If the indicator is illuminated while an adult is seated in the front passenger seat, follow the steps in the previous paragraph to have the passenger reposition themselves in the seat.

If the "PASSENGER AIR BAG OFF" indicator remains illuminated after the passenger sits in the proper seating position, have the passenger sit in the rear seat of the vehicle instead.

i Information

The "PASSENGER AIR BAG OFF" indicator generally illuminates for about 4 seconds after the ignition switch is in the ON or START position. But, if the ignition switch is in the ON or START position within 3 minutes after the engine is turned OFF, the indicator does not illuminate. If the front passenger seat is occupied, the OCS classifies the front passenger after several seconds.

Do not install a Child Restraint System on the front passenger's seat



Even though your vehicle is equipped with the OCS, never install a Child Restraint System in the front passenger's seat. An inflating airbag may forcefully strike a child or child restraint resulting in serious or fatal injury.

! WARNING

Never use a rearward facing Child Restraint on a seat protected by an ACTIVE AIRBAG in front of it. It may result in death or serious injury to the CHILD. Children should always ride in the rear seats.

Why didn't my airbag go off in a collision?

There are certain types of accidents in which the airbag would not deploy including rear impacts and second or third collisions in multiple impact accidents, as well as low speed impacts. Damage to the vehicle indicates a collision energy absorption, and is not an indicator of whether or not an airbag should have inflated.

Airbag collision sensors

! WARNING

To reduce the risk of an airbag deploying unexpectedly and causing serious injury or death:

- Do not hit or allow any objects to impact the locations where airbags or sensors are installed.
- Do not perform maintenance on or around the airbag sensors. If the location or angle of the sensors is changed, the airbags may deploy when they should not or may not deploy.
- Do not install bumper guards with non genuine Hyundai or non-equivalent parts. It may adversely affect the collision and airbag deployment performance.
- Move the ignition switch to the OFF or ACC position and wait for 3 minutes before the vehicle is towed to prevent unintended airbag deployment.
- Have all airbag repairs are conducted by an authorized HYUNDAI dealer.



- (1) SRS control module/Rollover sensor
- (2) Front impact sensor
- (3) Side impact sensors (Acceleration)
- (4) Side impact sensors (Pressure)

Airbag inflation conditions

Front airbags

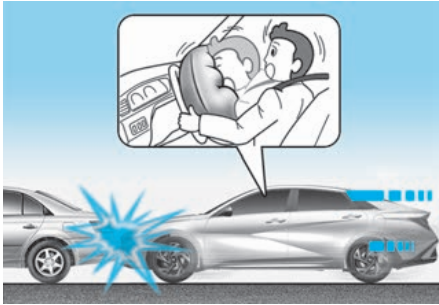

Front airbags are designed to inflate in a frontal collision depending on the severity of impact.

Side and curtain airbags

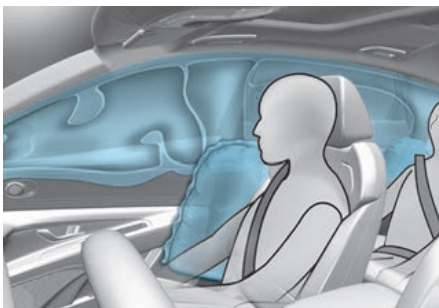
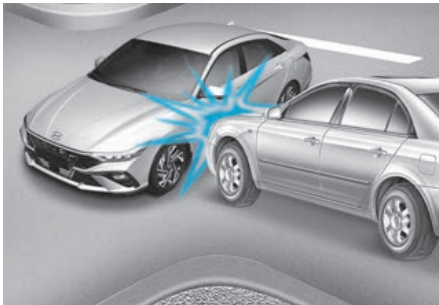

Side and curtain airbags are designed to inflate when an impact is detected by side collision sensors depending on the

severity of impact resulting from a side impact collision.

Although the driver's and front passenger's airbags are designed to inflate in frontal collisions and side and curtain airbags are designed to inflate in side impact collisions, airbags may inflate in other types of collisions if the sensors detect a sufficient impact.

Also, the side and curtain airbags inflate when a rollover is detected by a rollover sensor.

If the vehicle chassis is impacted by bumps or objects on unimproved roads, the airbags may deploy. Drive carefully on unimproved roads or on surfaces not designed for vehicle traffic to prevent unintended airbag deployment.

Airbag non-inflation conditions

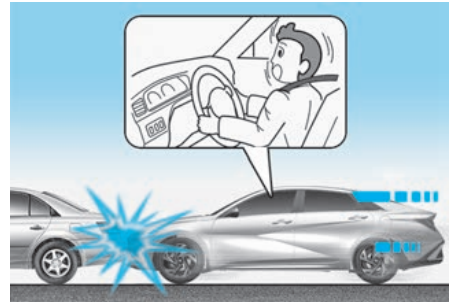

In certain low-speed collisions, the airbags may not deploy. The airbags are designed not to deploy in such cases because they may not provide benefits beyond the protection of the seat belts.



Front airbags are not designed to inflate in rear collisions, because occupants are moved backward by the force of the impact.

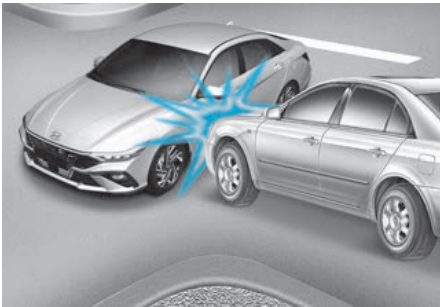

Front airbags may not inflate in side impact collisions, because occupants move in the direction of the collision. Side and curtain airbags may inflate depending on the severity of impact.

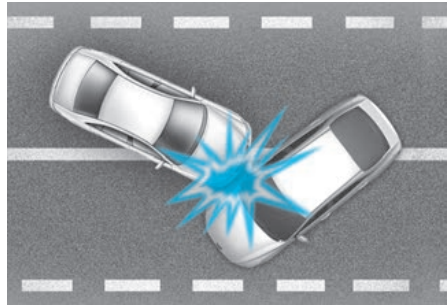

In an angled collision, the force of impact may direct the occupants in a direction where the airbags would not be able to provide any additional benefit, and thus the sensors may not deploy any airbags.

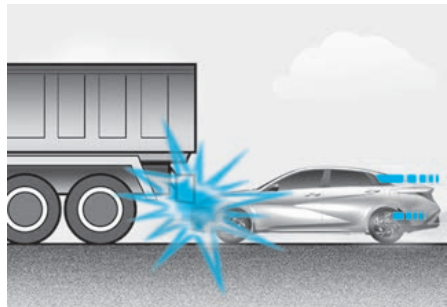

Just before impact, drivers often brake heavily. Such heavy braking lowers the front portion of the vehicle causing it to "nosedive". This is particularly important when the vehicle in front has a higher ground clearance. Airbags may not inflate if your vehicle is in a "nosedive" condition because the collision forces detected by the sensors may have been significantly reduced.

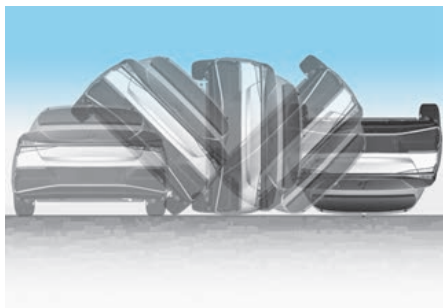

Front airbags may not inflate in rollover accidents because front airbag deployment would not provide additional occupant protection.

The side and curtain airbags may inflate in a rollover situation, when detected by the rollover sensor.



Airbags may not inflate if the vehicle collides with objects such as utility poles or trees, where the point of impact is concentrated and the collision energy is absorbed by the vehicle structure.

SRS care

The SRS is virtually maintenance-free and there are no parts you can safely service by yourself. If the SRS airbag warning light does not illuminate when the ignition switch is in the ON position or continuously remains on, have the system immediately inspected by an authorized HYUNDAI dealer.

Any work on the SRS system, such as removing, installing, repairing, or any work on the steering wheel, the front passenger's panel, front seats, and roof rails should be performed by an authorized HYUNDAI dealer. Improper handling of the SRS system may result in serious personal injury or death.

WARNING

To reduce the risk of serious injury or death:

- Do not attempt to modify or disconnect the SRS components or wiring, including the addition of any kind of badges to the pad covers or modifications to the body structure.
- Do not place objects over or near the airbag modules on the steering wheel, instrument panel, and the front passenger's panel above the glove box.
- Clean the airbag pad covers with a soft cloth moistened with water. Solvents or cleaners may adversely affect the airbag covers and proper deployment of the system.
- Replace inflated airbags by an authorized HYUNDAI dealer.
- If components of the airbag system must be discarded, or if the vehicle must be scrapped, observe safety precautions. Consult an authorized HYUNDAI dealer for the necessary information.

Additional safety precautions

Passengers should not move out of or change seats while the vehicle is moving. A passenger who is not wearing a seat belt during a collision or emergency stop can be thrown against the inside of the vehicle, against other occupants, or be ejected from the vehicle.

Do not use any accessories on seat belts.

Devices claiming to improve occupant comfort or reposition the seat belt can reduce the protection provided by the seat belt and increase the chance of serious injury in a collision.

Do not modify the front seats.

Modification of the front seats may interfere with the operation of the Supplemental Restraint System sensing components or side airbags.

Do not place items under the front seats.

Placing items under the front seats may interfere with the operation of the Supplemental Restraint System sensing components and wiring harnesses.

Do not cause impact to the doors.

Impact to the doors when the ignition switch is in the ON or START position may cause the airbags to inflate.

Modifications to accommodate

disabilities. If you require modification to your vehicle to accommodate a disability, contact the HYUNDAI Customer Connect Center at 800-633-5151.

Adding equipment to or modifying your airbag equipped vehicle

If you modify your vehicle by changing your vehicle's frame, bumper system, front end or side sheet metal, or ride height, this may affect the operation of your vehicle's Supplemental Restraint System.

Airbag warning labels



Airbag warning labels, required by the U.S. National Highway Traffic Safety Administration (NHTSA), are attached to alert the driver and passengers of potential risks of the airbag system. Be sure to read all of the information about the airbags that are installed on your vehicle in this Owners Manual.

4. Instrument Cluster

| | |
|--|------|
| Instrument cluster | 4-2 |
| Instrument cluster control..... | 4-3 |
| Gauges and meters..... | 4-3 |
| Transmission shift indicator | 4-8 |
| Warning and indicator lights | 4-8 |
| Cluster display messages | 4-19 |
| Cluster display (Type A) | 4-23 |
| Cluster display control..... | 4-23 |
| Cluster display modes | 4-24 |
| User settings mode..... | 4-27 |
| Trip computer..... | 4-35 |
| Cluster display (Type B) | 4-37 |
| Cluster display control..... | 4-37 |
| View modes..... | 4-38 |
| Vehicle settings (infotainment system) | 4-41 |
| Setting your vehicle | 4-41 |

Instrument cluster

Conventional cluster (Type A)

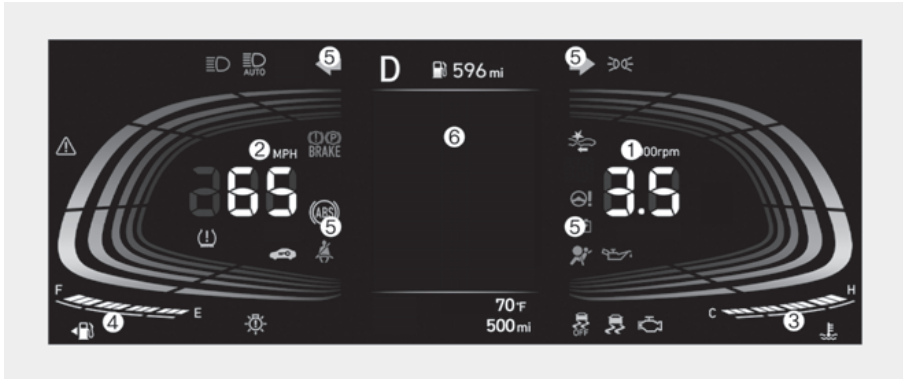

Full LCD cluster (Type B)

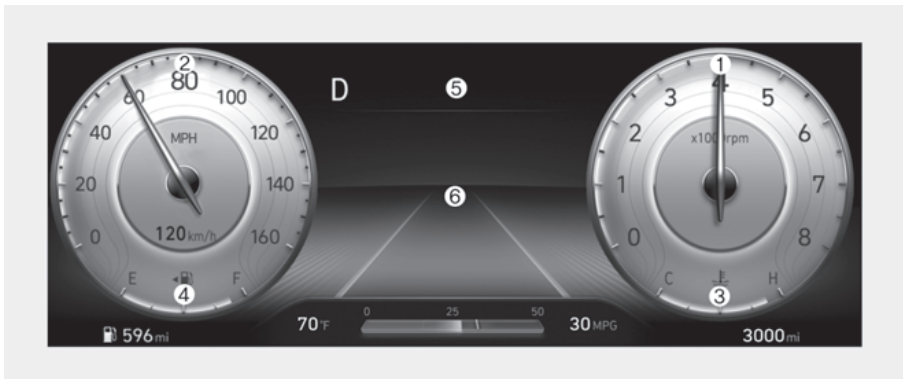

The actual cluster in the vehicle may differ from the illustration.
For more information, refer to the "Gauges and meters" in this chapter.

- (1) Tachometer
- (2) Speedometer
- (3) Engine coolant temperature gauge
- (4) Fuel gauge
- (5) Warning and indicator lights
- (6) Cluster display (including trip computer)

Instrument cluster control

Adjusting instrument cluster illumination

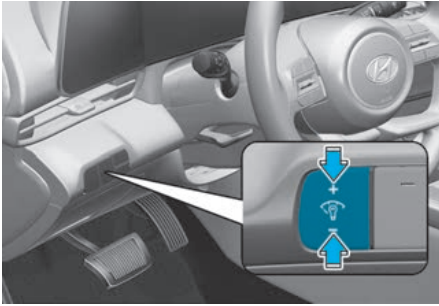

When the vehicle's parking lights or headlights are on, press the illumination control button to adjust the brightness of the instrument panel illumination.

When pressing the illumination control button, the interior switch illumination intensity is also adjustable.

- The brightness of the instrument panel illumination is displayed.
- When the brightness setting reaches either the minimum or maximum level, a chime sounds.

WARNING

Never adjust the instrument cluster while driving to prevent death, serious injury, or vehicle damage.

Gauges and meters

Speedometer

Type A



Type B



The speedometer indicates the speed of the vehicle and is calibrated in miles per hour (MPH) or kilometers per hour (km/h).

Tachometer

Type A



Type B



The tachometer indicates the approximate number of engine revolutions per minute (RPM).

Use the tachometer to select the correct shift points and to prevent lugging and/or over-revving the engine.

NOTICE

Do not operate the engine within the tachometer's RED ZONE to prevent severe engine damage.

Engine coolant temperature gauge

Type A



Type B



The engine coolant temperature gauge indicates the temperature of the engine coolant when the ignition switch is in the ON position.

NOTICE

If the gauge pointer moves beyond the normal range area toward the "H" position, it indicates the engine coolant is overheating.

Do not continue driving with an overheated engine. If your engine overheats, refer to the "If the engine overheats" section in chapter 8.

⚠ WARNING

Never remove the radiator cap or engine coolant reservoir cap when the engine is hot. The engine coolant is under pressure and may cause burn or injury. Always use a rag.

Fuel gauge

Type A



Type B



The fuel gauge indicates the approximate amount of fuel remaining in the fuel tank.

i Information

- The fuel tank capacity is given in chapter 10.
- The fuel gauge is supplemented by a low fuel warning light, that illuminates when the fuel tank is nearly empty.
- On inclines or curves, the fuel gauge pointer may fluctuate or the low fuel warning light may come on earlier than usual due to the movement of fuel in the tank.

⚠ CAUTION

If the shift gear is not P (Park) or N (Neutral) during refueling, the refueling may not be recognized and the fuel amount and distance to empty may be displayed abnormally.

⚠ WARNING

Always refuel the vehicle as soon as possible after the warning light comes on or when the gauge indicator comes close to E (Empty) level.

NOTICE

Avoid driving with an extremely low fuel level. Running out of fuel may cause the engine to misfire and cause damage to the catalytic converter.

Outside temperature gauge

Type A



Type B

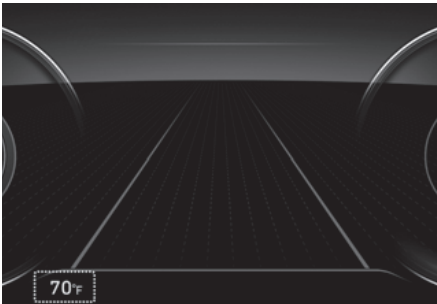

The outside ambient temperature appears in the lower portion of the cluster display. The temperature reads in Fahrenheit or Celsius depending on the units selected from the Settings menu in the instrument cluster or infotainment system.

The temperature indicated on the instrument cluster may not change as quickly as the outside temperature.

Select:

- **User Settings > Units > Temperature Unit > °F/°C** (for cluster type)
- **Setup > General > Units > Temperature Unit > °F/°C** (for infotainment system type)

Both the temperature unit on the instrument cluster and climate control information screen is changed.

Odometer

Type A

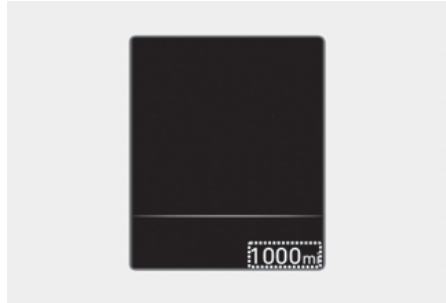

Type B

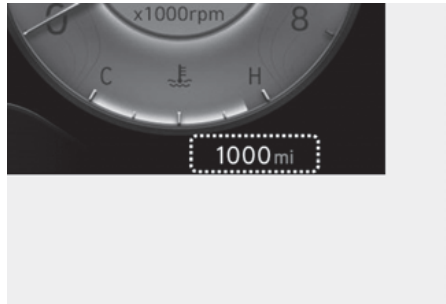

The odometer indicates the total distance that the vehicle has been driven and is used to determine when periodic maintenance is required.

Range

Type A



Type B

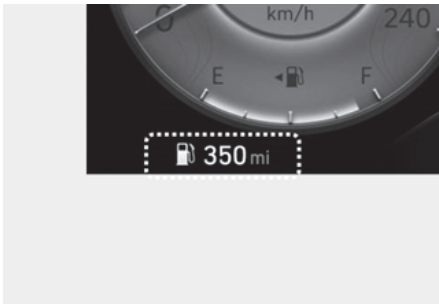

- The range is the estimated distance the vehicle can be driven with the remaining fuel.
- If the estimated distance is below 1 mi. (1 km), the trip computer displays "----" as range. When this occurs, refuel the vehicle immediately.

i Information

- The range may differ from the actual driving distance because it is only an estimate as it is an estimate of the available driving distance.
- The range may differ significantly based on driving conditions, driving habits, and condition of the vehicle.
- If the vehicle is not on level ground or the battery power has been interrupted, the distance to empty function may not operate correctly.
- The distance to empty indicator may not change accurately if less than 1.5 gallons (6 liters) of fuel are added to the vehicle.

Transmission shift indicator

Type A

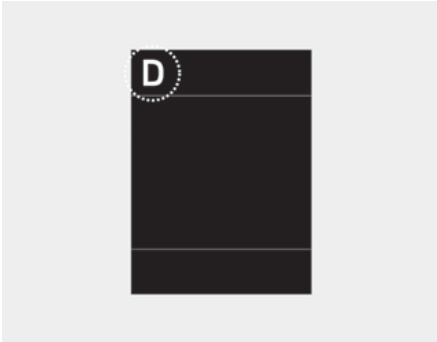

Type B

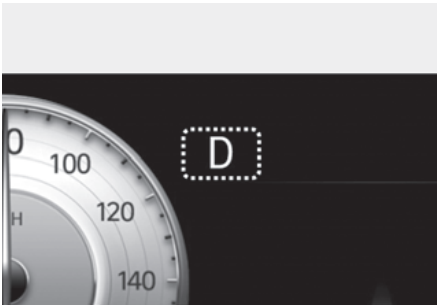

The transmission shift indicator in the upper corner of the cluster display indicates the current gear or P (Park).

Warning and indicator lights

i Information

Make sure that all warning lights are OFF after starting the engine. If any light is still ON, this indicates a situation that needs attention.

Airbag warning light



This warning light illuminates:

- When the ignition switch is in the ON position. It illuminates for 3-6 seconds and then goes off.
- When there is a malfunction with the SRS.

If the Airbag warning light remains illuminated while driving, have the vehicle inspected by an authorized HYUNDAI dealer.

Seat belt warning light



This warning light informs the driver that the seat belt is not fastened.

For more information, refer to the "Seat belts" section in chapter 3.

Parking brake & brake fluid warning light



This warning light illuminates:

- When the ignition switch is in the ON position. It illuminates for about 3 seconds and then goes off once the parking brake is released.
- Whenever the parking brake is applied.
- Whenever the brake fluid level in the reservoir is low.
 - If the warning light illuminates with the parking brake released, it indicates that the brake fluid level in the reservoir is low.

If the brake fluid level in the reservoir is low:

1. Drive carefully to the nearest safe location and stop your vehicle.
2. With the engine stopped, check the brake fluid level immediately and add fluid as required. For more information, refer to the "Brake fluid" section in chapter 9. After adding brake fluid, check all brake components for fluid leaks. If a brake fluid leak is found, or if the warning light remains on, or if the brakes do not operate properly, do not drive the vehicle. Have the vehicle inspected by an authorized HYUNDAI dealer.

Dual-diagonal braking system

Your vehicle is equipped with the dual-diagonal braking systems. This means you still have braking on two wheels even if one of the dual systems fails.

With only one of the dual systems working, more than normal pedal travel and greater pedal force are required to stop the vehicle.

Also, the vehicle does not stop in a short distance if only a portion of the braking system is working.

If you experience a malfunction with the braking system while driving, attempt to slow your vehicle by coasting or by using engine braking. You may be able to reduce your vehicle speed by manually downshifting to a lower gear. Use manual shift mode using either the shift lever (if equipped) or the paddle shifters (if equipped) to shift to a lower gear.

! WARNING

If the Parking Brake warning light illuminates with the parking brake released, it indicates that the brake fluid level is low. Have the vehicle inspected by an authorized HYUNDAI dealer.

Anti-lock Brake System (ABS) warning light



This warning light illuminates:

- When the ignition switch is in the ON position. It illuminates for about 3 seconds and then goes off.
- Whenever there is a malfunction with the ABS.

The hydraulic braking system still operates even if there is a malfunction with the ABS.

If the ABS warning light remains illuminated while driving, have the vehicle inspected by an authorized HYUNDAI dealer.

Electronic Brake Force Distribution (EBD) system warning light



When the ABS warning and Parking Brake warning lights are on simultaneously, it may indicate a problem with the Electronic Brake Force Distribution system.

If both the ABS warning light and the Parking Brake warning light remain illuminated while driving, have the vehicle inspected by an authorized HYUNDAI dealer.

WARNING

When both ABS and Parking Brake warning lights are on, the braking system does not work normally and you may experience an unexpected and dangerous situation during sudden braking.

Avoid high speed driving and abrupt braking.

Have the vehicle inspected by an authorized HYUNDAI dealer as soon as possible.

Information

When the ABS warning light is on or both ABS and Parking Brake warning lights are on, the speedometer, odometer, or tripmeter may not work. Also, the MDPS warning light may illuminate and the steering effort may increase or decrease.

Electronic Parking Brake (EPB) warning light

 if equipped

EPB

This warning light illuminates:

- When the ignition switch is in the ON position. It illuminates for about 3 seconds and then goes off.
- Whenever there is a malfunction with the EPB.

If the EPB warning light remains illuminated while driving, have the vehicle inspected by an authorized HYUNDAI dealer

Information

The Electronic Parking Brake (EPB) warning light may illuminate when the Electronic Stability Control (ESC) indicator light comes on to indicate that ESC is not working properly. This does not indicate malfunction of EPB.

AUTO HOLD indicator light

 if equipped

AUTO HOLD

This indicator light illuminates:

- White: When you activate Auto Hold by pressing the AUTO HOLD switch.
- Green: When you stop the vehicle completely by depressing the brake pedal with Auto Hold activated.
- Yellow: Whenever a malfunction with the Auto Hold is detected.

If the AUTO HOLD indicator light remains yellow while driving, have the vehicle inspected by an authorized HYUNDAI dealer.

For more information, refer to the "Electronic Parking Brake (EPB)" section in chapter 6.

Motor Driven Power Steering (MDPS) warning light



This warning light illuminates:

- When the ignition switch is in the ON position. It illuminates for about 3 seconds and then goes off.
- Whenever there is a malfunction with the Motor Driven Power Steering.

If the MDPS warning light remains illuminated while driving, have the vehicle inspected by an authorized HYUNDAI dealer.

Malfunction Indicator Lamp (MIL)



This warning light illuminates:

- When the ignition switch is in the ON position. It illuminates for about 3 seconds and then goes off.
- Whenever there is a malfunction with either the emission control system or the engine or the vehicle powertrain.

If the MIL warning light remains illuminated while driving, have the vehicle inspected by an authorized HYUNDAI dealer.

- If the enhanced engine protection system activates due to the lack of engine oil, the engine power is limited.

NOTICE

- Driving with the Malfunction Indicator Lamp (MIL) on may cause damage to the emission control system that may affect drivability and/or fuel economy.
- If the Malfunction Indicator Lamp (MIL) illuminates, catalytic converter damage is possible that may result in loss of engine power.

Charging system warning light



When there is a malfunction with either the alternator or electrical charging system.

If there is a malfunction with either the alternator or electrical charging system:

1. Drive carefully to the nearest safe location and stop your vehicle.
2. Turn the engine OFF and check the alternator drive belt for looseness or breakage.

If the belt is adjusted properly, there may be a problem in the electrical charging system.

If the Charging system warning light remains illuminated while driving, have the vehicle inspected by an authorized HYUNDAI dealer.

Engine oil level warning light

 if equipped



This warning light illuminates:

When the engine oil level is low. Check the engine oil level as soon as possible and add engine oil as required.

Use only the specified engine oil. Refer to the "Recommended lubricants and capacities" section in chapter 10.

Do not overfill the engine oil. Make sure the oil level is not above F (Full) mark on the dipstick.

i Information

- If you travel approximately 30-60 mi. (50-100 km) after the engine warms up, after adding the engine oil, the warning light will go off.
- Cycle the ignition from OFF to ON 3 times within 10 seconds, the warning light will go off immediately. However, when you turn off the warning light without adding the engine oil, the light will come on again after traveling approximately 30-60 mi. (50-100 km) after the engine warms up.

NOTICE

If the warning light comes on continuously after adding the engine oil and travelling approximately 30-60 mi. (50-100 km) after the engine warms up, have the system inspected by an authorized HYUNDAI dealer.

Even if this light doesn't come on after the engine has started, the engine oil level should be periodically checked and topped up if required.

Engine oil pressure warning light



This warning light illuminates:

When the engine oil pressure is low.

If the engine oil pressure is low:

1. Drive carefully to the nearest safe location and stop your vehicle.
2. Turn the engine off and check the engine oil level (For more information, refer to the "Engine oil" section chapter 9). If the level is low, add oil as required.

If the warning light remains on after adding oil or if oil is not available, have the vehicle inspected by an authorized HYUNDAI dealer.

i Information

When engine oil pressure decreases due to insufficient engine oil, etc., the Engine Oil Pressure warning light illuminates. In addition, the enhanced engine protection system that limits engine power is activated.

When the engine oil pressure is restored, the warning light and the enhanced engine protection system will turn off after the engine is restarted.

NOTICE

- Continued driving with the warning light on may cause engine failure.
- If the engine is not turned OFF immediately after the Engine Oil Pressure warning light is illuminated, severe damage could occur.

Low fuel level warning light



This warning light illuminates:

When the fuel tank is nearly empty. Refuel the vehicle as soon as possible.

NOTICE

Driving with the Low Fuel Level warning light on or with the fuel level below "E" may cause the engine to misfire and damage the catalytic converter.

Master warning light



This warning light illuminates:

If a malfunction is detected in any of the following:

- Forward Collision-Avoidance Assist malfunction
- Forward Collision-Avoidance Assist radar blocked (if equipped)
- Blind-Spot Collision-Avoidance Assist malfunction (if equipped)
- Blind-Spot Collision-Avoidance Assist radar blocked (if equipped)
- High Beam Assist malfunction (if equipped)
- Lamp malfunction (if equipped)
- Smart Cruise Control malfunction (if equipped)
- Tire Pressure Monitoring System (TPMS) malfunction (if equipped)

If the issue is resolved, the Master warning light turns off.

Low tire pressure warning light

if equipped



This warning light illuminates:

- When the ignition switch is in the ON position. It illuminates for about 3 seconds and then goes off.
- When one or more tires are significantly underinflated. (The location of the under-inflated tire appears on the cluster display.)

For more information, refer to the "Tire Pressure Monitoring System (TPMS)" section in chapter 8.

This warning light remains ON after blinking for about 60 seconds, or repeatedly blinks ON and OFF at 3 second intervals:

When there is a malfunction with the TPMS.

In this occurs, have the vehicle inspected by an authorized HYUNDAI dealer as soon as possible.

For more information, refer to the "Tire Pressure Monitoring System (TPMS)" in section chapter 8.

WARNING

- The TPMS cannot alert you to severe and sudden tire damage caused by external factors.
- If you notice any vehicle instability, immediately take your foot off the accelerator pedal, apply the brakes gradually with light force, and slowly move to a safe position off the road.

Electronic Stability Control (ESC) indicator light



This indicator light illuminates:

- When the ignition switch is in the ON position. It illuminates for about 3 seconds and then goes off.
- Whenever there is a malfunction with the ESC system.

If this occurs, have the vehicle inspected by an authorized HYUNDAI dealer.

This indicator light blinks:

While the ESC is operating.

For more information, refer to the "Electronic Stability Control (ESC)" section in chapter 6.

Electronic Stability Control (ESC) OFF indicator light



This indicator light illuminates:

- When the ignition switch is in the ON position. It illuminates for about 3 seconds and then goes off.
- When you deactivate the ESC system by pressing the ESC OFF button.

For more information, refer to the "Electronic Stability Control (ESC)" section in chapter 6.

AUTO STOP indicator light

 If equipped



This indicator light illuminates:

When the engine enters the Idle Stop mode of ISG (Idle Stop and Go) system.

When the engine automatically starts, the AUTO STOP indicator on the cluster illuminates to white.

For more information, refer to the "Idle Stop and Go (ISG) system" section in chapter 6.

i Information

When the ISG system automatically starts the engine, some warning lights (ABS, ESC, ESC OFF, MDPS or Parking brake warning light) may turn on for a few seconds because of a low battery voltage but not a system malfunction.

Immobilizer indicator light (without smart key)



This indicator light illuminates:

When the vehicle detects the immobilizer in the key with the ignition switch in the ON position.

- At this time, you can start the engine.
- The indicator light goes off after starting the engine.

This indicator light blinks:

Whenever there is a malfunction with the immobilizer system.

If this occurs, have the vehicle inspected by an authorized HYUNDAI dealer.

Immobilizer indicator light (with smart key)

 if equipped



This indicator light illuminates for up to 30 seconds:

When the vehicle detects the smart key in the vehicle with the Button Start ignition switch in the ACC or ON position.

- At this time, you can start the engine.
- The indicator light goes off after starting the engine.

This indicator light blinks for a few seconds:

When the smart key is not in the vehicle, you cannot start the engine.

This indicator light illuminates for 2 seconds and goes off:

If the smart key is in the vehicle and the Button Start ignition switch is ON, but the vehicle cannot detect the smart key.

If this occurs, have the vehicle inspected by an authorized HYUNDAI dealer.

This indicator light blinks:

Whenever there is a malfunction with the immobilizer system.

If this occurs, have the vehicle inspected by an authorized HYUNDAI dealer.

Turn signal indicator light



This indicator light blinks:

When you operate the turn signal lever.

If any of the following occur, there may be a malfunction with the turn signal system.

- The turn signal indicator light illuminates but does not blink.
- The turn signal indicator light blinks rapidly.
- The turn signal indicator light does not illuminate at all.

If any of these occur, have your vehicle inspected by an authorized HYUNDAI dealer.

Exterior light warning light

 if equipped



This warning light illuminates:

When one of the exterior bulbs (headlight, DRL, turn signal light, stop light, etc) is not operating properly. Replace the burned out bulb with a new one with the same wattage rating.

LED headlight warning light

 if equipped



This warning light illuminates:

- When the ignition switch is in the ON position. It illuminates for about 3 seconds and then goes off.
- Whenever there is a malfunction with a LED headlight.

If the LED Headlight warning light remains illuminated while driving, have the vehicle inspected by an authorized HYUNDAI dealer.

This warning light blinks:

Whenever there is a malfunction with a LED headlight related part.

If this occurs, have the vehicle inspected by an authorized HYUNDAI dealer.

NOTICE

Driving with the LED Headlight warning light on or blinking may reduce LED headlight life.

High beam indicator light



This indicator light illuminates:

- When the headlights are on and the turn signal lever is moved to the high beam position.
- When the turn signal lever is pulled into the Flash-to-Pass position.

Light ON indicator light



This indicator light illuminates:

When the tail lights or headlights are on.

High Beam Assist indicator light

 if equipped



This indicator light illuminates:

When the high beam is on with the light switch in the AUTO light position.

- White: When High Beam Assist is ready to operate.
- Green: When High Beam Assist is operating.

If your vehicle detects oncoming or preceding vehicles, High Beam Assist system switches the high beam to low beam automatically.

For more information, refer to the "High Beam Assist (HBA)" section in chapter 5.

Forward Safety warning light

 if equipped



This warning light illuminates:

- When the ignition switch is in the ON position. It illuminates for about 3 seconds and then goes off.
- Yellow: When Forward Safety of Forward Collision-Avoidance Assist is deselected, disabled, or a malfunction is detected.

If the yellow warning light remains on after the sensor has been uncovered or unblocked when Forward Safety is set, we recommend that your vehicle be inspected by an authorized HYUNDAI dealer.

This warning light blinks:

- Red: When Forward Safety function is operating.

For more information, refer to the "Forward Collision Avoidance Assist (FCA) (Front view camera only)" section in chapter 7.

Lane Safety indicator light

 if equipped



This warning light illuminates:

- When the ignition switch is in the ON position. It illuminates for about 3 seconds and then goes off.
- Yellow: When Driver Attention Warning is disabled or a malfunction is detected.

If the yellow indicator light remains on after the front view camera has been uncovered or unblocked, we recommend that your vehicle be inspected by an authorized HYUNDAI dealer.

This warning light blinks:

- Yellow: Driver Attention Warning recommends to take a break.

For more information, refer to the "Lane Keeping Assist (LKA)" section in chapter 7.

Driver Attention Warning light



This indicator light illuminates:

- When the ignition switch is in the ON position. It illuminates for about 3 seconds and then goes off.
- Yellow: When Driver Attention Warning is disabled or a malfunction is detected.

If the yellow indicator light remains on after the front view camera has been uncovered or unblocked, have your vehicle inspected by an authorized HYUNDAI dealer.

This indicator light blinks:

- Yellow: Driver Attention Warning recommends to take a break.

For more information, refer to the "Driver Attention Warning (DAW)" section in chapter 7.

Cruise indicator light

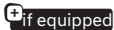

This indicator light illuminates:

When the cruise control system is enabled.

For more information, refer to the "Cruise Control (CC)" section in chapter 7.

SPORT mode indicator light



This indicator light illuminates:

When you select "SPORT" mode as drive mode.

For more information, refer to the "Drive mode integrated control system" section in chapter 6.

SMART mode indicator light

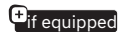

This indicator light illuminates:

When you select "SMART" mode as drive mode.

For more information, refer to the "Drive mode integrated control system" section in chapter 6.

Icy road warning light



This indicator light illuminates:

To warn the driver the road may be icy.

When the outside temperature on the temperature gauge is below 40 °F (4 °C), a single chime sounds, both the outside temperature gauge and Icy Road Warning indicator blink several times, and then they remain illuminated.

You can activate or deactivate the Icy Road Warning function from the Settings menu in the instrument cluster.

i Information

If the Icy Road warning light appears while driving, avoid speeding, rapid acceleration, sudden braking, or sharp turning.

Cluster display messages

Shift to P (with smart key)

+if equipped

This message appears if the Push Button Start ignition switch is pressed to the OFF position without the gear in the P (Park) position.

If this occurs, the Push Button Start ignition switch goes to the ACC position.

Low key battery (with smart key)

+if equipped

When the Push Button Start ignition switch is pressed to the OFF position, a message may appear, indicating the internal battery of the Smart Key is low. Replace the Smart Key battery.

Press brake pedal to start engine (with smart key)

+if equipped

This message appears if the Push Button Start ignition switch is pressed repeatedly without depressing the brake pedal.

Start the vehicle by depressing the brake pedal and then pressing the Push Button Start ignition switch.

Key not in vehicle (with smart key)

+if equipped

This warning message is displayed if the smart key is not in the vehicle when you press the Engine Start/Stop button.

When attempting to start the vehicle, always have the smart key with you.

Key not detected (with smart key)

+if equipped

This message appears if the smart key is not detected when you press the Push Button Start ignition switch.

Press START button again (with smart key)

+if equipped

If you cannot start the vehicle after the Push Button Start ignition switch is pressed, attempt to start the engine by pressing the Push Button Start ignition switch again.

If the warning message appears each time you press the Push Button Start ignition switch, have the vehicle inspected by an authorized HYUNDAI dealer.

Press START button with key (with smart key)

+if equipped

This message appears and the immobilizer indicator blinks if you press the Push Button Start ignition switch while the warning message, "Key not detected" appears.

Check BRAKE SWITCH fuse (with smart key)

+if equipped

This message appears if the brake switch fuse is disconnected.

Replace the fuse before starting the engine.

If that is not possible, start the engine by pressing the Engine Start/ Stop button for 10 seconds in the ACC position.

Shift to P or N to start engine (with smart key)

 if equipped

This message appears if you try to start the engine in any other position except P (Park) or N (Neutral).

i Information

You can start the engine with the gear in N (Neutral). But, for your safety, always start the engine with the vehicle in P (Park) with your foot depressing the brake pedal.

Battery discharging due to external electrical devices

 if equipped

This message appears if the vehicle battery voltage is low or if a current draw is detected that could drain the vehicle battery.

Do not connect any external electronic devices to the battery system or battery discharge may occur.

If this message appears on the cluster and there are no other external electronic devices connected to the vehicle, have the vehicle inspected by an authorized HYUNDAI dealer.

Door, Hood, Trunk open indicator

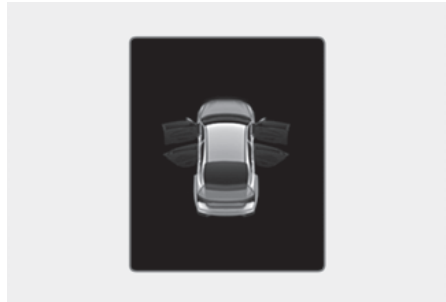

This warning appears if any door or hood or trunk is left open. The warning indicates which door is open on the cluster display.

! WARNING

Before driving the vehicle, confirm the door, hood, and trunk are fully closed. Also, check there are no door, hood, and trunk open warning lights or messages displayed on the instrument cluster.

Sunroof open indicator

 if equipped

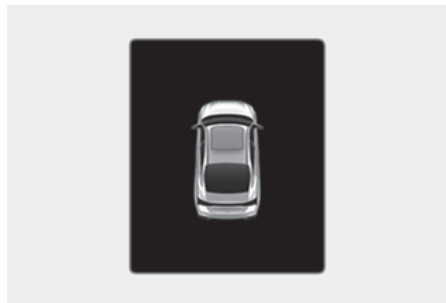

This warning appears if you turn off the engine when the sunroof is open. Close the sunroof securely before leaving your vehicle.

Low tire pressure



This warning message appears if the tire pressure is low. The corresponding tire on the vehicle illuminates.

For more information, refer to the "Tire Pressure Monitoring System (TPMS)" section in chapter 8.

Lights

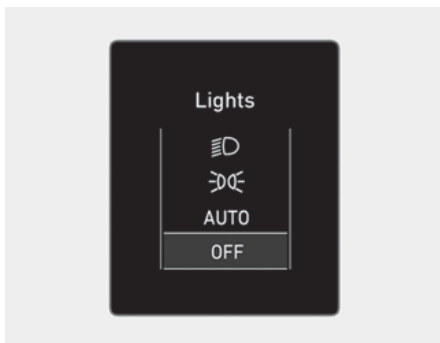

This indicator displays which exterior light is selected using the lighting control.

Wiper

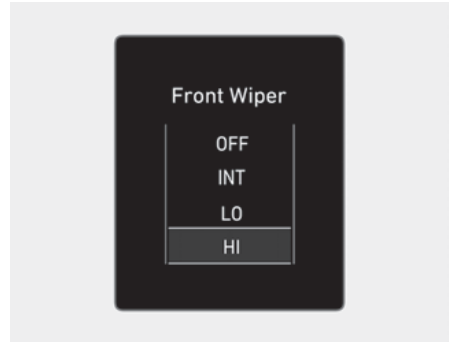

This indicator displays which wiper speed is selected using the wiper control.

Low fuel

This message appears if the fuel tank is almost out of fuel.

When this message appears, the low fuel level warning light on the cluster comes on.

Refuel as soon as possible.

Engine overheated

 if equipped

This message appears when the engine coolant temperature is above 248 °F (120 °C). The engine is overheated and may be damaged.

If your vehicle is overheated, refer to the "If the engine overheats" section in chapter 8.

Check headlight

 if equipped

This message appears if the headlights are not operating properly. Replace the burned out bulb with a new one with the same wattage rating.

Check headlight (Low)

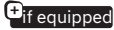
 if equipped

This message appears if the headlights (Low) are not operating properly. Replace the burned out bulb with a new one with the same wattage rating.

Check turn signal

 if equipped

This message appears if the turn signal light is not operating properly.

Replace the burned out bulb with a new one with the same wattage rating.

Check brake light

 if equipped

This message appears if the brake light is not operating properly.

Replace the burned out bulb with a new one with the same wattage rating.

Check daytime running light

 if equipped

This message appears if the daytime running light is not operating properly.

Replace the burned out bulb with a new one with the same wattage rating.

Check high mounted stop light

 if equipped

This message appears if the high mounted stop light is not operating properly.

Replace the burned out bulb with a new one with the same wattage rating.

Check headlight LED



 if equipped

This message appears if there is a problem with the LED headlight. Have the vehicle inspected by an authorized HYUNDAI dealer.

Cluster display (Type A)

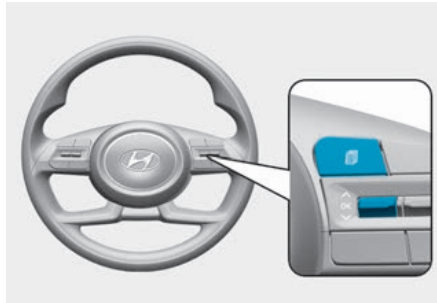
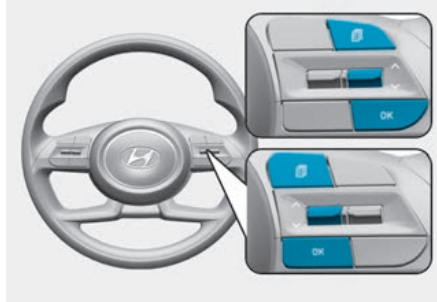
Cluster display control







| Switch | Function |
|---|---|
|  | MODE button for changing modes. |
|  | MOVE switch for changing items. |
| OK | SELECT/RESET button for setting or resetting the selected item. |

i Information

If equipped with an infotainment system, only the Settings menu in the infotainment system is supported and not the instrument cluster.

Cluster display modes

| Modes | Symbol | Explanation |
|--------------------|---|--|
| Trip Computer |  | This mode displays driving information such as the tripmeter, fuel economy, etc. |
| Turn By Turn (TBT) |  | This mode displays the navigation guidance. |
| Driving Assist |  | This mode displays: <ul style="list-style-type: none"> • Smart Cruise Control (if equipped) • Lane Keeping Assist • Lane Following Assist |
| User Settings |  | In this mode, you can change settings of the doors, lights, etc. |
| Warning |  | <ul style="list-style-type: none"> • The Master Warning mode displays warning messages related to the vehicle when one or more systems are not operating normally. • Tire pressure information is displayed. |

The information provided may differ depending on which functions are available to your vehicle.

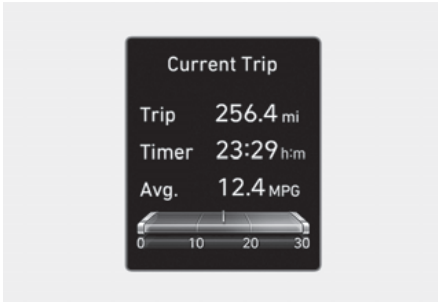
Trip computer group

The trip computer mode displays information related to vehicle driving parameters including fuel economy, trip meter information, and vehicle speed. For more information, refer to the "Trip computer" section in this chapter.

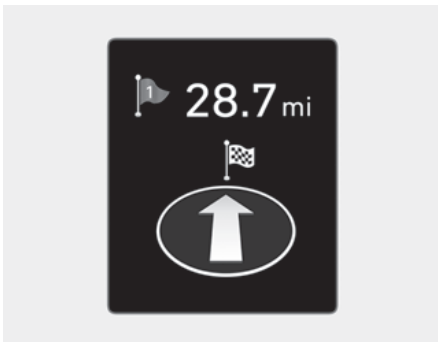
Turn By Turn (TBT) group

Turn-by-turn navigation and distance/time to destination appear when Turn by Turn mode is selected.

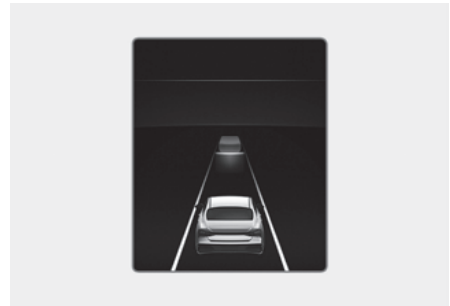
Driving Assist group**LKA/SCC**

Displays the state of Smart Cruise Control (if equipped) and Lane Keeping Assist. For more information, refer to the each function information in chapter 7.

Master warning group

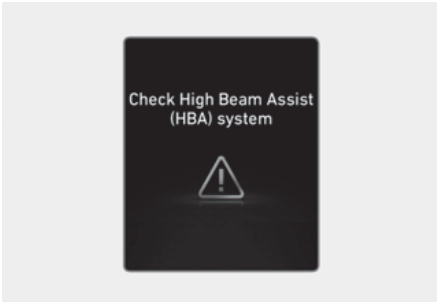

The Master Warning Light illuminates if one or more of the following occurs:

- Forward Collision-Avoidance Assist system malfunction
- Forward Collision-Avoidance Assist radar blocked (if equipped)
- Blind-Spot Collision-Avoidance Assist malfunction (if equipped)
- Blind-Spot Collision-Avoidance Assist radar blocked (if equipped)
- High Beam Assist malfunction
- Lamp malfunction (if equipped)
- Smart Cruise Control malfunction (if equipped)
- Tire Pressure Monitoring System (TPMS) malfunction (if equipped)

If the issue is resolved, the Master Warning Light and the Master Warning icon are turned off.

Tire Pressure



For more information, refer to the "Tire Pressure Monitoring System (TPMS)" section in chapter 8.

User settings mode

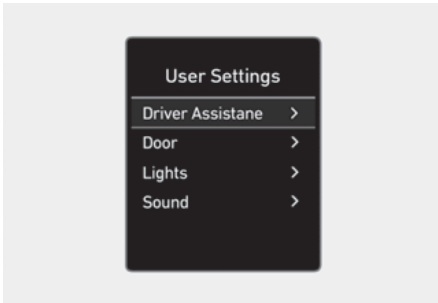

In this mode, you can change the settings of the instrument cluster, doors, lamps, etc.

1. Driver Assistance
2. Door
3. Lights
4. Sound
5. Convenience
6. Service interval
7. Theme selection
8. Other
9. Language
10. Reset

These options may differ depending on which functions are available on your vehicle.

Shift to P to edit settings/Engage parking brake to edit settings

This warning message appears if you try to select an item from the User Settings mode while driving.

Change the settings after parking the vehicle, applying the parking brake, and shifting the gear to P (Park).

Quick guide (Help)

This mode provides quick guides for the systems in the User Settings mode.

Select an item, press and hold the OK button.

For more information about each system, refer to this Owner's Manual.

1. Driver Assistance

| Items | Explanation |
|--------------------------|--|
| Driving Convenience | <ul style="list-style-type: none"> • Smart Cruise Control To set the Distance, Acceleration, Reaction Speed of Smart Cruise Control. For more information, refer to the "Smart Cruise Control (SCC)" section in chapter 7. |
| Speed limit | To adjust Speed Limit Assist <ul style="list-style-type: none"> • Speed Limit Offset • Speed Limit Assist/Speed Limit Warning/Off For more information, refer to the "Intelligent Speed Limit Assist (ISLA)" section in chapter 7. |
| Warning Methods | To adjust the warning methods of the driver assistance system. <ul style="list-style-type: none"> • Warning Volume: High/Medium/Low/Off • Haptic Warning |
| Driver Attention Warning | <ul style="list-style-type: none"> • Leading Vehicle Departure Alert To activate or deactivate the Leading vehicle departure alert. For more information, refer to the "Driver Attention Warning (DAW)" section in chapter 7. |
| Driving Safety | <ul style="list-style-type: none"> • Forward Safety <ul style="list-style-type: none"> To activate or deactivate the Forward Safety. • Forward Safety Warning Timing <ul style="list-style-type: none"> To adjust the Forward Safety warning timing of the driver assistance system. For more information, refer to the "Forward Collision Avoidance Assist (FCA) (Sensor fusion)" section in chapter 7 • Lane Safety <ul style="list-style-type: none"> To activate or deactivate the Lane Safety. For more information, refer to the "Lane Keeping Assist (LKA)" section in chapter 7 • Blind-Spot Safety <ul style="list-style-type: none"> To activate or deactivate the Blind-Spot Safety. For more information, refer to the "Blind-spot Collision-Avoidance Assist (BCA)" section in chapter 7 • Exit Safety <ul style="list-style-type: none"> To activate or deactivate the Exit Safety. For more information, refer to the "Safe Exit Warning (SEW)" section in chapter 7 |

| Items | Explanation |
|----------------|--|
| Parking Safety | <ul style="list-style-type: none"> <li data-bbox="303 224 1065 331">• Parking Distance Warning Auto ON To activate or deactivate Parking Distance Warning Auto On. For more information, refer to the "Forward/Reverse Parking Distance Warning (PDW)" section in chapter 7. <li data-bbox="303 337 1065 443">• Rear Cross-Traffic Safety To activate or deactivate Rear Cross-Traffic Safety. For more information, refer to the "Rear Cross-traffic Collision-Avoidance Assist (RCCA)" section in chapter 7. |

* The information provided may differ depending on which functions are applicable to your vehicle.

2. Door

| Items | Explanation |
|------------------|--|
| Auto Lock | <ul style="list-style-type: none"> • Enable on Shift: All doors will be automatically locked if the shift lever is moved from the P (Park) position to the R (Reverse), N (Neutral), or D (Drive) position. (Only when the engine is running) • Enable on Speed: All doors will be automatically locked when the vehicle speed exceeds 9.3 mph (15 km/h) • Disable : The auto door lock operation will be deactivated. |
| Auto Unlock | <ul style="list-style-type: none"> • On Shift to P: All doors will be automatically unlocked if the shift lever is moved to P (Park) position. (Only when the engine is running) • On key out/Vehicle Off : All doors will be automatically unlocked when the ignition key is removed from the ignition switch or the Engine Start/Stop button is set to the OFF position. • Disable : The auto door unlock operation will be canceled. |
| Two Press Unlock | <ul style="list-style-type: none"> • Off: The two press unlock function will be deactivated. Therefore, all doors will unlock if the door unlock button is pressed. • On: Only the driver's door will unlock if the door unlock button is pressed. When the door unlock button is pressed again within 4 seconds, the remaining doors will unlock. |
| Horn Feedback | <p>To activate or deactivate the horn feedback. If the horn feedback is activated, after locking the door by pressing the lock button on the remote key, and pressing it again within 4 seconds, the horn feedback sound will operate once to indicate that all doors are locked (if equipped with remote key).</p> |
| Smart Trunk | <p>To activate or deactivate the smart trunk. For more information, refer to the "Smart Trunk release" section in chapter 5.</p> |

3. Lights

| Items | Explanation |
|-----------------------|--|
| Illumination | To adjust the illumination level. <ul style="list-style-type: none"> • Level 1-20 |
| One Touch Turn Signal | <ul style="list-style-type: none"> • Off: The one touch turn signal function will be deactivated. • 3, 5, 7 Flashes: The turn signal indicator will blink 3, 5, or 7 times when the turn signal lever is moved slightly. For more information, refer to the "Lighting control" section in chapter 5. |
| Headlight Delay | <ul style="list-style-type: none"> • To activate or deactivate the headlight delay function. For more information, refer to the "Lighting control" section in chapter 5. |
| High Beam Assist | <ul style="list-style-type: none"> • To activate or deactivate the High Beam Assist function. For more information, refer to the "High Beam Assist (HBA)" section in chapter 5. |

4. Sound

| Items | Explanation |
|-------------------------------|--|
| Cluster Voice Guidance Volume | To adjust the cluster voice guidance volume. |
| Welcome sound | To activate or deactivate the welcome sound. |

5. Convenience

| Items | Explanation |
|--------------------------|---|
| Rear Occupant Alert | <ul style="list-style-type: none"> To activate or deactivate the rear occupant alert system. For more information, refer to the "Rear Occupant Alert (ROA)" section in chapter 5. |
| Welcome Light | <ul style="list-style-type: none"> On door unlock: The welcome light turns on automatically when the doors are unlocked. On driver approach: The welcome light turns on automatically when the vehicle is approached with the smart key. For more information, refer to the "Mood lamp" section in chapter 5. |
| Wireless Charging System | <p>To activate or deactivate the wireless charging system in the front seat. For more information, refer to the "Wireless smartphone charging system" section in chapter 5.</p> |
| Wiper/Lights Display | <p>To activate or deactivate the Wiper/Light mode. When activated, the cluster display shows the selected Wiper/Light mode whenever you changed the mode.</p> |
| Icy Road Warning | <p>To activate or deactivate the icy road warning function.</p> |

6. Service interval

| Items | Explanation |
|-------------------------|--|
| Enable Service Interval | To activate or deactivate the service interval function. |

i Information

To use the service interval menu, contact an authorized HYUNDAI dealer.

If the service interval is activated and the time and distance is adjusted, messages are displayed in the following situations each time the vehicle is turned on.

- Service in
: Displayed to inform the driver the remaining mileage and days to service.
- Service required
: Displayed when the mileage and days to service has been reached or passed.

i Information

If any of the following conditions occur, the mileage and number of days to service may be incorrect.

- The battery cable is disconnected.
- The fuse switch is turned off.
- The battery is discharged.

7. Theme selection

| Items | Explanation |
|---------|--|
| Theme A | To select the style of instrument cluster graphic style and setting. |
| Theme B | |
| Theme C | |

8. Other

| Items | Explanation |
|--------------------------|---|
| Fuel Econ. Reset | <ul style="list-style-type: none"> Off: The average fuel economy will not reset automatically whenever refueling. After ignition: When the engine has been OFF for 4 hours or longer the average fuel economy will reset automatically. After refueling: The average fuel economy will reset automatically after adding 6 liters (1.6 gallons) of fuel or more and after driving speed exceeds 1 mph (1 km/h). For more information, refer to the "Trip computer" section in this chapter. |
| Speed Unit (if equipped) | To select the speed unit. (km/h, MPH) |
| Fuel Econ. Unit | To select the fuel economy unit. (km/L, L/100km, MPG) |
| Temperature Unit | To select the temperature unit. (°C, °F) |
| Tire Pressure Unit | To select the tire pressure unit. (psi, kPa, bar) |

9. Language

 if equipped

| Items | Explanation |
|----------|--|
| Language | Choose the language. You can choose the language in infotainment system. (if equipped) |

10. Reset

| Items | Explanation |
|-------|---|
| Reset | You can reset the menus in the User Settings Mode. All menus in the User Settings Mode are reset to factory settings, except language and service interval. |

Trip computer

i Information

Some driving information stored in the trip computer resets if the battery is disconnected.

Current Trip

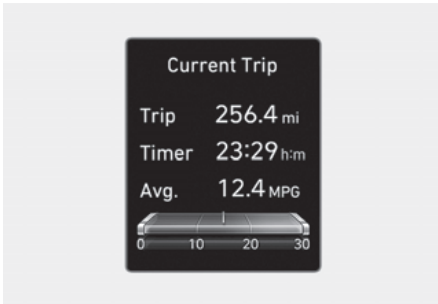

The trip computer mode displays information related to vehicle driving parameters including fuel economy, tripmeter information, and vehicle speed.

Since Refueling



After the vehicle has been refueled, the trip distance, total driving time and average fuel economy appear.

To reset manually, press the **OK** button on the steering wheel for more than 1 second when "**Since Refueling**" appears.

Since Reset

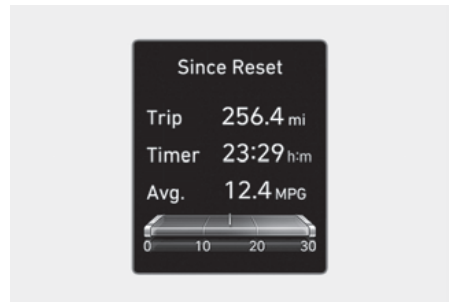

Accumulated trip distance, total driving time, and average fuel economy appear.

The information is accumulated starting from the last reset.

To reset manually, press the **OK** button on the steering wheel for more than 1 second when "**Since Reset**" appears.

Digital speedometer

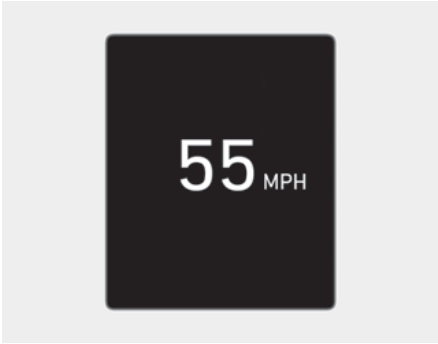

Displays the speed of the vehicle.

Auto Stop accumulated time

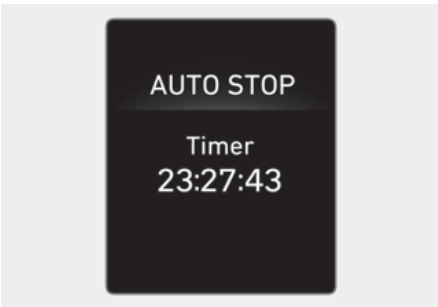



Displays the elapsed time of engine stop by the Idle Stop and Go system.

For more information, refer to the "Idle Stop and Go (ISG) system" section in chapter 6.

Cluster display (Type B)

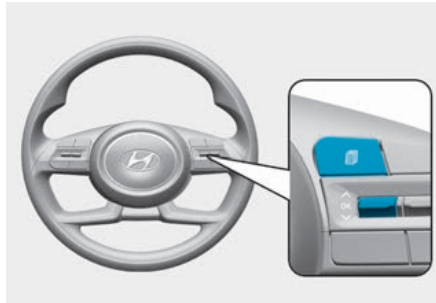
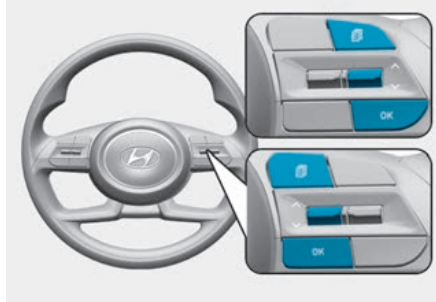
Cluster display control



| Switch | Operation | Function |
|---|--------------|---|
|  | Tap | MODE button for changing view modes. |
|  | Tap | MOVE switch for changing items. |
| OK | Tap | SELECT/RESET button for setting the selected item. |
| | Tap and hold | SELECT/RESET button for retrieving assist information or resetting the selected item. |

i Information

If equipped with an infotainment system, only the Settings menu in the infotainment system is supported and not the instrument cluster.

View modes

| View Modes | Explanation |
|----------------------|--|
| Utility group | This mode displays driving information such as the trip distance, fuel economy and etc. |
| Driving assist group | This mode displays: <ul style="list-style-type: none"> • Smart Cruise Control (if equipped) • Lane Keeping Assist • Lane Following Assist • Driver Attention Warning |
| Navigation group | This mode displays the navigation guidance. |
| Driving info. group | This mode displays the current operation conditions of Cruise Control, Smart Cruise Control, and Highway Driving Assists. |

The information provided may differ depending on which functions are available on your vehicle.

To reset the information, press and hold the OK button when the "**Since refueling**" is displayed. The trip distance, the average fuel economy, and total driving time will reset simultaneously.

Trip computer group

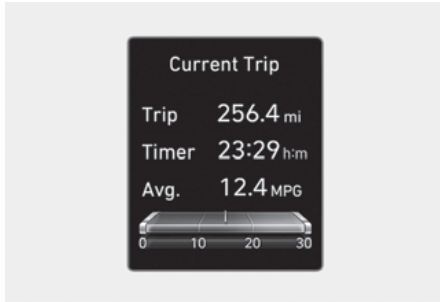

The trip computer group displays information related to vehicle driving parameters including fuel economy, tripmeter information, and vehicle speed. For more information, refer to the "Trip computer" section in this chapter.

Master warning group

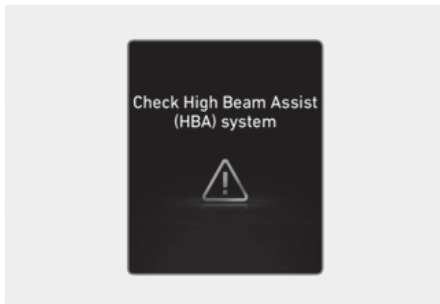

The Master Warning Light illuminates if one or more of the following occurs:

- Forward Collision-Avoidance Assist system malfunction
- Forward Collision-Avoidance Assist radar blocked
- Blind-Spot Collision-Avoidance Assist system malfunction (if equipped)
- Blind-Spot Collision-Avoidance Assist radar blocked (if equipped)
- Lamp malfunction (if equipped)
- High Beam Assist malfunction (if equipped)

- Smart Cruise Control malfunction (if equipped)
- Tire Pressure Monitoring System malfunction (if equipped)

If the issue is resolved, the Master Warning Light and the Master Warning icon are turned off.

Tire Pressure



For more information, refer to the "Tire Pressure Monitoring System (TPMS)" section in chapter 8.

Driving Assist group

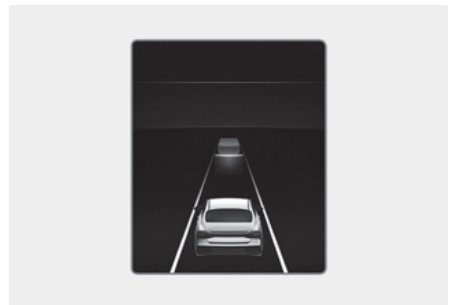

SCC/LFA/HDA

Displays the state of Smart Cruise Control (if equipped), Lane Following Assist, and Highway Driving Assist.

For more information, refer to each function information in chapter 7.

Navigation group

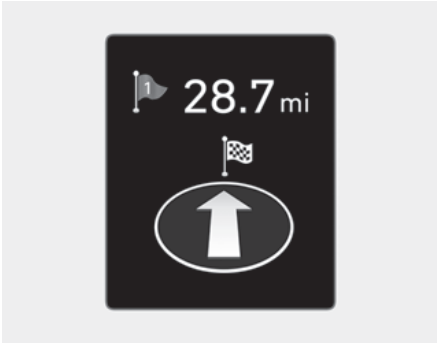

Turn-by-turn navigation and distance/time to destination appear when the Navigation group is selected.

Driving info. group

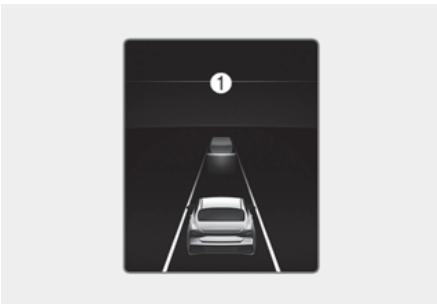

Driving information summary (1)

The current operation conditions of Cruise Control, Smart Cruise Control and Highway Driving Assist. It does not show such information while driving assist mode is working.



Driving information summary (2)

The current operation conditions of Cruise Control, Smart Cruise Control and Highway Driving Assist.

Warning message group

When the warning message light appears, check the detailed information in warning message group.

Vehicle settings (infotainment system)

 if equipped

Vehicle Settings in the infotainment system provides user options for a variety of settings including door lock/unlock features, convenience features, driver assistance settings, etc.

Vehicle Settings menu

- Driver Assistance
- Cluster
- Climate
- Seat
- Lights
- Door
- Convenience

These options may differ depending on which functions are available on your vehicle.

WARNING

Do not operate the Vehicle Settings while driving. This may cause distraction resulting in an accident.

Setting your vehicle

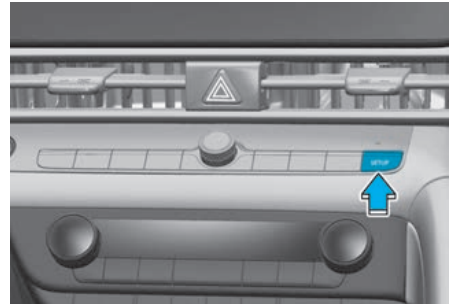

1. Press the SETUP button on the main keyboard.
2. Select **Vehicle** to change the Vehicle Settings.

The infotainment system may change after software updates. For more information, refer to the manual provided in the infotainment system and the quick reference guide.

5. Convenience features

| | |
|---|------|
| Accessing your vehicle..... | 5-4 |
| Remote key..... | 5-4 |
| Smart key..... | 5-7 |
| Immobilizer system..... | 5-14 |
| Hyundai digital key..... | 5-14 |
| Digital key (smartphone)..... | 5-14 |
| Digital key (Card key)..... | 5-19 |
| Used vehicle/digital key maintenance..... | 5-24 |
| Limitations of the system..... | 5-24 |
| Door locks..... | 5-25 |
| Operating door locks from outside the vehicle..... | 5-25 |
| Operating door unlocks from inside the vehicle..... | 5-26 |
| Auto door lock/unlock features..... | 5-28 |
| Child-protector rear door locks..... | 5-28 |
| Theft-alarm system..... | 5-29 |
| Rear Occupant Alert (ROA)..... | 5-30 |
| Rear occupant alert operations..... | 5-30 |
| Steering wheel..... | 5-30 |
| Motor Driven Power Steering (MDPS)..... | 5-30 |
| Tilt/telescopic steering..... | 5-31 |
| Horn..... | 5-31 |
| Mirrors..... | 5-32 |
| Inside rearview mirror..... | 5-32 |
| Side view mirrors..... | 5-38 |
| Windows..... | 5-40 |
| Power windows..... | 5-41 |
| Sunroof..... | 5-44 |
| Sunshade..... | 5-44 |
| Tilt open/close..... | 5-45 |
| Slide open/close..... | 5-45 |
| Automatic reversal..... | 5-46 |
| Resetting the sunroof..... | 5-47 |
| Sunroof open warning..... | 5-47 |
| Hood..... | 5-48 |
| Opening the hood..... | 5-48 |

| | |
|--|------|
| Closing the hood | 5-48 |
| Trunk | 5-49 |
| Emergency trunk safety release | 5-50 |
| Smart Trunk release | 5-51 |
| Fuel filler door | 5-54 |
| Opening the fuel filler door | 5-54 |
| Closing the fuel filler door | 5-54 |
| Exterior lights | 5-56 |
| Lighting control | 5-56 |
| High beam operation | 5-57 |
| Turn signals and lane change signals | 5-58 |
| Interior lights | 5-59 |
| Interior lights auto off | 5-59 |
| Mood lamp | 5-60 |
| Rear room lamp | 5-60 |
| Vanity mirror lamp | 5-60 |
| Luggage compartment lamp | 5-61 |
| Welcome system | 5-61 |
| Door handle light | 5-61 |
| Headlight and parking light | 5-62 |
| Interior light | 5-62 |
| High Beam Assist (HBA) | 5-62 |
| High Beam Assist settings | 5-62 |
| High Beam Assist operation | 5-63 |
| High Beam Assist malfunction and limitations | 5-63 |
| Wipers and washers | 5-65 |
| Windshield wipers | 5-65 |
| Front windshield washers | 5-66 |
| Manual climate control system | 5-67 |
| Heating and air conditioning | 5-68 |
| System operation | 5-73 |
| System maintenance | 5-75 |
| Automatic climate control system | 5-77 |
| Automatic heating and air conditioning | 5-78 |
| Manual heating and air conditioning | 5-79 |

5. Convenience features

| | |
|--|-------|
| System operation..... | 5-85 |
| System maintenance | 5-86 |
| Windshield defrosting and defogging | 5-88 |
| Manual climate control system..... | 5-88 |
| Automatic climate control system..... | 5-89 |
| Defogging logic..... | 5-90 |
| Rear window defroster | 5-91 |
| Auto defogging system (only for automatic climate control system) | 5-91 |
| Climate control additional features | 5-92 |
| Sunroof inside air recirculation | 5-92 |
| Automatic ventilation | 5-92 |
| Automatic controls for the driver based on climate control system settings | 5-93 |
| Storage compartment..... | 5-93 |
| Center console storage | 5-94 |
| Glove box..... | 5-94 |
| Interior features | 5-94 |
| Cup holder..... | 5-94 |
| Sunvisor | 5-95 |
| Power outlet | 5-95 |
| USB charger..... | 5-96 |
| Wireless smartphone charging system | 5-97 |
| Clock | 5-99 |
| Coat hook | 5-99 |
| Infotainment system | 5-100 |
| USB port..... | 5-100 |
| Antenna | 5-100 |
| Steering wheel audio controls | 5-101 |
| Infotainment system..... | 5-102 |
| Voice recognition..... | 5-102 |
| Bluetooth® wireless technology | 5-102 |
| How vehicle radio works | 5-103 |

Accessing your vehicle

Remote key

 if equipped

Your HYUNDAI uses a remote key that is used to lock or unlock the driver's and passenger's doors or the trunk.



- (1) Door Lock
- (2) Door Unlock
- (3) Trunk Unlock
- (4) Panic

Locking your vehicle (1)

1. Close all the doors, hood, and trunk.
2. Press the Door Lock button (1) on the remote key. The doors are locked. The hazard warning lights blink.
3. Make sure the doors are locked by pulling the outside door handle.

WARNING

Do not leave the Remote Key in your vehicle with children that are unattended or unsupervised.

Children could unintentionally place the key in the ignition switch or operate the power windows and other controls, or even cause the vehicle to move, resulting in serious injury or death.

Unlocking your vehicle (2)

Press the Door Unlock button (2) on the remote key. The doors are unlocked. The hazard warning lights blink two times.

Two press unlock setting

If you press the door unlock button on the remote key again within four seconds, then all the doors are unlocked. Two press unlock setting can be changed according to owner's preference in the instrument cluster User Settings mode.

User settings mode method

You can activate or deactivate the Two Press Unlock feature from the Settings menu in the instrument cluster.

Select: **User Settings > Door > Two Press Unlock**

For more information, refer to the "Cluster display (Type A)" section in chapter 4.

Information

After unlocking the doors, the doors are locked automatically after 30 seconds unless a door is opened.

Opening the trunk (3)

Press and hold the trunk Open button (3) for more than one second. The trunk is unlocked. The hazard warning lights blink two times.

Using panic alarm (4)

The horn sounds and the hazard warning lights blink for about 30 seconds if this button is pressed for more than 1 second. To stop the horn and lights, press any button on the remote key.

i Information

The word "HOLD" on the panic button means you must press and hold for more than one second to sound the panic alarm.

Starting the vehicle

For more information, refer to the "Key ignition switch" section in chapter 6.

NOTICE

To prevent damaging the remote key:

- Keep the remote key away from liquids or any type of extreme heat. If water or liquid gets into the remote key or the remote is subjected to extreme heat, it may result in damage to the internal circuit. This could void the vehicle warranty.
- Avoid dropping or throwing the remote key.
- Protect the remote key from extreme temperatures.

Mechanical key

 if equipped



If the remote key does not operate normally, you can lock or unlock the door by using the mechanical key.

To unfold the key, press the release button. The key unfolds automatically.

To fold the key manually, press the release button.

NOTICE

Do not fold the key without pressing the release button. The remote key may be damaged.

Remote key precautions

The remote key may not work if any of the following occur:

- The key is in the ignition switch.
- The maximum operating distance limit is exceeded (about 32 ft. (10 m)).
- The remote key battery is weak.
- Other vehicles or objects may block the signals.
- The weather is extremely cold.
- The remote key is close to a radio transmitter such as radio station or airport that can interfere with normal operation of the remote key.

When the remote key does not work correctly, unlock and lock the door with the mechanical key. If you have a problem with the remote key, contact an authorized HYUNDAI dealer.

If the remote key is in close proximity to your mobile phone, the signals could be blocked by your mobile phone's operational signals.

This is especially important when the phone is active such as making and receiving calls, text messaging, and/or sending/receiving emails.

Avoid placing the remote key and your mobile phone in the same location and always try to maintain an adequate distance between the two devices.

NOTICE

Keep the remote key away from electromagnetic materials that may block electromagnetic waves to the key surface.

Battery replacement

Battery type: CR2032

To replace the battery:



1. Insert a slim tool into the slot and gently open the cover.
2. Remove the old battery and insert a new one. Make sure the battery position is correct.

3. Reinstall the rear cover of the remote key.

If you suspect your remote key might have sustained some damage or you feel your remote key is not working correctly, contact an authorized HYUNDAI dealer.

! WARNING

This product contains a button battery.

If swallowed, a lithium button battery can cause severe or fatal injuries within 2 hours. Keep batteries out of reach of children.

If you think batteries may have been swallowed or placed inside any part of the body, seek immediate medical attention.

i Information



An inappropriately disposed battery may be harmful to the environment and human health. Always dispose of a used battery according to your local law(s) or regulations.

Smart key

 if equipped

Your HYUNDAI may be equipped with a smart key that can be used to lock or unlock the doors, trunk, and start the engine.

Type A

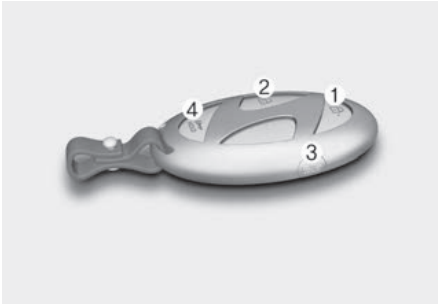

Type B

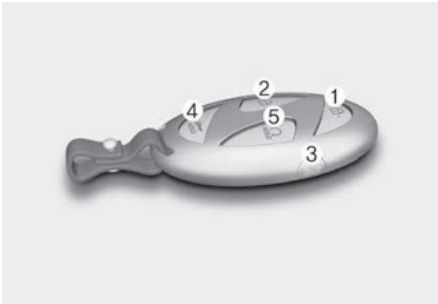

- (1) Door lock
- (2) Door unlock
- (3) Trunk Open
- (4) Panic
- (5) Remote Start (if equipped)

Locking your vehicle (1)

Button type

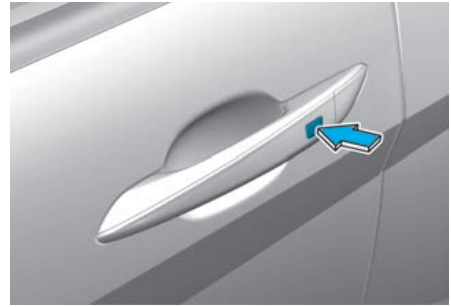

To lock:

1. Close all doors.
2. Have the smart key with you.
3. Press the door handle button or press the Door Lock button (1) on the smart key. The chime sounds and hazard warning lights blink. Also, the side view mirrors fold if **On door unlock** or **On driver approach** is selected from the Settings menu in the instrument cluster or infotainment system (if equipped).
4. Make sure the doors are locked by pulling the outside door handle.

Touch sensor type

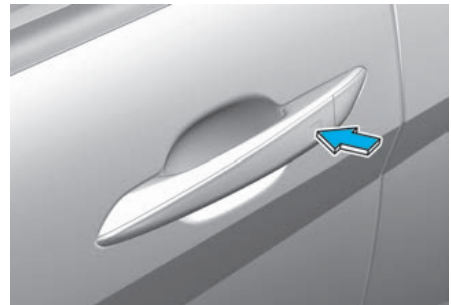

To lock:

1. Close all doors, hood, and trunk.
2. Have the smart key with you.

3. Touch the outer part of the door handle on or near the handle detent for about 1 second or until you hear the door locks actuate. The chime sounds and hazard warning lights blink. Also, the side view mirrors fold if **On door unlock** or **On driver approach** is selected from the Settings menu in the instrument cluster or infotainment system (if equipped).
4. Make sure the doors are locked by pulling the outside door handle.

Information

- The door handle button or touch sensor only operates when the smart key is within 28-40 in. (0.7-1 m) from the outside door handle.
- If you lock the door with the touch sensor, the doors cannot be unlocked with the touch sensor within 3 seconds.
- If you lock the doors using the door handle button or touch sensor, the doors are not locked under the following circumstances:
 - The Smart Key is in the vehicle.
 - The Button Start ignition switch is in the ACC or ON position.
 - Any door is open (except for the trunk).

If this occurs, a chime sounds for about 3 seconds. Check the vehicle before attempting to lock the vehicle again.

Information

Before you leave your vehicle with the Smart Key, verify that your vehicle is locked. When using the touch sensor on the front door handle, listen to hear that the lock has actuated, and then pull the handle within 3 seconds to confirm the doors are locked.

(If it has been longer than 3 seconds, verify the doors are locked by pressing the lock button on the Smart Key. You can hear a single beep.)

WARNING

Do not leave the Smart Key in your vehicle with children that are unattended or unsupervised.

Children could unintentionally press the Button Start ignition switch or could operate the power windows or other vehicle controls or even cause the vehicle to move. This may result in serious injury or death.

Unlocking your vehicle (2)

Button type

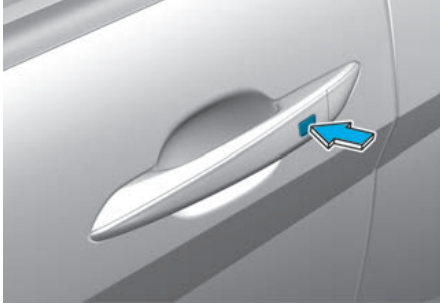

To unlock:

1. Have the smart key with you.
2. Press the door handle button or press the Door Lock button (2) on the smart key. The chime sounds and hazard warning lights blink two times. Also, the side view mirrors unfold if **On door unlock** or **On driver approach** is selected from the Settings menu in the instrument cluster or infotainment system (if equipped).
 - If you unlock the doors using the passenger side door handle, all the doors are unlocked. If you unlock the doors using the driver side door handle, either the driver's side door is unlocked or all the doors are unlocked depending on the setting for the Two Press Unlock feature. Change the Driver Door unlock mode by referring to "Setting the Two Press Unlock feature".

Touch sensor type



To unlock:

1. Have the smart key with you.
2. Grab the door handle to activate the door unlock touch sensor. The chime sounds and hazard warning lights blink two times. Also, the side view mirrors unfold if **On door unlock** or **On driver approach** is selected from the Settings menu in the instrument cluster or infotainment system (if equipped).
 - If you unlock the doors using the passenger side door handle, all the doors are unlocked. If you unlock the doors using the driver side door handle, either the driver's side door is unlocked or all the doors are unlocked depending on the setting for the Two Press Unlock feature. Change the Driver Door unlock mode by referring to "Setting the Two Press Unlock feature".

i Information

- The door handle button or touch sensor only operates when the smart key is within 28-40 in. (0.7-1 m) from the outside door handle.
- After unlocking the doors, the doors are locked automatically after 30 seconds unless a door is opened.

Setting the Two Press Unlock feature

You can activate or deactivate the Two Press Unlock feature from the Settings menu in the instrument cluster or infotainment system. Select:

- **User Settings > Door > Two Press Unlock** (for instrument cluster type)
- **Settings > Vehicle > Door > Two Press Unlock** (for infotainment system type)

i Information

- For more information on the cluster type Settings menu, refer to the "Cluster display (Type A)" section in chapter 4.
- The infotainment system may change after software updates. For more information, refer to the user's manual provided in the infotainment system and the quick reference guide.

Setting the door lock/unlock prevention feature

The doors may lock or unlock if the touch sensor of the outside door handle is recognized while washing your vehicle or due to heavy rain.

To prevent unintentional door lock or unlock:

Press the lock button on the smart key and immediately press the unlock button along with the lock button for more than 4 seconds. The hazard warning lights blink four times. At this time, the doors do not lock or unlock even though the touch sensor is touched on the outside door handle. To deactivate the function, press the door lock or unlock button on the smart key.

i Information

- During a car wash or rain, in order to minimize unintentional operation of the touch sensor, the touch sensor may become insensitive. This is not a malfunction.
- The doors may not lock or unlock in the following situations.
 - If the touch sensor is touched with gloves on.
 - If the door is suddenly approached.

Unlocking the trunk (3)

To open:

1. Make sure you have the smart key in your possession.
2. Press the trunk open/close button on the vehicle or press and hold the trunk Open button (3) on the smart key for more than 1 second. The hazard warning lights blink twice and the trunk is unlocked.
3. Pull up on the trunk to open.

Using panic alarm (4)

The horn sounds and the hazard warning lights blink for about 30 seconds if this button (4) is pressed for more than 1 second. To stop the horn and lights, press any button on the smart key.

Remotely starting the vehicle (5)

 if equipped

To start the vehicle remotely:

1. Press the door lock button on the smart key. You must be within about 32 ft. (10 m) from the vehicle.
2. Press and hold the Remote Start button (7) on your smart key for more than 2 seconds. You must press the button within 4 seconds from when you have pressed the door lock button. The hazard warning lights blink and the engine starts.
3. To turn off the engine, press the Remote Start button (7) once.

i Information

- In case of the manual operation, the climate control system will be maintained even when the engine is turned OFF. However, the automatic operation is set to 72 °F (22 °C). The climate control system remain set before the engine is turned OFF.
- The engine turns off if you do not get on the vehicle within 10 minutes after remotely starting the vehicle.
- The Remote Start button may not operate if the smart key is not within 32 ft. (10 m) from the vehicle.
- The vehicle does not remotely start if the hood or trunk is open.
- Do not idle the engine for a long time.

Starting the vehicle

Some models are equipped with a Button Start ignition switch instead of a key cylinder. You can leave your smart key in your pocket or purse when you start your vehicle.

For more information, refer to the "Push button start ignition switch" section in chapter 6.

i Information

If the smart key is not moved for some time, the detection function for smart key operation will pause. Lift the smart key to activate the detection again.

NOTICE

To prevent damaging the smart key:

- Keep the smart key in a cool, dry place to avoid damage or malfunction. Exposure to moisture or high temperature may cause the internal circuit of the smart key to malfunction. This may not be covered under warranty.
- Avoid dropping or throwing the smart key.
- Protect the smart key from extreme temperatures.

Mechanical key

If the smart key does not operate normally, you can lock or unlock the driver's door by using the mechanical key.

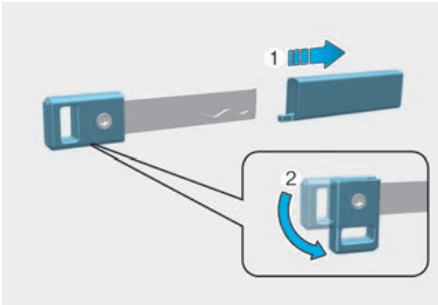

Turn the knob (2) of the mechanical key after removing the key protector (1).

After using the mechanical key, turn the key knob (2) and insert the key protector (1).

Key cylinder (Driver door)

A key cylinder is located on the driver side door handle hidden behind a plastic cover. Using the mechanical key, push and hold the key cylinder cover release button located on the underside of the door handle refer to "Door locks" section in this chapter.

Use the mechanical key inserted into the release button slot to open the cover outward. Once the cover is off, the mechanical key can be inserted into the key cylinder to lock or unlock the vehicle.

To reinstall the mechanical key into the smart key, put the key into the key hole and push inward until a click sound is heard.

Loss of a smart key

A maximum of two smart keys can be registered to a single vehicle. If you happen to lose your smart key, immediately take the vehicle and remaining key to your authorized HYUNDAI dealer or tow the vehicle, if necessary.

Smart key precautions

The smart key may not work if any of the following occur:

- The smart key is close to a radio transmitter such as radio station or airport that may interfere with normal operation of the transmitter.
- The smart key is near a mobile two way radio system or a mobile phone.
- Another vehicle's smart key is being operated close to your vehicle.
- If your windows are tinted, especially with metallic window tint, it may cause frequency interference, reducing the smart key operating range.
- The vehicle battery is discharged.
- Connecting an external device to the power outlet and placing the smart key near the external device.

If the smart key does not work correctly, open and close the door with the mechanical key. To start the engine, press the Button Start ignition switch directly with the smart key. If you have a problem with the smart key, contact an authorized HYUNDAI dealer.

If the smart key is in close proximity to your mobile phone, the signal could be blocked by your mobile phone's operational signals. This is specifically relevant when the phone is active such as making and receiving calls, text messaging, and/or sending/receiving emails. If possible, avoid keeping the smart key and your mobile phone in the same location such as pants or jacket pocket to avoid interference between the two devices.

NOTICE

- Keep the smart key away from electromagnetic materials that may block electromagnetic waves to the key surface.
- Always have the smart key with you when leaving the vehicle. If the smart key is left near the vehicle, the vehicle battery may be discharged.

Battery replacement

Battery Type: CR2450

To replace the battery:

1. Put the slim tool into the key hole (1) to pry open the rear cover of the smart key.



2. Remove the old battery and insert a new battery. Make sure the battery position is correct.

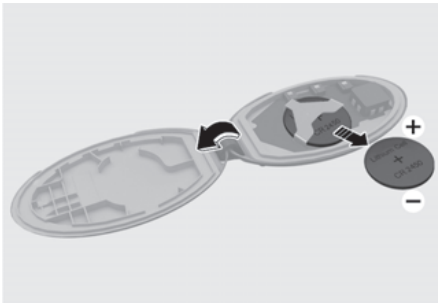

3. Reinstall the rear cover of the smart key.

If you suspect your smart key might have sustained some damage, or you feel your smart key is not working correctly, contact an authorized HYUNDAI dealer.

! WARNING

This product contains a button battery. If swallowed, a lithium button battery can cause severe or fatal injuries within 2 hours. Keep batteries out of reach of children.

If you think batteries may have been swallowed or placed inside any part of the body, seek immediate medical attention.

i Information

An inappropriately disposed battery may be harmful to the environment and human health. Always dispose of a used battery according to your local law(s) or regulations.

Immobilizer system

The immobilizer system helps protect your vehicle from theft. If an improperly coded key (or other device) is used, the engine's fuel system is disabled.

When the ignition switch is in the ON position, the immobilizer system indicator should come on briefly, then go off. If the indicator starts to blink, the system does not recognize the coding of the key.

Move the ignition switch to the LOCK/OFF position, then to the ON position again.

The system may not recognize your key's coding if another immobilizer key or other metal object (e.g. key chain) is near the key. The engine may not start because the metal may interrupt the transponder signal from transmitting normally.

If the system repeatedly does not recognize the coding of the key, contact an authorized HYUNDAI dealer.

Do not attempt to modify this system or add other devices to it. Electrical problems may occur making your vehicle inoperable.

i Information

To prevent theft of your vehicle, do not leave spare keys anywhere in your vehicle. Your immobilizer password is a customer unique password and should be kept confidential.

NOTICE

Avoid exposing the key to moisture, static electricity, and rough handling. The Immobilizer system may malfunction.

Hyundai digital key

 if equipped

Hyundai digital key provides convenience to the driver, which the driver can use to lock or unlock the driver and passenger doors or the trunk and turn on the vehicle.

Digital key (smartphone)

i Information

- Hyundai digital keys are only available on smartphone that support digital key functions, and digital key functions of smartphones are provide by smartphone manufacturers.
- Available smartphone models can be found on smartphone manufactures' website or HYUNDAI website.
- Depending on the availability of service on the vehicle, some functions may not operated.

Setting your smartphone

To use the digital key (smartphone), download the Bluelink App and sign up Hyundai account and service.

For more information about Bluelink, refer to the infotainment system guide.

Registering your digital key (smartphone)

- Turn on the vehicle with a smart key and have your smart key with you in the vehicle.
- After selecting **Digital Key > Set Up Digital Key** from the My Hyundai App in the smartphone, register the digital key according to the guidance in the smartphone screen.
 - Place your smartphone on the vehicle authentication pad (wireless charging pad) with the screen facing up. (In case of Apple WATCH, the watch face must be on the pad).

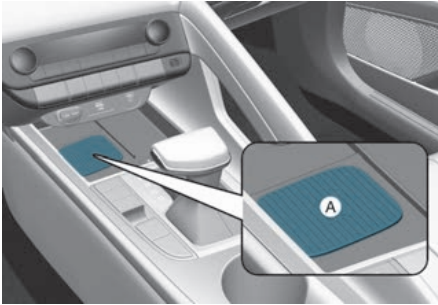

- When the digital key (smartphone) is saved, a message appears on the infotainment system screen.

i Information

- The NFC Antenna position on Samsung device can be found in the following path: **Settings** > **Connections** > **NFC and contactless payments**.



- The NFC Antenna position on Apple iPhone is located at the top of the rear and Apple WATCH is located at the center of the screen.
- Ensure that the NFC Antenna position on the smartphone is in contact with the vehicle authentication pad (wireless charging pad).
- The location of the NFC Antenna on the smartphone may vary by phone model, so please contact the smartphone manufacturer for details.

- NFC communication may not work for some smartphones depending on the internal structure of the smartphone. Move the smartphone to the left or right of the indoor authentication pad (wireless charging pad) to operate.

To register the digital key (smartphone) from the infotainment system

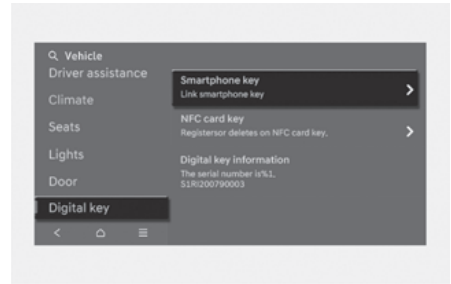

If you cannot register the digital key (smartphone) with the My Hyundai app, try registering from the infotainment system.

1. Turn off the vehicle, and then turn on the vehicle with a smart key and have your smart key with you in the vehicle.
 2. Put the gear in P (Park), from the infotainment system Settings menu, select **Settings** > **Vehicle** > **Digital key** > **Smartphone key** and press the **Save** button.
 3. Place your smartphone on the vehicle authentication pad (wireless charging pad) with the screen facing up. (In case of Apple WATCH, the watch face must be on the pad).
- When the digital key (smartphone) is saved, a message appears on the infotainment system screen.

i Information

- If you want to register a different digital key (smartphone), refer to the "Deleting your digital key (smartphone)" and delete the digital key (smartphone) before re-registering. An active Digital Key can be shared through the My Hyundai app with a different smartphone.
- During the digital key saving process, the process may cancel when:
 - The smartphone is removed from the vehicle authentication pad (wireless charging pad)
 - The infotainment system screen is changed
 - The engine is turned off
 - The gear is shifted
- The registering process does not start if a smart key is not in the vehicle.
- Some smartphones may not start the registering process depending on the internal structure. Move the smartphone to the left or right on the vehicle authentication pad (wireless charger pad) and try registering the smartphone.

Using the digital key (smartphone)

The driver can lock or unlock the door by placing the smartphone on the outside door handle, and the vehicle can be started by placing the smartphone on the vehicle authentication pad (wireless charging pad).

Samsung smartphone

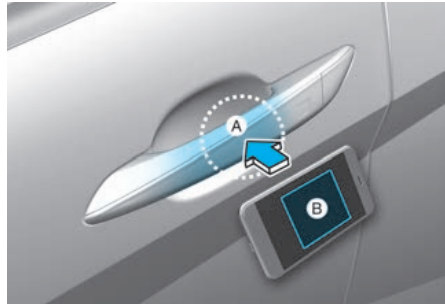

[A] Door handle authentication pad
[B] NFC Antenna

i Information

- The location of the NFC Antenna on the smartphone may vary by phone model, so please contact the smartphone manufacturer for details.
- The NFC Antenna position on Samsung device can be found in the following path: **Setup > Connections > NFC and contactless payments**.
- The NFC Antenna position on Apple iPhone is located at the top of the rear [A] and Apple WATCH is located at the center of the screen [B].



- Touch the Door handle NFC Antenna position with the back of your smartphone. (In case of Apple WATCH, the watch face must be on the pad).

Locking/Unlocking the doors

- If the driver places the digital key (smartphone) NFC antenna to the driver's or passenger's door handle authentication pad (A) for more than 2 seconds, the door locks or unlocks.
- After unlocking the doors, the doors are automatically re-lock after 30 seconds unless a door is opened.
- If the smartphone digital key does not operate, try again after moving the smartphone away from the door handle authentication pad (more than 4 in. (0.1 m)).

i Information

You cannot lock your vehicle using the digital key (smartphone) if any of the following occurs:

- The smart key is in the vehicle.
- The Engine Start/Stop button is in the ACC or ON position.
- Any of the doors are open.

Starting the vehicle

After placing your registered digital key (smartphone) on the vehicle authentication pad (wireless charging pad), depress the brake pedal and press the Engine Start/Stop button.

After starting the vehicle, the digital key (smartphone) may be removed from the vehicle authentication pad (wireless charging pad).

For more details on the basic way to start the vehicle, refer to the "Push button start ignition switch" section in chapter 6.

i Information

If a shared digital key (smartphone) is used for the first time, the activating time may take longer.

- Place the shared digital key (smartphone) on the door handle authentication pad until the vehicle door lock/unlock activates.
- If a shared digital key (smartphone) is first used on the vehicle authentication pad (wireless charger pad), the initial start of the vehicle may fail.
- If the door lock/unlock is activated once with the shared digital key (smartphone) or the vehicle is started with the digital key (smartphone) on the vehicle authentication pad, the digital key (smartphone) is registered in the vehicle.

WARNING

The vehicle can be started when the registered smartphone is placed on the vehicle authentication pad (wireless charging pad). Therefore, do not leave unsupervised children or people who are not aware of the system since it can result in serious injury or death. In addition, always have the registered smartphone with you to prevent vehicle theft when leaving the vehicle.

Deleting your digital key (smartphone)

Turn on the vehicle with a smart key. Have your smart key with you in the vehicle.

Deleting all registered digital key (smartphone)



To delete all the registered digital key (smartphone), from the Settings menu select **Setup > Vehicle > Digital Keys > Smartphone key > Delete all** in the infotainment system.

- The "**Delete all**" button is disabled if there is no registered digital key (smartphone).

Deleting my registered digital key (smartphone)

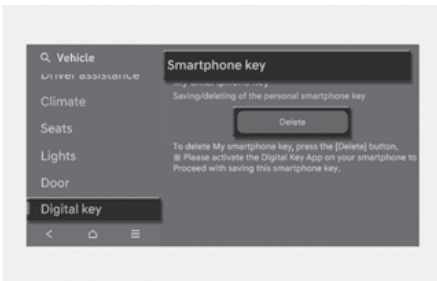

To delete only my registered digital key (smartphone), from the Settings menu select **Setup > Vehicle > Digital Keys > Smartphone key > My Smartphone Key > Delete** in the infotainment system.

- If a shared digital key (smartphone) is registered, it cannot be deleted.
- A new smartphone can be registered after deleting the existing digital key (smartphone) from "**My Smartphone Key**" menu.

i Information

- If the registered digital key (smartphone) is deleted, the digital key saved in the smartphone is also deleted.
- If the digital key is deleted from the smartphone, the digital key (smartphone) registered in the vehicle is also deleted.
- The shared digital key registered in the vehicle cannot be deleted individually.
- Even though the Blue Link® App is deleted from the smartphone, the digital key saved in the smartphone is not deleted.
- Management of the digital key saved in the smartphone is available from the Digital Key App provided by the smartphone manufacturer.

Digital key (Card key)

How to register digital key (Card Key)

To use the card key as a digital key, follow the following procedure.

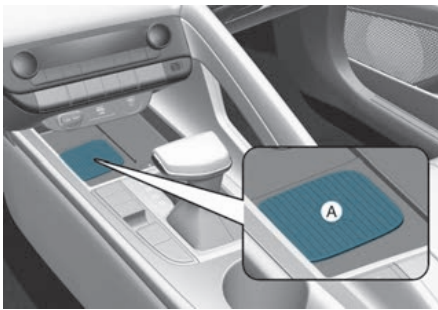
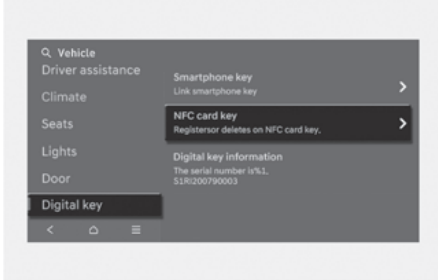

[A] Vehicle authentication pad (Wireless charging pad)

1. Have both of your smart keys with you in the vehicle.
2. Select **Setup > Vehicle > Digital Keys > NFC Card Key** from the Settings menu, and check whether "Use" is selected in the infotainment system.
3. Place your card key on the vehicle authentication pad (wireless charging pad) while the engine is on.
4. Register your card key by selecting **Setup > Vehicle > Digital Keys > NFC Card Key > Save** from the Settings menu in the infotainment system.

i Information

- Only one digital key (card key) can be registered to the vehicle. If it must be replaced, delete the existing card key before registering the new card key.
- To register a digital key (card key), both of your smart keys must be in the vehicle.
- Once a digital key (card key) is registered, it cannot be registered in another vehicle. It is possible to re-register it to the original vehicle.

Using the digital key (card key)

The driver can lock or unlock the door by placing the card key on the outside door handle, and the vehicle can be started by placing the card key on the vehicle authentication pad (wireless charging pad).

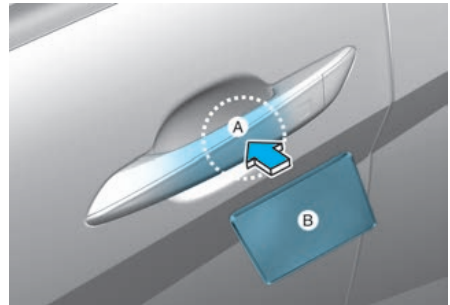

[A] Door handle authentication pad
[B] Card key NFC Antenna

Locking/Unlocking the doors

If the driver places the digital key (card key) to the driver's or passenger's door handle authentication pad (A) for more than 2 seconds, the door locks or unlocks.

After unlocking the doors, the doors are automatically re-locked after 30 seconds unless a door is opened.

i Information

You cannot lock your vehicle using the digital key (card key) if any of the following occurs:

- The smart key is in the vehicle.
 - The Engine Start/Stop button is in the ACC or ON position.
 - Any of the doors are open.
-

Starting the vehicle

After placing your registered digital key (card key) on the vehicle authentication pad (wireless charging pad), depress the brake pedal and press the Engine Start/Stop button.

For more information on the basic way to start the vehicle, refer to the "Push button start ignition switch" section in chapter 6.

⚠ WARNING

The vehicle can be started when the registered card key is placed on the vehicle authentication pad (wireless charging pad). Therefore, do not leave unsupervised children or people who are not aware of the system since it can result in serious injury or death. In addition, always have the registered card key with you to prevent vehicle theft when leaving the vehicle.

NOTICE

- The digital key (card key) may not work under the following conditions:
 - The digital key (card key) is not placed on the door handle authentication pad or vehicle authentication pad (wireless charging pad) correctly.
 - The digital key (card key) is near NFC-enabled cards such as credit cards or smartphones.

If the digital key (card key) does not work, try again after moving the digital key (card key) away from the door handle authentication pad (more than (4 in. (0.1 m)).
 - The digital key (card key) can be damaged by impacts. If the digital key (card key) is damaged, replace the digital key (card key) with a new one and register it again.
 - Long-time exposure to high temperature may cause the digital key (card key) to malfunction. Be careful not to expose the digital key (card key) to direct sunlight or high temperature.
 - Leaving the digital key (card key) on the in-vehicle authentication pad (wireless charging pad) while driving may cause the digital key (card key) to malfunction. Remove the digital key (card key) from the in-vehicle authentication pad (wireless charging pad) after starting the vehicle.
 - Keep the digital key (card key) away from the smartphone when charging the smartphone. If the digital key (card key) is placed between the smartphone and the in-vehicle authentication pad (wireless charging pad) while the smartphone is being charged, the digital key (card key) may malfunction. For example, when charging smartphone while the digital key (card key) is attached to the back of the smartphone case.
-

Deleting your digital key (card key)

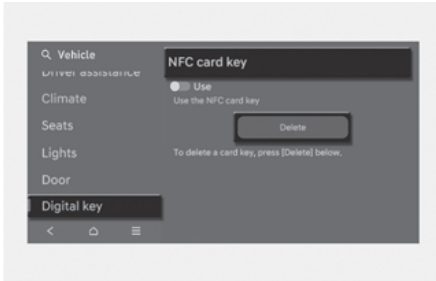

1. Turn on the engine with a smart key. Have your smart key with you in the vehicle.
2. From the infotainment system settings menu, select **Setup > Vehicle > Digital Keys > NFC Card Key > Delete**.
 - The "Delete" button is disabled if there is no digital key (card key) registered.

Personalized profile and vehicle settings

You can set the registered digital key (smartphone) profiles for Driver 1 and Driver 2. When you use the digital key (smartphone), the vehicle can be set to the user-defined personalized profile (includes items such as vehicle settings and audio preferences).

Linking/Unlinking profile

How to link user profile

1. Select **Setup > User Profile > Profile Settings > Link Digital Key (Smartphone)** from the Settings menu in the infotainment system.
2. Select "Link" to connect the registered smartphone's digital key and the user's profile.
3. Follow the instructions according to the message on the infotainment system screen.

How to unlink user profile

Select **Setup > User Profile > Profile Settings**, and then deselect "Link Digital Key (Smartphone)" from Settings menu in the infotainment system.

- Unlinking is possible only when user profile is linked.

i Information

- User profile cannot be linked to both Driver 1 and Driver 2 that are connected to single smartphone. Personalization operates with the recently linked user profile, and the previously linked user profile will be automatically canceled.
- User profile link works only when the digital key is registered to the vehicle.
- Digital key (card key) cannot be linked with a user profile.
- If the user profile linked digital key in the smartphone is deleted, the digital key should be re-registered and personalized by linking the user profile again.

Vehicle personalization operation

- The personalization function linked with digital key works when the profile linked smartphone is placed on the outside door handle authentication pad to lock or unlock the doors.
- The profile set by the digital key can be changed manually from the infotainment system.
- The personalization function using the digital key can be operated after linking the digital key in the infotainment system profile menu.
- The personalization function works only when the vehicle is OFF or when the vehicle is started remotely. If the vehicle is not started remotely, the personalization function does not work with the digital key.

i Information

User profile operation according to door lock/unlock system is as follows:

| Item | Personalization Operation |
|---------------------------------|----------------------------|
| Initial value | Guest |
| Profile linked smartphone key | Linked profile |
| Profile unlinked smartphone key | Recently activated profile |
| NFC card key | |
| Smart key | |

Vehicle personalization with digital key

The available personalization function in the vehicle is as follows:

| System | Personalization Item | |
|--------------------------------------|----------------------|---|
| Infotainment system vehicle settings | Lamp | Blink number of one-touch signal lamps |
| | Cluster | Information display on the cluster, Voice volume, Welcome sound |
| | Seat | Seat position |
| | Door | Automatic door lock/unlock, Two Press Unlock |
| | Climate | Temperature Unit, Automatic ventilation |
| Infotainment system | Navigation | Preferred volume of the navigation system, Recent destination |
| | User preset | My menu list settings, Radio preset |
| | Phone connectivity | Bluetooth preferential connect CarPlay/Android Auto On/Off |
| Air conditioning | Operating condition | Latest operation setup of the following functions: Temperature, AUTO, air flow direction, air volume, air conditioner, air intake control, SYNC, Front windshield defroster, OFF |

CAUTION

If you leave the digital key after locking or unlocking the doors or starting up the vehicle with the smart key, the doors can be locked by the central door lock. Please carry around the digital key all the time.

Information

The infotainment system may change after software updates. For more information, refer to the manual provided in the infotainment system and the quick reference guide.

Used vehicle/digital key maintenance

Purchasing used vehicle

If any of the digital key devices (smartphone key, card key) are registered in the vehicle, the "**Digital key registered**" message appears once on the infotainment system screen or instrument cluster when the Engine Start/Stop button is in the ON position after unlocking the doors. When purchasing a used vehicle, make sure to check the message and delete the smartphone key and card key registered by the previous user and inform the purchase of a used vehicle through Hyundai Customer Care Center.

If the card key comes with the vehicle, check whether it operates properly.

Digital key maintenance

If you need to repaired or replaced your Digital Key system, make sure your smartphone key is still active. You may have to pair your phone again using the HYUNDAI Digital Key app.

Limitations of the system

- HYUNDAI Digital Key app on the smartphone and card key may not work if:
 - Smartphone battery or the vehicle battery is discharged.
 - NFC or Bluetooth is turned off on the smartphone settings.
 - The card key is in a wallet or card holder, or overlapped with other cards.
 - If you use a smartphone cover that uses wireless communication or is made of metal, remove the smartphone cover.
- The vehicle may not be controlled by the smartphone if any of the following occurs:
 - Other smartphone functions (calls, urgent call, audio or NFC payment), apps, or wireless earphones are operating.
 - The digital key app function such as basic setting or app launching is limited by the prior policy according to the manufacturer.

Door locks

Operating door locks from outside the vehicle

Using the mechanical key

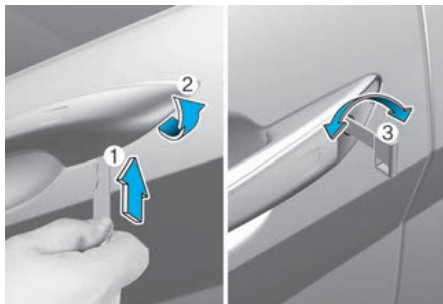

To unlock:

1. Pull the door handle.
2. Press the release button (1) located inside the bottom part of the cover with a mechanical key or flat-head screwdriver.
3. Carefully pull out the cover (2) while continuing to press the release button to remove the cover and expose the key cylinder.
4. Insert the mechanical key into the key cylinder and rotate (3) clockwise to unlock the vehicle and counterclockwise to lock the vehicle.
Once the doors are unlocked, they can be opened by pulling the door handle.

i Information

Only the driver's door can be locked/unlocked using the mechanical key.

NOTICE

- When removing the key cylinder cover, avoid scratching or breaking the plastic material.
- If the key cylinder cover freezes and cannot be removed easily, lightly tap on the cover or try to warm the cover by placing your hands around it and blowing warm air on it.
- Do not apply excessive force to the door and door handle.

Using the remote key

For more information, refer to the "Remote key" section in this chapter.

Using the smart key

For more information, refer to the "Smart key" section in this chapter.

i Information

- In cold and wet climates, door lock and door mechanisms may not work properly due to freezing conditions.
- If the door is locked/unlocked multiple times in rapid succession with either the vehicle key or door lock switch, the system may stop operating temporarily in order to protect the circuit and prevent damage to system components.

Operating door unlocks from inside the vehicle

With the door inside handle

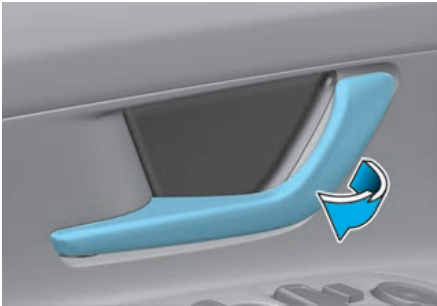

Driver door & Passenger door

If the inner door handle is pulled when the door is locked, the door is unlocked and opened.

Rear door - Two pull operation

If the inner door handle is pulled once when the door is locked, the door is unlocked. If the inner door handle is pulled once more, the door is opened.

With the central door lock/unlock switch

Driver's door



Front passenger's door

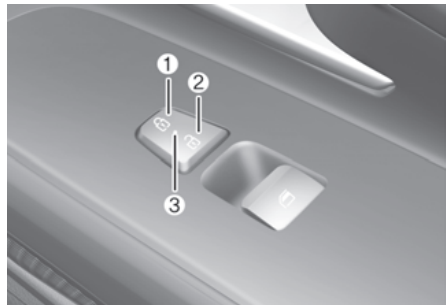

When pressing the (🔒) portion (1) on the switch, all vehicle doors are locked.

- If any door is opened, the doors are not locked even though the lock switch (1) of the door is pressed.

When pressing the (🔓) portion (2) on the switch, all vehicle doors are unlocked.

When all vehicle doors are locked, the indicator lights (3) on the driver's door and passenger's door turn off. If any door is unlocked, the indicator turns on.

In case of an emergency



In case of emergency such as when the battery is discharged, the only way to lock the door(s) is with the mechanical key from the outside key hole.

Doors without an outside key hole can be locked as follows:

1. Open the door.
2. Insert the key into the emergency door lock hole and turn the key to the lock position.
3. Close the door securely.

⚠ WARNING

- Always close and lock the doors while the vehicle is moving. If the doors are unlocked, the risk of being thrown from the vehicle in a collision increases.
- Do not pull the inner door handle of the driver's or passenger's door while the vehicle is moving.

⚠ WARNING

Do not leave the elderly, children, or animals unattended in your vehicle. An enclosed vehicle can become extremely hot and the elderly, unattended children or animals who cannot escape the vehicle may be seriously injured or killed.

⚠ WARNING

Always park your vehicle properly. Depress the brake pedal, change the gear to P (Park), apply the parking brake, move the ignition switch to the LOCK/OFF position, close all windows, lock all doors, and always take the keys with you.

⚠ WARNING

Be careful when opening doors and watch for vehicles, motorcycles, bicycles, or pedestrians approaching the vehicle to prevent serious injury or death.

***i* Information**

To exit the vehicle if the power door lock does not function:

- Operate the door unlock feature repeatedly (both electronic and manual) while simultaneously pulling on the door handle.
- Operate the other door locks and handles.
- Lower the driver's front window and use the mechanical key to unlock the door from outside.

Auto door lock/unlock features

Impact sensing door unlock system

All doors are automatically unlocked when an impact causes the airbags to deploy.

Speed sensing door lock system

 If equipped

All doors will be automatically locked when vehicle speed exceeds 9 mph (15 km/h).

You can activate or deactivate the Auto Door Lock/Unlock features from the User Settings Mode on the cluster display.

For more details, refer to "Cluster display (Type A)" in chapter 4. If your vehicle is equipped with additional navigation, please refer to the infotainment system manual separately supplied.

Child-protector rear door locks



The child safety lock is provided to help prevent children seated in the rear from accidentally opening the rear doors. The rear door safety locks must be used whenever children are in the vehicle.

The child safety lock is located on the edge of each rear door. When the child safety lock is in the lock position, the rear door does not open if the inner door handle is pulled.

To lock the child safety lock, insert a small flat blade tool (e.g. screwdriver or similar) (1) into the slot and turn it to the lock position as shown.

To allow a rear door to be opened from inside the vehicle, unlock the child safety lock.

WARNING

Never allow children to open the rear doors while the vehicle is moving. They may fall out of the vehicle. Be sure to use the rear door safety locks whenever children are in the vehicle.

Theft-alarm system

This system helps protect your vehicle and valuables. The horn sounds and the hazard warning lights blinks continuously if any of the following occur:

- A door is opened without using the remote key or smart key.
- The trunk is opened without using the remote key or smart key.
- The hood is opened.

The alarm continues for 30 seconds, then the system resets. To turn off the alarm, unlock the doors with the remote key or smart key.

The Theft Alarm System automatically sets 30 seconds after you lock the doors and the trunk. For the system to activate, you must lock the doors and the trunk from outside the vehicle by doing one of the following:

- Using the remote key or smart key.
- Pressing the button on the outside door handle with the smart key in your possession. (available with button type)
- Touching the touch sensor on the outside door handle with the smart key in your possession. (available with touch sensor type)

The hazard warning lights blink and the chime sounds once to indicate the system is armed.

Once the security system is set, opening any door, trunk, or hood without using the remote key or smart key causes the alarm to activate.

The Theft Alarm System is not set if the hood, trunk, or door is not fully closed. If the system is not set, check the hood, trunk, or doors are fully closed.

Do not attempt to modify this system or add other devices to it.

i Information

- Do not lock the doors until all passengers have left the vehicle. If a door is opened after the system is armed, the alarm is activated.
- If the vehicle is not disarmed with the remote key or smart key, open the doors using the mechanical key and turn the ignition switch to the ON position (for remote key) or start the engine by pressing the Button Start ignition switch with the smart key.
- If the system is disarmed by unlocking the vehicle, and a door or the trunk is not opened within 30 seconds, the doors are relocked and the system is rearmed automatically.

Rear Occupant Alert (ROA)

Rear Occupant Alert is provided to prevent the driver from leaving with any rear passenger left in the vehicle.

Rear occupant alert operations

When you turn off the engine and open the driver's door after opening and closing the rear door or trunk, the "**Check rear seats**" warning message appears on the instrument cluster.

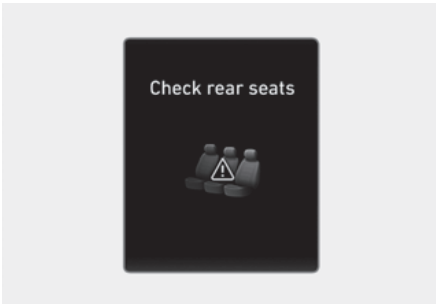

WARNING

Rear Occupant Alert provides information to the driver to check the rear seats but it does not detect whether there is an object or passenger. Always check the rear seats when leaving the vehicle.

Information

The open and close history of the rear door is initialized if the driver turns off the engine and lock vehicle doors.

However, the alarm may sound again whenever the driver's door is opened if the previous history of the rear door is not initialized.

Steering wheel

Motor Driven Power Steering (MDPS)

The system assists you with steering the vehicle. If the vehicle is turned off or if the power steering system becomes inoperative, you may still steer the vehicle, but it requires increased steering effort.

If you notice any change in the effort required to steer during normal vehicle operation, contact an authorized HYUNDAI dealer.

CAUTION

If the Motor Driven Power Steering () warning light and the message, "Check motor driven power steering" illuminate on the instrument cluster, you can continue to steer the vehicle, but it requires increased effort. Contact an authorized HYUNDAI dealer and have the system inspected as soon as possible.

Information

During normal vehicle operation:

- The steering effort may be high immediately after moving the ignition switch to the ON position.
This happens as the system performs the MDPS system diagnostics. When the diagnostics are completed, the steering wheel effort returns to its normal condition.
- When the battery voltage is low, you might have to use more effort to steer. This is a temporary condition and returns to normal after charging the battery.
- A noise may be heard from the MDPS relay after the ignition switch is in the ON or LOCK/OFF position.

- Motor noise may be heard when the vehicle is at a stop or driving at low speeds.
- When you operate the steering wheel in low temperatures, abnormal noise may occur. When the temperature rises, the noise disappears.
- When an error is detected from MDPS, the steering effort assist function is not activated. Instrument cluster warning lights may illuminate or the steering effort may be high. If these symptoms occur, drive the vehicle to a safe location as soon as possible. Have the system inspected by an authorized HYUNDAI dealer as soon as possible.

Tilt/telescopic steering

Adjust the steering wheel toward your chest, not toward your face. Make sure you can see the instrument cluster warning lights and gauges. After adjusting, push the steering wheel up and down to be in the locked position.

WARNING

Never adjust the steering wheel while driving. This may cause loss of vehicle control resulting in a collision.



To adjust:

1. Pull down the lock-release lever (1).
2. Adjust the steering wheel to the desired angle (2) and distance forward/back (3).

3. Pull the lock-release lever up to lock the steering wheel in place.

Information

Sometimes the lock-release lever may not engage completely. Pull down on the lock-release lever, readjust the steering wheel again, and then pull back up on the lock-release lever to lock the steering wheel in place.

Horn



To sound the horn, press the area indicated by the horn symbol on your steering wheel (see illustration). The horn operates only when this area is pressed.

NOTICE

Do not strike the horn severely or hit it with your fist. Do not press on the horn with a sharp-pointed object.

NOTICE

Do not clean the steering wheel surface with the following products:

- Organic solvents such as thinner, alcohol and gasoline
- Chemical products such as leather cleaner, coating agent, and wax

Mirrors

Inside rearview mirror

Before driving your vehicle, check to see that your inside rearview mirror is properly positioned. Adjust the rearview mirror so that the view through the rear window is properly centered.

WARNING

Make sure your line of sight is not obstructed. Do not place objects in the rear seat, cargo area, or behind the rear head restraints which could interfere with your vision through the rear window.

WARNING

To prevent serious injury during an accident or deployment of the air bag, do not modify the rearview mirror and do not install a wide mirror.

WARNING

Never adjust the mirror while driving. This may cause loss of vehicle control resulting in an accident.

NOTICE

When cleaning the mirror, use a paper towel or similar material dampened with glass cleaner. Do not spray glass cleaner directly on the mirror as this may cause the liquid cleaner to enter the mirror housing.

Day/night rearview mirror

 If equipped

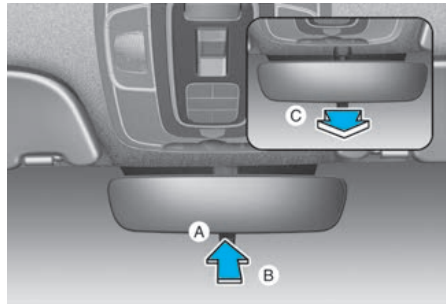

[A] Lever
[B] Day
[C] Night

Before driving at night, pull the day/night lever toward you to reduce glare from the headlights of the vehicles behind you.

Remember that you lose some rearview clarity in the night position.

Electrochromic mirror (ECM)

 If equipped



[A] Sensor

When the engine is running, the glare from vehicle headlights behind you is automatically controlled by the sensor mounted in the rearview mirror.

When the gear is shifted to R (Reverse), the mirror automatically goes to the brightest setting in order to improve the driver's view behind the vehicle

Electrochromic mirror (ECM) with HomeLink® system

+ if equipped

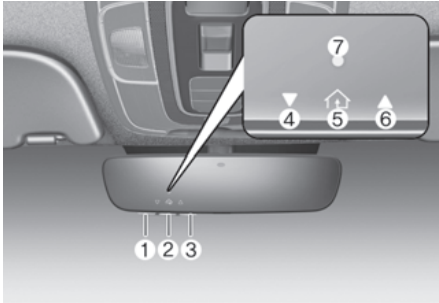

Your vehicle may be equipped with a Gentex Automatic-Dimming Mirror with an Integrated HomeLink® Wireless Control System.

During nighttime driving, this feature will automatically detect and help reduce rearview mirror glare. The HomeLink® Universal Transceiver allows you to activate your garage door(s), electric gate, home lighting, etc.

- (1) HomeLink Channel 1
- (2) HomeLink Channel 2
- (3) HomeLink Channel 3
- (4) Garage Door Opener Status Indicator : Closing or Closed
- (5) HomeLink Operation Indicator
- (6) Garage Door Opener Status Indicator : Opening or Opened
- (7) HomeLink User Interface Indicator

Automatic-Dimming Night Vision Safety™ (NVS®) Mirror

+ if equipped

The NVS® Mirror automatically helps reduce glare by monitoring light levels in the front and the rear of the vehicle. Any object that obstructs either light sensor will degrade the automatic dimming control feature.

For more information regarding NVS® mirrors and other applications, please refer to the Gentex website:

www.gentex.com

Your mirror will automatically dim upon detecting glare from the vehicles traveling behind you.

The mirror defaults to the ON position each time the vehicle is started.

Integrated HomeLink® Wireless Control System

The HomeLink® Wireless Control System can replace up to three hand-held radio-frequency (RF) transmitters with a single built-in device. This innovative feature will learn the radio frequency codes of most current transmitters to operate devices such as gate operators, garage door openers, entry door locks, security systems, even home lighting. Both standard and rolling code-equipped transmitters can be programmed by following the outlined procedures.

Additional HomeLink® information can be found at: www.homelink.com, www.youtube.com/HomeLinkGentex or by calling 1-800-355-3515.

Retain the original transmitter of the RF device you are programming for use in other vehicles as well as for future HomeLink® programming. It is also suggested that upon the sale of the vehicle, the programmed HomeLink® buttons be erased for security purposes.

WARNING

Before programming HomeLink® to a garage door opener or gate operator, make sure people and objects are out of the way of the device to prevent potential harm or damage. Do not use the HomeLink® with any garage door opener that lacks the safety stop and reverse features required by U.S. federal safety standards (this includes any garage door opener model manufactured before April 1, 1982). A garage door that cannot detect an object - signaling the door to stop and reverse - does not meet current U.S. federal safety standards. Using a garage door opener without these features increases the risk of serious injury or death.

Programming HomeLink®

Please note the following:

- When programming a garage door opener, it is advised to park the vehicle outside of the garage.
- It is recommended that a new battery be placed in the hand-held transmitter of the device being programmed to HomeLink® for quicker training and accurate transmission of the radio-frequency signal.
- Some vehicles may require the Engine Start/Stop button to be in the ACC (or "Accessories") position for programming and/or operation of HomeLink®.
- In the event that there are still programming difficulties or questions after following the programming steps listed below, contact HomeLink® at: www.homelink.com, www.youtube.com/HomeLinkGentex or by calling 1-800-355-3515.

Programming

To program most devices, follow these instructions:

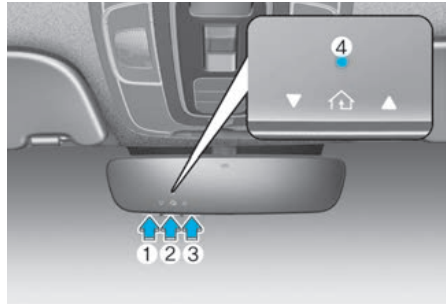

1. Press and release (1), (2) or (3) button.
 - If the indicator (4) is turned ON in Orange, go to Step 3) since it is a new programming.
 - If the indicator (4) is continuously turned ON or flashes in Green rapidly several times, go to Step 2) since it is a programmed button.
2. Press and hold the button you wish to program for approximately 15-25 seconds until the LED flashes in Orange for several times.
3. Hold the Garage Door Opener Original Transmitter near the HomeLink Mirror.



4. Press the Original Transmitter button until the indicator (4) is turned continuously ON or flashes in Green for approximately 10 seconds and it indicates the programming is completed.

5. However, the indicator (4) flashes in Green continuously, but if the garage door opener does not operate, please continue to follow the step 6 and 7 ("Rolling Code Programming" procedures).
6. Firmly press and release the "Learn," "Smart," or "Program" button while the indicator (4) flashes in Green. Once the button is pressed, you have approximately 30 seconds to initiate the next step.

i Information

At the garage door opener motor, (security gate motor, etc.) locate the "Learn," "Smart," or "Program" button. This can usually be found where the hanging antenna wire is attached to the motor-head unit (see the device's manual to identify this button). The name and color of the button may vary by manufacturer. A ladder and/or second person may simplify the following steps.

7. Return to the vehicle and firmly press, hold for two seconds and release the HomeLink button up to three times. Do not press the HomeLink button rapidly. At this point programming is complete and your device should operate when the HomeLink button is pressed and released.

i Information

- Some garage door openers require to press the programmed button on the mirror up to three times right after the programming is just completed to operate the garage door.
- The indicator (4) is turned ON in Orange and flashes for about 60 seconds, during the programming mode and if a programming is not succeeded within the 60 seconds, the programming mode will be abort.

HomeLink® should now activate your rolling code equipped device.

Gate operator & Canadian programming

During programming, your handheld transmitter may automatically stop transmitting. Continue to press the Integrated HomeLink® Wireless Control System button while you press and re-press ("cycle") your handheld transmitter every two seconds until the frequency signal has been learned. The indicator light will flash slowly and then rapidly after several seconds upon successful training.

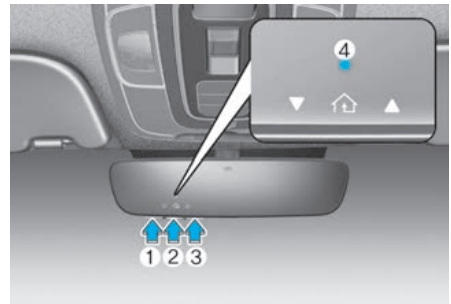

Operating HomeLink®

1. Press and release one of the HomeLink buttons (1, 2 or 3) that programmed.
2. The HomeLink indicator (4) will operate as below:
 - Indicates Green and is continuously ON (Fixed Code Garage Door Opener)
 - Flashes in Green rapidly (Rolling Code Garage Door Opener)

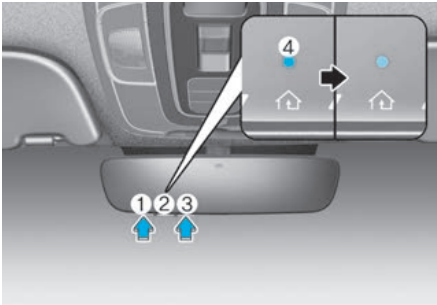

Erasing HomeLink® buttons

1. Press and hold the button (1) and (3) simultaneously.
2. The indicator (4) is turned continuously ON in orange for about 10 seconds.
3. Then the indicator (4) color changes to Green and flashes rapidly.
Release the buttons once the green indicator flashes.
4. Now HomeLink button (1), (2) and (4) memories are all cleared.

NVS® is a registered trademark and Z-Nav™ is a trademark of the Gentex Corporation, Zeeland, Michigan. HomeLink® is a registered trademark owned by Johnson Controls, Incorporated, Milwaukee, Wisconsin.

FCC ID: NZLUAHL5A

IC: 4112A-UAHL5A

i Information

This device complies with Part 15 of the FCC Rules.

Operation is subject to the following three conditions:

1. This device may not cause harmful interference, and
2. This device must accept any interference received, including interference that may cause undesired operation.
3. The transceiver has been tested and complies with FCC and Industry Canada rules. Changes or modifications not expressly approved by the party responsible for compliance could void the user's authority to operate the device.

Two Way Communication Programing

1. Complete the HomeLink "Programing" first.
2. Before the first 10 times HomeLink button is pressed after the programing, the following steps **MUST** occur to program two way communication. (only for some older garage doors)



3. Press and release the programed HomeLink button to activate the garage door.

4. Once the garage door is stopped, press and release the "Learn" or "Smart" button on the Garage door opener within 1 minute from the time of pressing the programmed HomeLink button on mirror.



5. If the both indicator (4) and (5) are flashing rapidly for about 5 seconds, the two way synchronization is completed.

i Information

Some newer garage door openers provide two-way communication synchronizing when programming the original transmitter.



Operating Two Way Communication

1. Press and release (1), (2) or (3) button.



2. The indicator (4) and (5) operates as below:

- If the indicator (4) flashes in Orange, it indicates that the garage door is "closing".
- If the indicator (4) is ON continuously in Green, it indicates that the garage door is "closed".
- If the indicator (5) flashes in Orange, it indicates that the garage door is "Opening".
 - If the indicator (5) is ON continuously in Green, it indicates that the garage door is "Opened".
 - If the indicator (4) or (5) does not turn to Green, it indicates that the last status of garage door was not received properly. The HomeLink mirror tries to receive the last known status of the garage door for a few seconds.

Recalling Garage Door Status

Homelink mirror with two way communication provides a way to view the last stored message from the garage door opener. In order to recall the last known status of the last activated device, press the buttons "1 and 2" OR "2 and 3" simultaneously.

- If the indicator (4) is ON continuously in Green, it indicates that the last activated device was "closed" properly.
- If the indicator (5) is ON continuously in Green, it indicates that the last activated device was "open" properly.

i Information

Two way communication range distance between "vehicle" and "garage door opener" is 100m.

The range may be reduced or increased a little due to obstacle conditions around the garage door opener, such as houses or trees.

Side view mirrors



Make sure to adjust the side view mirrors to your desired position before you begin driving.

Your vehicle is equipped with both left-hand and right-hand side view mirrors. The mirrors can be adjusted remotely with the remote switch. The side view mirrors can be folded to help prevent damage when going through an automatic car wash or when passing through a narrow street.

! WARNING

- The right side view mirror is convex. Objects seen in the mirror are closer than they appear.
 - Use the inside rear view mirror or look back directly to determine the actual distance of other vehicles prior to changing lanes.
 - Do not adjust or fold the side view mirrors while driving. This may cause loss of vehicle control resulting in an accident.
-

NOTICE

- Do not scrape ice off the mirror face; this may damage the surface of the glass.
- If the mirror is jammed with ice, do not adjust the mirror by force. Use an approved de-icer (not radiator antifreeze) spray, or a sponge or soft cloth with very warm water, or move the vehicle to a warm place and allow the ice to melt.

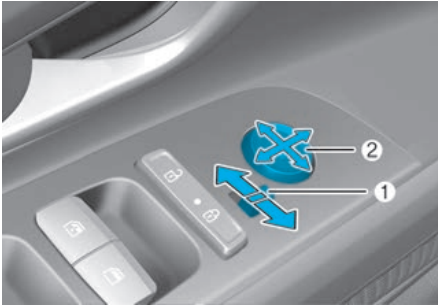
Side view mirror adjustment

1. Press either the L (left side) or R (right side) button (1) to select the side view mirror you would like to adjust.
2. Use the mirror adjustment control (2) to position the selected mirror up, down, left or right.

NOTICE

- The mirrors stop moving when they reach the maximum adjusting angles, but the motor continues to operate while the switch is pressed. Do not press the switch longer than necessary, because this can damage the motor.
- Do not attempt to adjust the side view mirrors by hand, because this can damage the motor.

Folding the side view mirrors

To fold the side view mirrors, grasp the housing of the mirror and then fold it inwards.

Windows

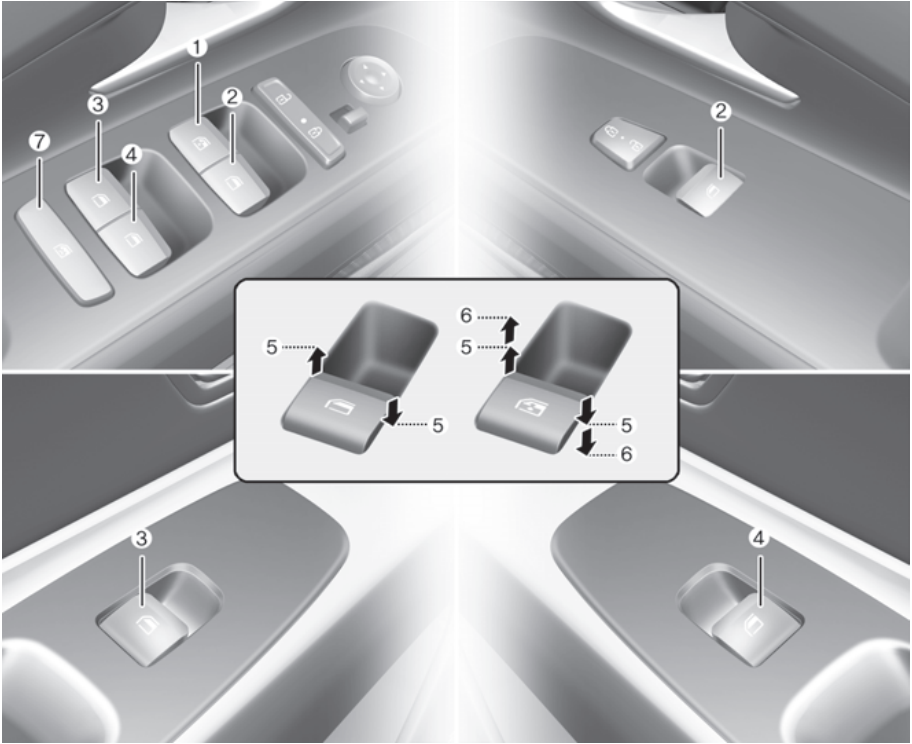

- (1) Driver's door power window switch
- (2) Front passenger's door power window switch
- (3) Rear door (left) power window switch
- (4) Rear door (right) power window switch
- (5) Window opening and closing
- (6) Automatic power window
- (7) Power window lock button

Power windows

The ignition switch must be in the ON position to be able to raise or lower the windows. Each door has a Power Window switch to control the door's window. The driver has a Power Window Lock button that can block the operation of rear passenger windows. The power windows will operate for about 3 minutes after the ignition is turned OFF or if the ignition is placed in the ACC position, as long as the front doors remain closed.

If the front doors are opened, the battery power is turned OFF and the Power Windows do not operate.

Window opening and closing

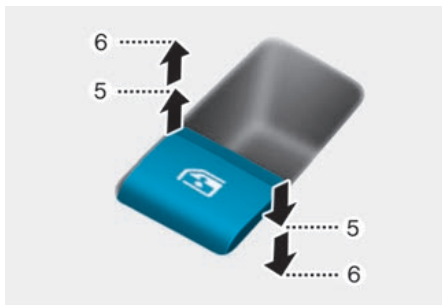

To open:

Press the window switch down to the first detent position (5). Release the switch when you want the window to stop.

To close:

Pull the window switch up to the first detent position (5). Release the window switch when you want the window to stop.

Auto down window

+ if equipped

Pressing the power window switch momentarily to the second detent position (6) completely lowers the window even when the switch is released.

To stop the window at the desired position while the window is operating, pull up or press down and release the switch.

Auto up/down window

+ if equipped

Pressing or pulling up the power window switch momentarily to the second detent position (6) completely lowers or lifts the window even when the switch is released. To stop the window at the desired position while the window is operating, pull up or press down and release the switch.

Resetting the power windows

If the power windows do not operate normally, the automatic power window system must be reset as follows:

1. Press the ignition switch to the ON position.
2. Close the window and continue pulling up on the power window switch for at least one second.

If the power windows do not operate properly after resetting, contact an authorized HYUNDAI dealer.

Automatic reversal

 if equipped

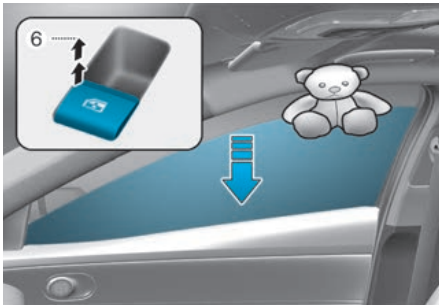

If a window senses any obstacle while it is closing automatically, it stops and lowers approximately 12 in. (30 cm) to allow the object to be cleared.

If the window detects any resistance while the power window switch is pulled up continuously, the window stops upward movement and then lowers approximately 1 in. (2.5 cm).

If the power window switch is pulled up continuously again within 5 seconds after the window is lowered by the automatic window reverse feature, the automatic window reverse does not operate.

Information

The automatic reverse feature is active only when the "Auto Up" feature is used by fully pulling up the switch to the second detent.

NOTICE

Do not install any accessories on the windows. The automatic reverse feature may not operate.

WARNING

Make sure body parts or other objects are safely out of the way before closing the windows to avoid injuries or vehicle damage.

Objects less than 0.16 in. (4 mm) in diameter caught between the window glass and the upper window channel may not be detected by the automatic reverse window and the window does not stop and reverse direction.

Power window lock button



The driver can disable the power window switches on the rear passenger doors by pressing the power window lock button. When the power window lock button is pressed:

- The driver's master control can operate all the power windows.
- The front passenger's control can operate the front passenger's power window.
- The rear passenger's control cannot operate the rear passengers' power window.

WARNING

Do not allow children to play with the power windows. Keep the driver's door power window lock button in the LOCK position. Serious injury or death may result from unintentional window operation by a child.

NOTICE

- To prevent possible damage to the power window system, do not open or close two windows or more at the same time. This also ensures the longevity of the fuse.
- Never try to operate the main switch on the driver's door and the individual door window switch in opposite directions at the same time. If this is done, the window stops and cannot be opened or closed.

Remote window opening function

 if equipped

Press and hold the Door Unlock () button on the smart key for more than 3 seconds and the front seat windows move down after the doors are unlocked. Window movement stops when you release the door unlock button.

NOTICE

Do not leave the windows down when leaving the vehicle to prevent theft or damage from water entering the vehicle.

Information

- The remote window opening function may abruptly stop, when you move away from your vehicle during operation. Stay in close proximity from your vehicle, while monitoring the window movement.
- The doors unlock when the windows are opened using the remote window opening function.

Sunroof

 if equipped

If your vehicle is equipped with a sunroof, you can slide or tilt your sunroof with the sunroof switch located on the overhead console.



The sunroof can be operated when the ignition switch is in the ON or START position.

The sunroof can also be operated for about 3 minutes after the ignition switch is in the ACC or LOCK/OFF position unless a front door is opened.

However, if the front door is open, the sunroof cannot be operated even within the 3 minute period.

WARNING

To prevent serious injury or death:

- Adjust the sunroof or sunshade when your vehicle stops.
- Do not leave the engine running and the key in your vehicle with unsupervised children. Unattended children may operate the sunroof.
- Do not sit on the top of the vehicle.

Sunshade



Use the sunshade to block direct sunlight coming through the sunroof glass.

Open or close the sunshade by hand.

i Information

The sunshade opens automatically when the sunroof glass is opened, but the sunshade does not close automatically when the sunroof glass is closed. Also, only the sunshade cannot be closed when the sunroof glass is opened.

NOTICE

Do not pull the sunshade up or down, or apply excessive force as such action may damage the sunshade or cause it to malfunction.

Tilt open/close

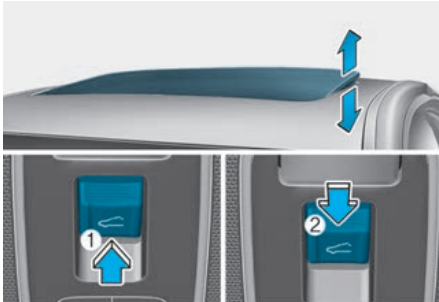

- (1) Tilt open
(2) Tilt close

- Push the sunroof switch up to tilt the sunroof glass open. If the sunshade is closed, open the sunshade manually first.
- Push the sunroof switch forward when the sunroof glass is tilt opened, the sunroof glass closes.

The sunroof glass tilts open or closes while the switch is pushed.

Slide open/close

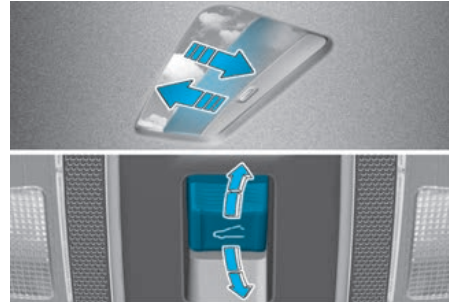

- Push the sunroof switch rearward. The sunroof glass slides open. If the sunshade is closed, the sunshade opens first and then the sunroof glass opens.
Push the sunroof switch forward. The sunroof glass closes.
Push the sunroof switch forward or rearward to the first detent position. The sunroof glass moves until the switch is released.
- Push the sunroof switch forward or rearward to the second detent position. The sunroof glass operates automatically (auto slide feature).
To stop the sunroof movement, push the sunroof switch in any direction.
- The sunroof glass stops halfway (first detent position) before it is fully opened. To fully open the sunroof glass, push the sunroof switch rearward once more. At this time, the sunroof glass opens only while the switch is pushed.

Automatic reversal

 If equipped

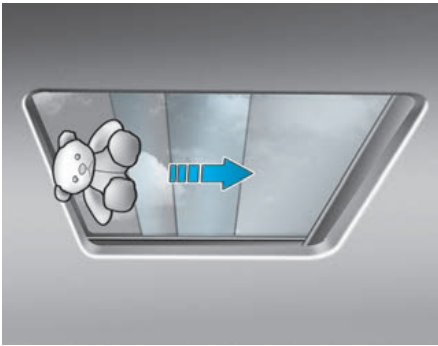

If the sunroof glass senses any obstruction while closing, it reverses direction then stops.

The automatic reverse feature may not work if a thin or soft object is caught between the sliding sunshade or sunroof glass and sunroof sash.

WARNING

- Make sure that heads, hands, arms, any other body parts, or objects are out of the way before operating the sunroof. Body parts or objects may get caught causing injuries or vehicle damage.
- Never deliberately use your body parts to test the automatic reverse feature.

NOTICE

- Do not continue to push the sunroof switch after the sunroof is fully opened, closed, or tilted. Damage to the sunroof motor may occur or may cause the motor or sunroof system to malfunction.
- Using the sunroof for a long time may make noise caused by dust accumulated between the sunroof and vehicle body. Open the sunroof and remove dust regularly using a clean cloth.
- Do not try to open the sunroof when the temperature is below freezing or when the sunroof is covered with snow or ice. Otherwise, the motor may be damaged. In a cold and wet weather, the sunroof may not work properly.
- Do not open or drive with the sunroof glass open immediately after rain or washing the vehicle. Water may wet the interior of the vehicle.
- Do not extend any cargo outside the sunroof while driving.

WARNING

Do not extend your head, arms, body parts or objects outside the sunroof while driving.

Resetting the sunroof



To reset the Sunroof:

1. Start the vehicle in P (Park).
2. Make sure the sunroof glass are in the fully closed position.
3. Release the switch when the sunroof glass are fully closed.
4. Push the switch forward until the sunroof glass move slightly. Then release the switch.
5. Push and hold the sunroof switch forward again until the sunroof glass slide open and close.

Do not release the switch until the operation is completed. If you release the switch, start again from Step 2.

i Information

If the sunroof does not reset after the vehicle battery is disconnected or discharged, or the sunroof fuse is blown, the sunroof may not operate normally.

Sunroof open warning

 if equipped

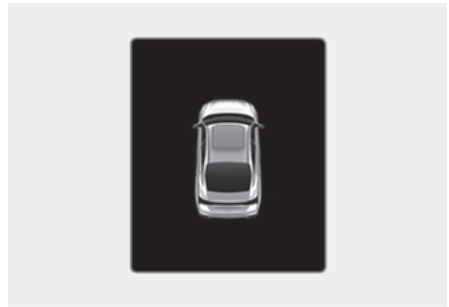

If the driver turns off the engine when the sunroof is not fully closed, the warning chime sounds for several seconds and the sunroof open warning appears on the cluster display.

Close the sunroof securely when leaving your vehicle.

NOTICE

Do not leave sunroof open when leaving the vehicle to prevent theft or damage from water entering the vehicle.

Hood

Opening the hood

1. Park the vehicle and apply the parking brake.
2. Pull the release lever to unlatch the hood. The hood pops open slightly.

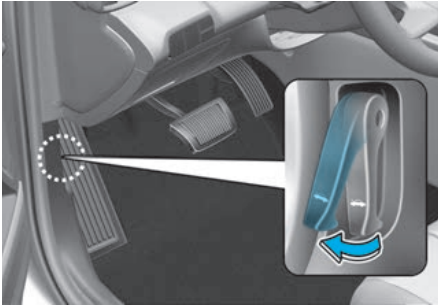

3. Go to the front of the vehicle, raise the hood slightly, push up the secondary hood release lever (1) inside of the hood center and lift the hood (2).

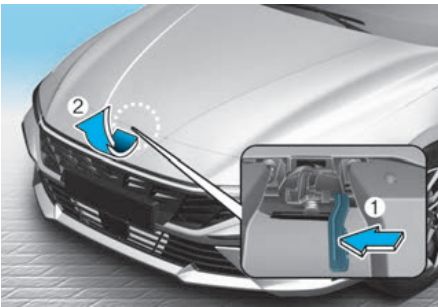

4. Lift the hood support rod.
5. Insert the end of the hood support rod into the slot located on the hood (3).



⚠ WARNING

- Grasp the hood support rod in the area wrapped in rubber when the engine is hot to protect you from burn or injury.
- Make sure that the end of the hood support rod is inserted fully into the hood slot to prevent the hood from falling.

Closing the hood

1. Before closing the hood, check in and around the engine compartment to ensure the following:
 - Any tools or other loose objects have been removed.
 - All glove, rags, or other combustible material have been removed.
 - All filler caps are tightly and correctly installed.
2. Return the hood support rod to its stored location.
3. Lower the hood until it is about 12 in. (30 cm) above the closed position and then let it drop.
4. Check the hood has locked properly. If the hood is raised slightly, open it again and drop it from a little higher. Check again.

WARNING

- Before closing the hood, ensure all obstructions are removed from around the hood opening.
- Always double check to make sure that the hood is firmly latched before driving away. Check there is no hood open warning light or message displayed on the instrument cluster. Driving with the hood open may cause a total loss of visibility, resulting in a collision.
- Do not move the vehicle with the hood raised. It may block your vision and may result in a collision.

Trunk

Opening the trunk

1. Make sure the shift lever is in P (Park) and set the parking brake.
2. Then do one of the following:
 - Hold down the trunk unlock button located on your remote key or smart key for more than 1 second.
 - Additionally, for vehicles equipped with smart key :
 - While all doors are unlocked, press the switch on the trunk to open the trunk with or without the smart key in your possession.
 - If any door is locked or all doors are locked, the switch can still be used to open the trunk, as long as the smart key is in your possession.

Outside



- Use the trunk release lever.

Inside



3. Lift the trunk lid up.

Closing the trunk

Lower the trunk lid and press down until it locks. Always check it is secure by pulling up the trunk lid.

i Information

To prevent damage to the trunk lift cylinders and the attached hardware, always close the trunk before driving.

NOTICE

Trunk lock and the trunk may not work if frozen shut due to moisture and freezing conditions.

Emergency trunk safety release



Your vehicle is equipped with an Emergency Trunk Safety Release lever located inside the trunk. When someone is inadvertently locked in the trunk, the trunk can be opened by moving the lever in the direction of the arrow and pushing the trunk open.

! WARNING

- You and your passengers must be aware of the location of the Emergency Trunk Safety Release lever in this vehicle and how to open the trunk in case you are accidentally locked in the trunk.
 - NEVER allow anyone to occupy the trunk of the vehicle at any time. If the trunk is partially or totally latched and the person is unable to get out, serious injury or death could occur due to lack of ventilation, exhaust fumes and rapid heat build-up, or because of exposure to cold weather conditions. The trunk is also a highly dangerous location in the event of a crash because it is not a protected occupant space but is a part of the vehicle's crush zone.
 - Your vehicle should be kept locked and the Smart Key should be kept out of the reach of children. Parents should teach their children about the dangers of playing in trunks.
 - Use the release lever for emergencies only.
-

Smart Trunk release

 if equipped

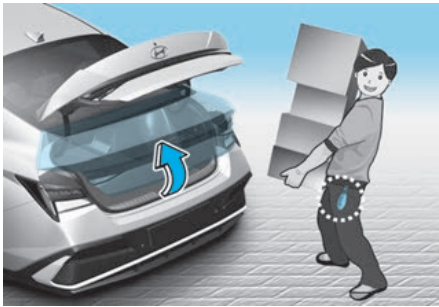

On a vehicle equipped with a smart key, the trunk can be opened using the Smart Trunk release system.

You can enable the Smart Trunk release system from the Settings menu in the instrument cluster.

Select: **User Settings > Doors > Smart Trunk**

How to use the Smart Trunk release

The trunk can be opened with no touch activation satisfying all the conditions below.

- After 15 seconds when all doors are closed and locked
- Positioned in the detecting area for more than 3 seconds

Information

The Smart Trunk release does not operate when:

- The smart key is detected within 15 seconds after the doors are closed and locked, and is continuously detected.
- The smart key is detected within 15 seconds after the doors are closed and locked, and 60 in. (1.5 m) from the front door handles. (for vehicles equipped with Welcome Light)
- A door is not locked or closed.
- The smart key is in the vehicle.

1. Setting

To activate the Smart Trunk release, go to User Settings Mode and select Smart Trunk on the cluster display.

For more information, refer to the "Cluster display (Type A)" section in chapter 4. If your vehicle is equipped with additional navigation, please refer to the infotainment system manual separately supplied.



2. Detect and Alert

If you are positioned in the detecting area (20-40 in. (50-100 cm) behind the vehicle) carrying a smart key, the hazard warning lights will blink and chime will sound to alert you the smart key has been detected and the trunk will open.

Information

Do not approach the detecting area if you do not want the trunk to open. If you have unintentionally entered the detecting area and the hazard warning lights and chime starts to operate, leave the detecting area with the smart key. The trunk will stay closed.

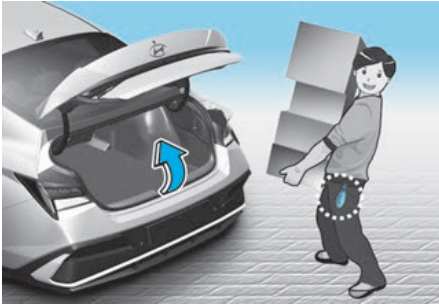

3. Automatic opening

The hazard warning lights will blink and chime will sound 6 times and then the trunk will open.

WARNING

- Make sure you close the trunk before driving your vehicle.
- Make sure there are no people or objects around the trunk before opening or closing the trunk.
- Make sure objects in the trunk do not come out when opening the trunk on a slope. It may cause serious injury.
- Make sure to deactivate the Smart Trunk when washing your vehicle. Otherwise, the trunk may open inadvertently.
- The key should be kept out of reach of children. Children may inadvertently open the Smart Trunk release while playing around the rear area of the vehicle.

How to deactivate the Smart Trunk release function using the smart key

Type A

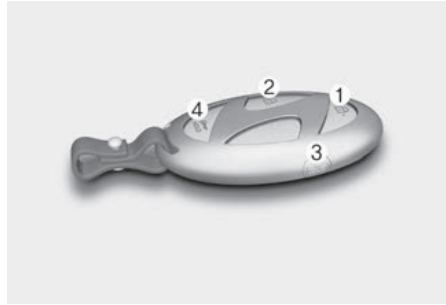

Type B

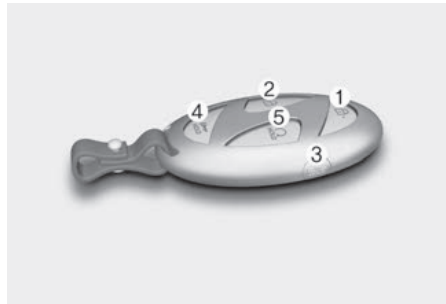

- (1) Door lock
- (2) Door unlock
- (3) Trunk open
- (4) Panic
- (5) Remote Start (if equipped)

If you press any button of the smart key during the Detect and Alert stage, the Smart Trunk release function will be deactivated.

Make sure to be aware of how to deactivate the Smart Trunk release function for emergency situations.

i Information

- If you press the door unlock button (2), the Smart Trunk release function will be deactivated temporarily. But, if you do not open any door for 30 seconds, the smart trunk function will be activated again.
- If you press the trunk open button (3) for more than 1 second, the trunk opens.
- If you press the door lock button (1) or trunk open button (3) when the Smart Trunk release function is not in the Detect and Alert stage, the smart trunk function will not be deactivated.
- In case you have deactivated the Smart Trunk function by pressing the smart key button and opened a door, the Smart Trunk release function can be activated again by closing and locking all doors.

Detecting area



- The Smart Trunk release operates with a welcome alert if the smart key is detected within 20-40 in. (50-100 cm) from the trunk.
- The alert stops at once if the smart key is positioned outside the detecting area during the Detect and Alert stage.

i Information

- The Smart Trunk release function will not work if any of the following occurs:
 - The smart key is close to a radio transmitter such as a radio station or an airport which can interfere with normal operation of the transmitter.
 - The smart key is near a mobile two way radio system or a cellular phone.
 - Another vehicle's smart key is being operated close to your vehicle.
- The detecting range may decrease or increase when :
 - One side of the tire is raised to replace a tire or to inspect the vehicle.
 - The vehicle is slantingly parked on a slope or unpaved road, etc.

Fuel filler door

Opening the fuel filler door



The fuel filler door must be opened from inside the vehicle by pulling up the fuel filler release lever.

1. Turn the engine off.
2. Pull up the fuel filler release lever.



3. Pull the fuel filler door (1) outward to access the fuel tank cap.
4. To remove the fuel tank cap (2), turn it counterclockwise. A hissing noise is heard because the pressure inside the tank equalizes.
5. Place the cap (3) on the fuel filler door (1).

i Information

If the fuel filler door does not open because ice has formed around it, tap lightly or push on the door to break the ice and release the door. Do not pry on the door. If necessary, spray around the door with an approved deicer fluid (do not use radiator anti-freeze) or move the vehicle to a warm place and allow the ice to melt.

Closing the fuel filler door

1. To install the fuel tank cap, turn it clockwise until it "Clicks".
2. Close the fuel filler door until it is latched securely.

! WARNING

Automotive fuel is highly flammable and explosive. Failure to follow these guidelines may result in serious injury or death:

- Read and follow all warnings posted at the gas station.
- Before refueling, note the location of the Emergency Gasoline Shut-Off, if available, at the gas station.
- Before touching the fuel nozzle, eliminate the potential build-up of static electricity by touching a metal part of the vehicle, a safe distance away from the fuel filler neck, nozzle, or other gas source, with your bare hand.
- Do not use cellular phones while refueling. Electric current and/or electronic interference from cellular phones may potentially ignite fuel vapors and cause a fire.
- Do not get back into a vehicle once you have begun refueling.

You can generate a build-up of static electricity by touching, rubbing, or sliding against any item or fabric capable of producing static electricity. Static electricity discharge may ignite fuel vapors causing a fire. If you must

re-enter the vehicle, once again eliminate potentially dangerous static electricity discharge by touching a metal part of the vehicle, away from the fuel filler neck, nozzle, or other gasoline source, with your bare hand.

- When refueling, always move the shift lever to the P (Park) position, apply the parking brake, and move the ignition switch to the LOCK/OFF position. Sparks produced by electrical components related to the engine can ignite fuel vapors causing a fire.
- When using an approved portable fuel container, be sure to place the container on the ground prior to refueling. Static electricity discharge from the container may ignite fuel vapors causing a fire. Once refueling has begun, contact between your bare hand and maintain the vehicle until the filling is complete.
- Use only approved portable plastic fuel containers designed to carry and store gasoline.
- Do not use matches or a lighter and do not smoke or leave a lit cigarette in your vehicle at a gas station, especially during refueling.
- Do not over-fill or top-off your vehicle tank, which may cause gasoline spillage.
- If a fire breaks out during refueling, get away from the vehicle, and immediately contact a gas station employee and then contact the local fire department.
- If pressurized fuel sprays out, it can cover your clothes or skin and increase the risk of fire and burns. If the cap is venting fuel or if you hear a hissing sound, wait until the condition stops before completely removing the cap.
- Always check that the fuel cap is installed securely to prevent fuel spillage in the event of a collision.

i Information

Make sure to refuel your vehicle according to the "Fuel requirements" suggested in chapter 9.

NOTICE

- Do not spill fuel on the exterior surfaces. It may damage the paint.
 - If the cap needs to be replaced, only use a genuine HYUNDAI cap or the fuel system or emission control system may malfunction.
-

Exterior lights

Lighting control

To operate the lights, turn the knob at the end of the control lever to one of the following positions:

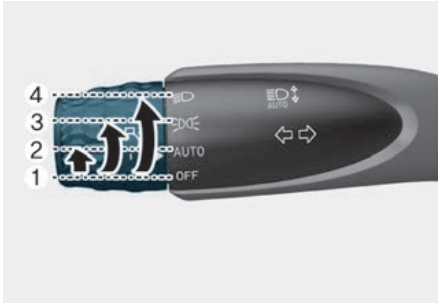

- (1) OFF
- (2) AUTO headlight
- (3) Parking light
- (4) Headlight

Daytime Running Lights (DRL)

The Daytime Running Lights can make it easier for others to see the front of your vehicle during the day, especially after dawn and before sunset. The DRL system is ON when the headlight switch is in the OFF or the AUTO headlight position and the Parking Brake is released.

It turns off when:

- The headlights are ON.
- The parking brake is applied.
- The vehicle is turned off.

AUTO headlight

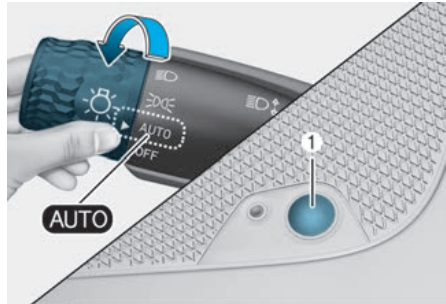

The headlights and parking lights are turned ON or OFF automatically depending on the amount of daylight as measured by the ambient light sensor (1) in front of the instrument panel.

Even with the AUTO headlight feature in operation, it is recommended to manually turn ON the headlights when driving at night or in a fog, driving in the rain, or when you enter dark areas, such as tunnels and parking facilities.

NOTICE

- Do not cover or spill anything on the sensor (1) located in front of the instrument panel.
- Do not clean the sensor using a window cleaner, the cleaner may leave a light film which could interfere with sensor operation.
- If your vehicle has window tint or other types of metallic coating on the front windshield, the AUTO headlight system may not work properly.

Parking light (☀)



The parking light, license plate light, and instrument panel light are turned ON.

Headlight (☀)



The headlight, parking light, license plate light, and instrument panel light are turned ON.

i Information

The ignition switch must be in the ON position to turn on the headlight.

High beam operation



To turn on the high beam headlight, push the lever away from you. The lever returns to its original position.

The high beam indicator illuminates when the headlight high beams are switched on.

To turn off the high beam headlight, pull the lever toward you. The low beams turn on.

⚠ WARNING

Do not use high beam when there are other vehicles approaching you. Using high beam may obstruct the other driver's vision.

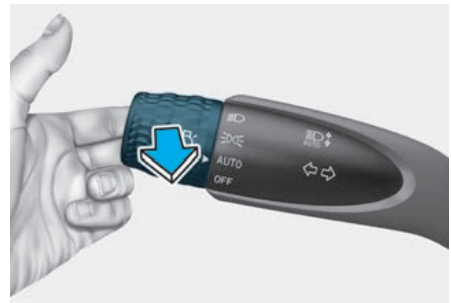

To flash the high beam headlight, pull the lever toward you, then release the lever. The high beams remain ON as long as you hold the lever.

Turn signals and lane change signals

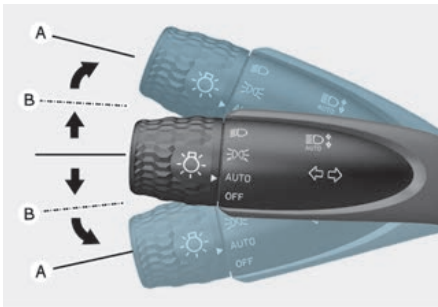

To signal a turn, push down on the lever for a left turn or up for a right turn in position (A).

If an indicator stays on and does not flash or if it flashes abnormally, one of the turn signal bulbs may be burned out and require replacement. Contact an authorized HYUNDAI dealer.

One touch turn signal

To use One Touch Turn Signal, push the turn signal lever up or down to position (B) and then release it.

The lane change signals blinks 3, 5 or 7 times.

You can enable the One Touch Turn Signal function or choose the number of blinking from the Settings menu in the instrument cluster or infotainment system.

Select:

- **User Settings > Lights > One Touch Turn Signal > Off/3 flashes/5 flashes/7 flashes** (for instrument cluster type)
- **Settings > Vehicle > Lights > One Touch Turn Signal > 3 flashes/5 flashes/7 flashes/Off** (for infotainment system type)

i Information

- For more information on the cluster type Settings menu, refer to the "Cluster display (Type A)" section in chapter 4.
- The infotainment system may change after software updates. For more information, refer to the user's manual provided in the infotainment system and the quick reference guide.

Battery saver function

To prevent the battery from being discharging, the system automatically turns off the parking lights when the driver turns the vehicle off and opens the driver's door.

To keep the lights on when the vehicle is turned off:

- (1) Open the driver's door.
- (2) Turn the parking lights OFF and ON again using the headlight switch.

Headlight delay function

 If equipped

If you place the ignition switch to the ACC or OFF position with the headlights ON, the headlights (and/or parking lights) remain on for about 5 minutes. If the driver's door is opened and closed, the headlights are turned off after 15 seconds. Also, with the vehicle off if the driver's door is opened and closed, the headlights (and/or parking lights) are turned off after 15 seconds.

The headlights (and/or parking lights) can be turned off by pressing the lock button on the remote key or smart key twice or turning the headlight switch to the OFF or AUTO position.

You can enable the headlight delay function from the Settings menu in the instrument cluster or infotainment system.

Select:

- **User Settings > Lights > Headlight Delay** (for instrument cluster type)
- **Settings > Vehicle > Lights > Headlight Delay** (for infotainment system type)

i Information

- For more information on the cluster type Settings menu, refer to the "Cluster display (Type A)" section in chapter 4.
- The infotainment system may change after software updates. For more information, refer to the user's manual provided in the infotainment system and the quick reference guide.

i Information

If the driver exits the vehicle through another door besides the driver's door, the battery saver function does not operate and the headlight delay function does not turn OFF automatically.

To avoid battery discharge, turn OFF the headlights manually before exiting the vehicle.

Interior lights

WARNING

Do not use the interior lights when driving in the dark. The interior lights may obscure your view and result in a collision. Do not use the interior lights for extended periods when the vehicle is turned off. Otherwise, the battery discharges.

Interior lights auto off

The interior lights automatically go off about 20 minutes after the vehicle is turned off and the doors are closed. If a door is opened, the light go off 40 minutes after the vehicle is turned off. If the doors are locked by the remote key or smart key and the vehicle enters the armed stage of the theft alarm system, the lights go off five seconds later.

Front lights



- (1) Map lamp
- (2) Door lamp
- (3) Room lamp ON
- (4) Room lamp OFF

Map lamp:

Press either lens to turn the map lamp on or off. This light produces a spot beam for convenient use as a map lamp at night or as a personal lamp for the driver and the front passenger.

Door lamp (☾):

The front or rear room lamps come on when the front or rear doors are opened. When doors are unlocked by the remote key or smart key, the front and rear lamps come on for about 30 seconds as long as any door is not opened. The front and rear room lamps go out gradually after about 30 seconds if the door is closed. However, if the ignition switch is in the ON position or all doors are locked, the front and rear lamps will turn off. If a door is opened with the ignition switch in the ACC or LOCK/OFF position, the front and rear lamps stay on for about 10 minutes.

Room lamp:

- ☾ :
Press the button to turn ON the room lamp for the front/rear seats.
- ☾ :
Press the button to turn OFF the room lamp for the front/rear seats.

Mood lamp

 if equipped

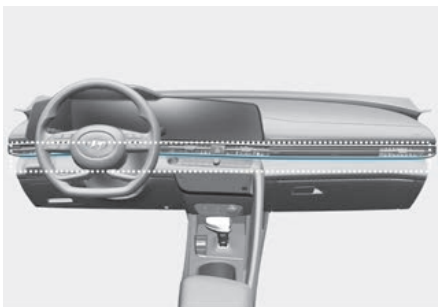

The lamp turns on when **'Settings > Vehicle > Lights > Ambient Light'** is selected from the infotainment system.

Rear room lamp

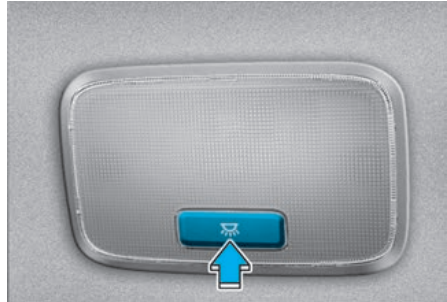

Press this button to turn the room lamp on or off.

Vanity mirror lamp

 if equipped

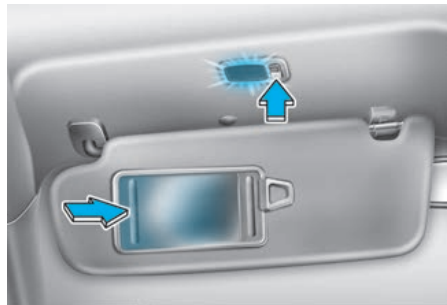

Push the switch to turn the light on or off.

- ☾ : The lamp turns on if this button is pressed.
- : The lamp turns off if this button is pressed.

Luggage compartment lamp



The luggage compartment lamp comes on when the trunk is opened and off when the trunk is closed.

Welcome system

+ if equipped



Welcome system helps keep the driver visible by turning on vehicle lights when the driver approaches the vehicle.

Door handle light

+ if equipped

When all the doors (and trunk) are closed and locked, the door handle light turns on for about 15 seconds if:

- The door lock button is pressed on the smart key.
- The button of the outside door handle is pressed while carrying the smart key.

You can activate or deactivate the Welcome Light function from the User Settings menu in the instrument cluster.

i Information

For more information on the cluster type Settings menu, refer to the "Cluster display (Type A)" section in chapter 4.

Headlight and parking light

When the headlight switch is in the headlight or AUTO position and all doors (and trunk) are locked and closed, the parking lights and headlights come on for 15 seconds when the door unlock button is pressed on the remote key or smart key. If you press the door lock or unlock button again, the parking lights and headlights turn off immediately.

Interior light

When the interior light switch is in the  position and all doors (and trunk) are closed and locked, the room lamps come on for 30 seconds when:

- The door unlock button is pressed on the remote key or smart key.
- The button of the outside door handle is pressed while carrying the smart key.
- You put your hand in the outside door handle while carrying the smart key.

If you press the door lock or unlock button on the smart key, the lights turn off immediately.

High Beam Assist (HBA)

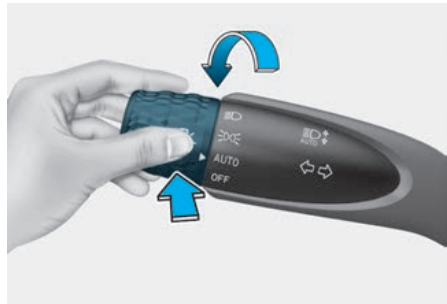

High Beam Assist automatically adjusts the headlights between high beam and low beam depending on the light detected from oncoming vehicles or vehicles in front using the front view camera.

Information

Refer to the "Driver assistance system sensors" section in chapter 7 for the location and the general precautions of front view camera.

High Beam Assist settings

With the ignition switch ON, go to the User Settings menu to turn on High Beam Assist and deselect to turn off the function in the instrument cluster.



Select:

User Settings > Lights > High Beam Assist (for cluster type)

WARNING

Only change the settings after parking your vehicle at a safe location.

High Beam Assist operation

- After selecting **High Beam Assist** from the settings menu to operate High Beam Assist:
 - Place the headlight switch in the AUTO position and push the turn signal lever toward the instrument cluster. High Beam Assist () indicator light illuminates.
 - When High Beam Assist is enabled, high beams turn on when the vehicle speed is above 20 mph (30 km/h) and the High Beam () indicator light illuminates. When the vehicle speed is below 12 mph (20 km/h), high beams do not turn on and the indicator light illuminates in white.
- When High Beam Assist is operating:
 - If the turn signal lever is pulled toward you when the high beams are off, the high beams turn on. When you let go of the turn signal lever, High Beam Assist operates again.
 - If the turn signal lever is pulled toward you when the high beams are on by High Beam Assist, the low beams turn on and High Beam Assist turns off.
 - If the turn signal lever is pushed away from you, the high beams turn on and High Beam Assist turns off.
 - If the headlight switch is moved from AUTO to another position (headlight/position/off), the corresponding light turns on and High Beam Assist turns off.

- When High Beam Assist is operating, high beam switches to low beam if:
 - The headlights of an oncoming vehicle are detected.
 - The tail lights of a front vehicle are detected.
 - The headlight or tail light of a motorcycle or a bicycle is detected.
 - The surrounding ambient light is bright enough so high beams are not required.
 - Streetlights or other lights are detected.

Information

The images and colors in the instrument cluster may differ depending on the cluster type or theme selected from the settings menu.

High Beam Assist malfunction and limitations

System malfunction

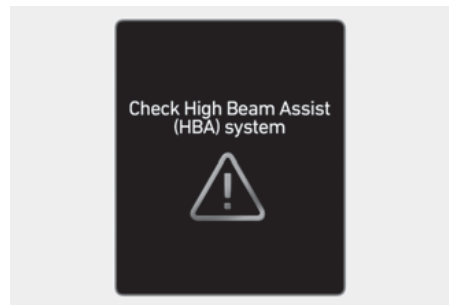

When High Beam Assist is not working properly, the "**Check High Beam Assist (HBA) system**" warning message may appear, and the  warning light may illuminate on the instrument cluster. Contact an authorized HYUNDAI dealer.

Limitations of High Beam Assist

High Beam Assist may not work properly in the following situations if:

- The headlights from an oncoming or front vehicle is damaged or out of the detection range.
- The headlights from an oncoming or front vehicle are covered with dust, snow, or water.
- An oncoming or front vehicle's headlights are off but the fog lamps are on.
- There are lights that have a similar shape as a vehicle's light ahead.
- The headlights are not repaired or replaced properly.
- The headlights are not aimed properly.
- You are driving on a narrow curved road, rough road, uphill, or downhill.
- A front vehicle is partially visible at a crossroad or on a curved road.
- There is a temporary reflector or flash ahead (construction area).
- There is a traffic light, reflecting sign, LED sign, or reflectors ahead.
- The road is wet or covered with snow or ice.
- A vehicle suddenly appears from a curve.
- The vehicle is tilted due to a flat tire or being towed.
- The headlights from an oncoming or front vehicle is not detected because of exhaust fumes, smoke, fog, snow, blizzard, water spray on the road, or windshield condensation, etc.

i Information

For more information on the limitations of the front view camera, refer to the "Forward Collision Avoidance Assist (FCA) (Sensor fusion)" section in chapter 7.

⚠ WARNING

- Always check road conditions, and if necessary, take appropriate actions to drive safely. It is your responsibility to operate your vehicle in a safe manner.
 - If High Beam Assist does not operate properly, use the turn signal lever to switch between high beam and low beam.
 - High Beam Assist may not operate for 15 seconds right after your vehicle is started or when the front view camera is initialized.
-

Wipers and washers

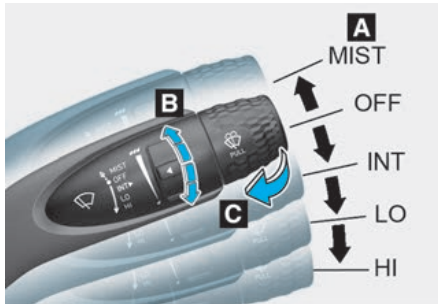

A. Wiper speed control

- MIST - Single wipe
- OFF - Off
- INT - Intermittent wipe
- LO - Low wiper speed
- HI - High wiper speed

B. Intermittent control wipe time adjustment

C. Wash with brief wipes (pull lever towards you)

Windshield wipers

Operates as follows when the ignition switch is turned ON.

MIST: For a single wiping cycle, move the lever up (MIST) and release it. The wipers operate continuously if the lever is held in this position.

OFF: Wipers are not in operation.

INT: Wipers operate intermittently at the same wiping intervals. Use this mode in light rain or mist. To change the speed setting, turn the speed control knob.

LO: The wiper runs at a lower speed.

HI: The wiper runs at a higher speed.

i Information

If there is heavy accumulation of snow or ice on the windshield, defrost the windshield for about 10 minutes, or until the snow and/or ice is removed to prevent damage to the wiper and washer system.

Front windshield washers



In the OFF position, pull the lever gently toward you to spray washer fluid on the windshield and to run the wipers 1-3 cycles. The spray and wiper operation continues until you release the lever. If the washer does not work, you may need to add washer fluid to the washer fluid reservoir.

WARNING

When the outside temperature is below freezing, always warm the windshield using the defroster to prevent the washer fluid from freezing on the windshield and obscuring your vision that could lead to a collision resulting in serious injury or death.

Always use appropriate washer fluids in the winter season or cold weather.

NOTICE

To prevent damage:

- Do not operate the washer when the fluid reservoir is empty or when the windshield is dry.
- Do not attempt to move the wipers manually.

Manual climate control system

+ if equipped

Type A





Type B



- (1) Fan speed control knob
- (2) Temperature control knob
- (3) Mode selection knob
- (4) Front windshield defroster position
- (5) Rear window/side view mirror defroster (if equipped) button
- (6) Air intake control button
- (7) A/C (Air conditioning) button

Heating and air conditioning

1. Start the engine.
2. Set the mode to the desired position.
To improve the effectiveness of heating and cooling, select:

- Heating: 
- Cooling: 

3. Set the temperature control to the desired position.
4. Set the air intake control to outside (fresh) air or recirculated air position.
5. Set the fan speed control to the desired speed.
6. If air conditioning is desired, turn on the air conditioning system.

When starting the vehicle in cold weather a more efficient way to heat the passenger compartment is to do the following.

- Turn off or lower the blower, right after starting the engine.
 - Engine temperature is still low and the air flow from the heater is still cold.
- After a few minutes of engine warm up, turn on or set the fan to a higher level and adjust the temperature setting towards hot.

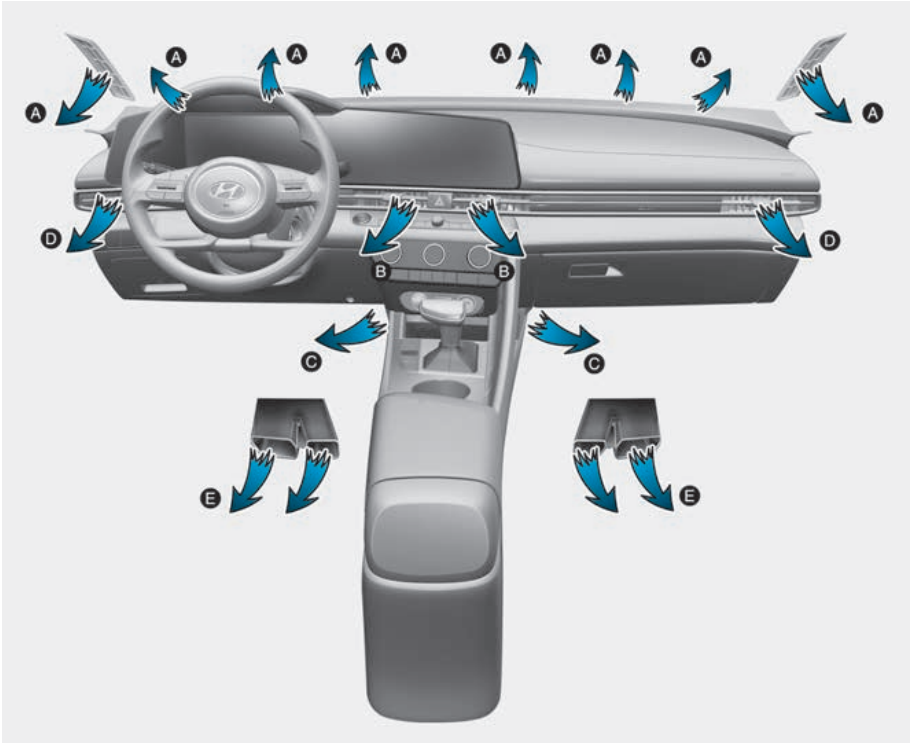
Mode selection



The mode selection knob controls the direction of the air flow through the ventilation system.

Air can be directed to the floor, dashboard outlets, or windshield. Five symbols are used to represent Face, Bi-Level, Floor, Floor-Defrost and Defrost air position.

Face-Level (B, D)



Air flow is directed toward the upper body and face. Additionally, each outlet can be controlled to direct the air discharged from the outlet.

Bi-Level (B, C, D, E)



Air flow is directed toward the face and the floor.

Floor-Level (C, E)



Most of the air flow is directed to the floor, with a small amount of the air being directed to the windshield and side window defrosters.

Floor & Defrost (A, C, D, E)



Most of the air flow is directed to the floor and the windshield with a small amount directed to the side window defrosters.

Defrost-Level (A, D)



Most of the air flow is directed to the windshield with a small amount of air directed to the side window defrosters.

MAX A/C-Level (B, D)

 if equipped



The MAX A/C mode is used to cool the inside of the vehicle faster.

Air flow is directed toward the upper body and face.

The air conditioning and recirculated air are both selected. Turn the fan speed mode to adjust.

Instrument panel vents

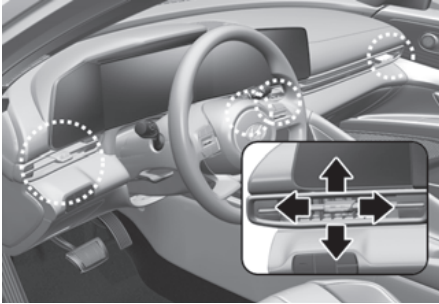

The instrument panel vent air flow can be directed up/down or left/right using the vent adjustment lever.

To close the vent, push the air vent lever in the opposite direction of the passenger. To open the vent, push the air vent lever in the same direction of the passenger.

Temperature control

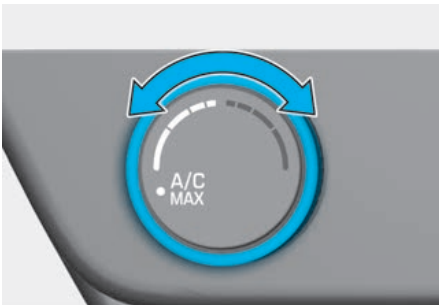

The temperature increases by turning the knob to the right.

The temperature decreases by turning the knob to the left.

Air intake control

Type A



Type B

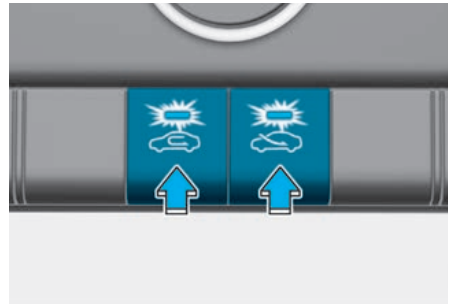

To select outside (fresh) air or recirculated air, press this button.

Recirculated air position



With the recirculated air selected, air from the passenger compartment is drawn through the climate control system.

Outside (fresh) air position

Type A



Type B



With the outside (fresh) air selected, air enters the vehicle from outside and is drawn through the climate control system.

i Information

Using the system in the fresh air position is recommended.

Prolonged operation of the heater in the recirculated air position (without air conditioning selected) can cause fogging of the windshield and side windows and the air within the passenger compartment will become stale.

In addition, prolonged use of the air conditioning with the recirculated air position selected will result in excessively dry air in the passenger compartment.

WARNING

To prevent serious injury or death:

- Continued climate control system operation in the recirculated air position may allow humidity to increase inside the vehicle that could fog the windshield and the side windows and obscure visibility.
- Do not sleep in a vehicle with the air conditioning or heating system on.
- Continued climate use of recirculated air may cause drowsiness or sleepiness, and loss of vehicle control. Set the air intake control to the outside (fresh) air position while driving.

Fan speed control



Turn the knob to the right to increase the fan speed and airflow. Turn the knob to the left to decrease fan speed and airflow. Setting the fan speed control knob to the "0" position turns off the fan.

NOTICE

Operating the fan speed when the ignition switch is in the ON position may cause the battery to discharge. Operate the fan speed when the engine is running.

Air conditioning (A/C)

⁺if equipped



Press the A/C button to turn the air conditioning system on (indicator light will illuminate). Press the button again to turn the air conditioning system off.



System operation

Ventilation

1. Select the Face Level  mode.
2. Set the air intake control to the outside (fresh) air position.
3. Set the temperature control to the desired position.
4. Set the fan speed control to the desired speed.

Heating

1. Select the Floor Level  mode.
2. Set the air intake control to the outside (fresh) air position.
3. Set the temperature control to the desired position.
4. Set the fan speed control to the desired speed.
5. If desired, turn the air conditioning ON with the temperature control knob set to heat in order to dehumidify the air before it enters into the cabin.

If the windshield fogs up, select the Floor & Defrost  mode or rotate the mode selecting knob to the Defrost  mode.

Operation Tips

- To help keep dust or unpleasant fumes from entering the vehicle through the ventilation system, temporarily set the air intake control to the recirculation mode. Be sure to return the control to fresh mode position when the irritation has passed to keep fresh air in the vehicle. This can help keep the driver alert and comfortable.
- To help prevent interior fog on the windshield, set the air intake control to the fresh air position and the fan speed to the desired position, turn on the air conditioning system, and adjust the temperature control to desired temperature.

Air conditioning

1. Start the engine. Press the air conditioning button.
2. Select the Face Level  mode.
3. Set the air intake control to the outside air or recirculated air position.
4. Adjust the fan speed control and temperature control as desired.

NOTICE

- When using the air conditioning system, monitor the temperature gauge closely while driving up hills or in heavy traffic when outside temperatures are high. Continue to use the fan but turn off the air conditioning system if the temperature gauge indicates the engine is overheating.
- Always use the air conditioning with the windows closed. In humid weather, if the windows are open and the air conditioning is running, water droplets may form inside the vehicle and potentially damage electrical equipment.

Air conditioning system operation tips

- If the vehicle has been parked in direct sunlight during hot weather, open the windows for a short time to let the hot air inside the vehicle escape.
- After sufficient cooling has been achieved, switch back from recirculated air position to the fresh outside air position.
- To help reduce moisture inside of the windows on rainy or humid days, decrease the humidity inside the vehicle by operating the air conditioning system with the windows and sunroof closed.
- During air conditioning system operation, you may occasionally notice a slight change in engine speed as the air conditioning compressor cycles. This is a normal system operation characteristic.
- Use the air conditioning system every month only for a few minutes to ensure maximum system performance.
- When using the air conditioning system, you may notice clear water dripping (or even puddling) on the ground under the passenger side of the vehicle. This is a normal system operation characteristic.
- If you operate the air conditioner excessively, the difference between the temperature of the outside air and that of the windshield may cause the outer surface of the windshield to fog up, causing loss of visibility. In this case, set the mode selection button to the  position and set the fan speed control knob to the lowest speed setting.

System maintenance

Cabin air filter

i Information

- Replace the filter according to the Maintenance Schedule.
- If the car is being driven in severe conditions such as dusty, rough roads, more frequent cabin air filter inspections and changes are required.
- When the air flow rate suddenly decreases, have the system inspected by an authorized HYUNDAI dealer.

Checking the amount of air conditioner refrigerant and compressor lubricant

If the amount of refrigerant is too low or too high, the performance of the air conditioning is reduced.

Have the system inspected by an authorized HYUNDAI dealer.

NOTICE

It is important that the correct type and amount of oil and refrigerant are used. Otherwise, damage to the compressor and abnormal system operation may occur. To prevent damage, the air conditioning system in your vehicle should only be serviced by trained and certified technicians.

NOTICE

- The refrigerant system should only be serviced by trained and certified technicians in a well-ventilated area to ensure proper and safe operation.
- Never repair the air conditioning evaporator (cooling coil) or replace with the one removed from a used or salvaged vehicle. A new replacement evaporator must be certified (and labeled) as meeting SAE Standard J2842.

WARNING



To prevent serious injury, have the air conditioning system be serviced by only trained and certified technicians. R-1234yf is flammable and operated at high pressure.

Reclaim all refrigerants with proper equipment. Venting refrigerants directly to the atmosphere is harmful to individuals and environment.

Air conditioning refrigerant label



You can find out which air conditioning refrigerant is applied to your vehicle on the label located inside of the hood.

Example

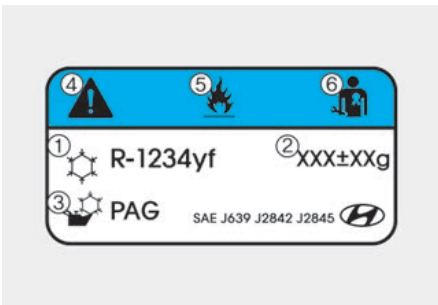

Each symbols and specification on the air conditioning refrigerant label is represented as the following:

1. Classification of refrigerant
2. Amount of refrigerant
3. Classification of Compressor lubricant
4. Caution
5. Flammable refrigerant
6. To require registered technician to service air conditioning system

Automatic climate control system

 if equipped

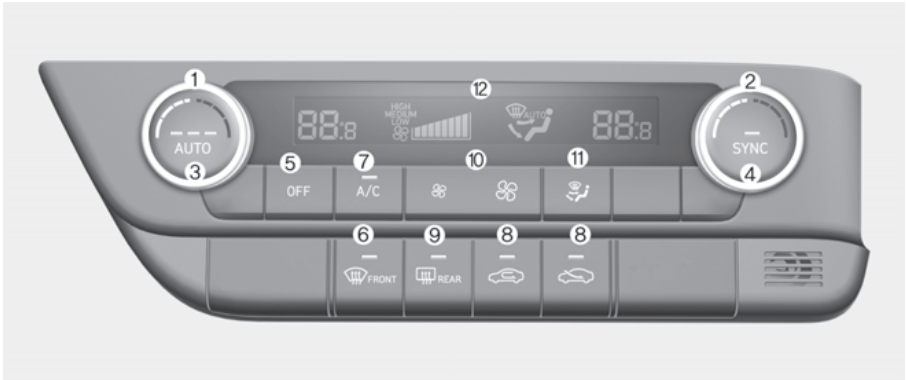

- (1) Driver's temperature control knob
- (2) Passenger's temperature control knob
- (3) AUTO (automatic control) button
- (4) SYNC button
- (5) OFF button
- (6) Front windshield defroster button
- (7) Air conditioning button
- (8) Air intake control button
- (9) Rear window/side view mirror (if equipped) defroster button
- (10) Fan speed control button
- (11) Mode selection button
- (12) Climate control information screen

Automatic heating and air conditioning

The Automatic Climate Control System is controlled by setting the desired temperature.

1. Press the AUTO button

The modes, fan speeds, air intake, and air conditioning are controlled automatically by the temperature setting.

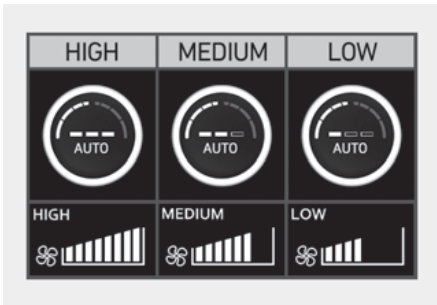

You can control the blower strength in three stages by pressing the AUTO button during automatic operation.

- **HIGH:** Provides rapid air conditioning and heating with the maximum fan speed setting.
- **MEDIUM:** Provides air conditioning and heating with the mid-level fan speed setting.
- **LOW:** Fan speed is set to the lowest setting range (1 to 3 bars range).

2. Turn the temperature control knob to set the desired temperature. If the temperature is set to the lowest setting (Lo), the air conditioning system operates continuously.

After the interior has cooled sufficiently, adjust the knob to a higher temperature set point whenever possible.

- To turn the automatic operation off, select any button of the following buttons:
 - Mode selection button
 - Front windshield defroster button (Press the button one more time to deselect the front windshield defroster function. The "AUTO" sign illuminates on the information screen once again.)
 - Fan speed control toggle switchThe selected function is controlled manually while other functions operate automatically.
- For your convenience and overall system efficiency, use the AUTO button and set the temperature to 72 °F (22 °C).

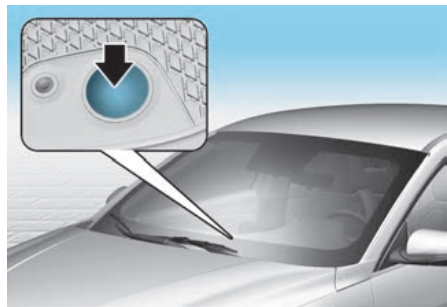

i Information



Never place anything near the sensor to ensure better control of the heating and cooling system.

Manual heating and air conditioning

The heating and cooling system can be controlled manually by pushing buttons other than the AUTO button. In this case, the system works sequentially according to the order of buttons selected. When pressing any button except the AUTO button while using automatic operation, the functions not selected is controlled automatically.

1. Start the engine.
2. Set the mode to the desired position.
To improve the effectiveness of heating and cooling, select:
 - Heating: 
 - Cooling: 
3. Set the temperature control to the desired position.
4. Set the air intake control to the outside (fresh) air position.
5. Set the fan speed control to the desired speed.
6. If air conditioning is desired, turn the air conditioning system on.
7. Press the AUTO button in order to convert to full automatic control of the system.

Mode selection

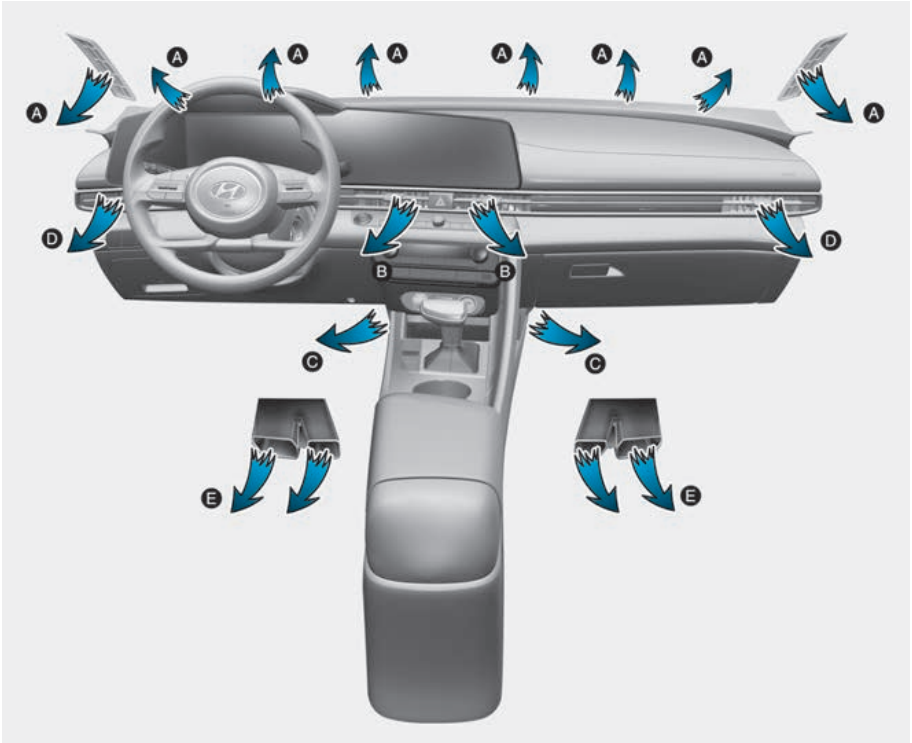



The mode selection button controls the direction of the air flow through the ventilation system.

The air flow outlet direction is cycled as follows:



Face-Level (B, D)



Air flow is directed toward the upper body and face. Additionally, each outlet can be controlled to direct the air discharged from the outlet.

Bi-Level (B, C, D, E)



Air flow is directed toward the face and the floor.

Floor-Level (C, E)



Most of the air flow is directed to the floor, with a small amount of the air being directed to the windshield and side window defrosters.

Floor & Defrost (A, C, D, E)



Most of the air flow is directed to the floor and the windshield with a small amount directed to the side window defrosters.

Defrost-Level (A, D)

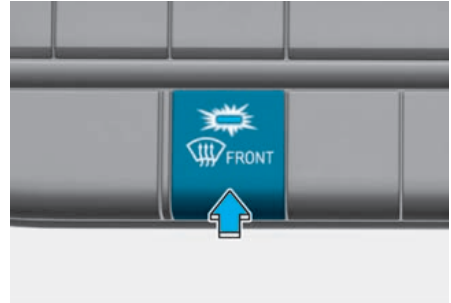

Most of the air flow is directed to the windshield with a small amount of air directed to the side window defrosters.

Instrument panel vents

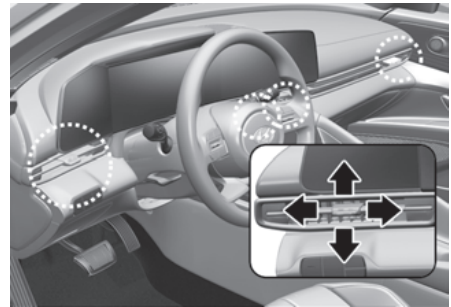

The instrument panel vent air flow can be directed up/down or left/right using the vent adjustment lever.

To close the vent, push the air vent lever in the opposite direction of the passenger. To open the vent, push the air vent lever in the same direction of the passenger.

Temperature control

Driver's seat

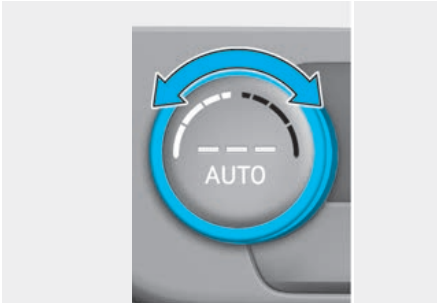

Passenger's seat



The temperature will increase by turning the knob to the right.

The temperature will decrease by turning the knob to the left.

Adjusting the temperature equally



- Press the SYNC button (indicator light ON) to adjust the driver and passenger side temperature equally.
- Turn the driver side temperature control knob. The driver and passenger side temperature is adjusted equally.
- If you rotate the passenger's temperature control knob, the passenger side temperature can be operated individually.

Adjusting the temperature individually

Press the SYNC button (indicator light OFF) again to adjust the driver and passenger side temperature individually.

Temperature conversion

If the battery has been discharged or disconnected, the temperature mode display is reset to Celsius.

To change the temperature unit from °C to °F or °F to °C:

- Automatic climate control system
Press the AUTO button for 3 seconds while pressing the OFF button.
- Instrument cluster or infotainment system screen, select:
 - **User Settings > Unit > Temperature Unit > °F/°C** (for instrument cluster type)
 - **Settings > General > Unit > Temperature Unit > °F/°C** (for infotainment system type)

The temperature unit on both the cluster display and the climate control screen will change.

i Information

- For more information on the cluster type Settings menu, refer to the "Cluster display (Type A)" section in chapter 4.
- The infotainment system may change after software updates. For more information, refer to the user's manual provided in the infotainment system and the quick reference guide.

Air intake control

Recirculated air position



With the recirculated air position selected, air from the passenger compartment will be drawn through the climate control system.

Outside (fresh) air position



With the outside (fresh) air position selected, air enters the vehicle from outside and is drawn through the climate control system.

i Information

Using the system in the fresh air position is recommended.

Prolonged operation of the heater in the recirculated air position (without air conditioning selected) can cause fogging of the windshield and side windows and the air within the passenger compartment will become stale.

In addition, prolonged use of the air conditioning with the recirculated air position selected will result in excessively dry air in the passenger compartment.

WARNING

To prevent serious injury or death:

- Continued climate control system operation in the recirculated air position may allow humidity to increase inside the vehicle that could fog the windshield and the side windows and obscure visibility.
- Do not sleep in a vehicle with the air conditioning or heating system on.
- Continued climate use of recirculated air may cause drowsiness or sleepiness, and loss of vehicle control. Set the air intake control to the outside (fresh) air position while driving.

Fan speed control

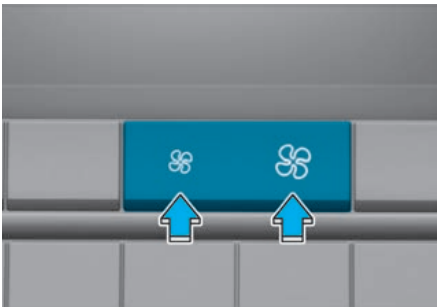

The fan speed can be adjusted as desired by pressing the fan speed control button.

NOTICE

Operating the fan speed when the ignition switch is in the ON position may cause the battery to discharge.

Air conditioning

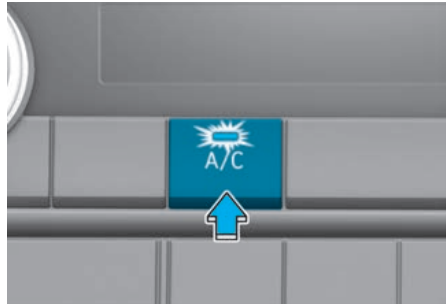

Press the A/C button to turn on the air conditioning system (indicator light ON). Press the button again to turn off the air conditioning system.

OFF mode

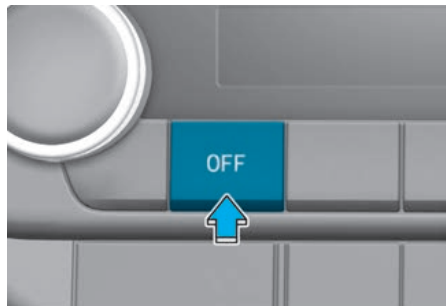

Press the OFF button to turn off the climate control system.

You can still operate the mode buttons and air intake buttons as long as the ignition switch is in the ON position.



System operation

Ventilation

1. Select the Face Level  mode.
2. Set the air intake control to the outside (fresh) air position.
3. Set the temperature control to the desired position.
4. Set the fan speed control to the desired speed.

Heating

1. Select the Floor Level  mode.
2. Set the air intake control to the outside (fresh) air position.
3. Set the temperature control to the desired position.
4. Set the fan speed control to the desired speed.
5. If desired, turn the air conditioning ON with the temperature control knob set to heat in order to dehumidify the air before it enters into the cabin.

If the windshield fogs up, select the Front & Defrost  mode or press the Front Defrost  mode.

Operation Tips

- When starting the vehicle in cold weather a more efficient way to heat the passenger compartment is to do the following:
 - Turn off or lower the blower right after starting the engine.
 - If the engine temperature is still low and the air flow from the heater is still cold, after a few minutes of engine warm up, turn on or set the fan speed to a higher level and adjust the temperature setting to hot.

- To help keep dust or unpleasant fumes from entering the vehicle through the ventilation system, temporarily set the air intake control to the recirculation mode. Be sure to return the control to fresh mode position when the irritation has passed to keep fresh air in the vehicle. This can help keep the driver alert and comfortable.
- To help prevent interior fog on the windshield, set the air intake control to the fresh air position and the fan speed to the desired position, turn on the air conditioning system, and adjust the temperature control to desired temperature.

Air conditioning

HYUNDAI Air Conditioning Systems are filled with R-1234yf refrigerant.

1. Start the engine. Press the air conditioning button.
2. Select the Face Level  mode.
3. Set the air intake control to the outside air or recirculated air position.
4. Adjust the fan speed control and temperature control as desired.

NOTICE

When using the air conditioning system, monitor the temperature gauge closely while driving up hills or in heavy traffic when outside temperatures are high. Air conditioning system operation may cause engine overheating. Continue to use the blower fan but turn the air conditioning system off if the temperature gauge indicates engine overheating.

Air conditioning system operation tips

- If the vehicle has been parked in direct sunlight during hot weather, open the windows for a short time to let the hot air inside the vehicle escape.
- After sufficient cooling has been achieved, switch back from recirculated air position to the fresh outside air position.
- To help reduce moisture inside of the windows on rainy or humid days, decrease the humidity inside the vehicle by operating the air conditioning system with the windows and sunroof closed.
- During air conditioning system operation, you may occasionally notice a slight change in engine speed as the air conditioning compressor cycles. This is a normal system operation characteristic.
- Use the air conditioning system every month only for a few minutes to ensure maximum system performance.
- When using the air conditioning system, you may notice clear water dripping (or even puddling) on the ground under the passenger side of the vehicle. This is a normal system operation characteristic.
- If you operate the air conditioner excessively, the difference between the temperature of the outside air and that of the windshield may cause the outer surface of the windshield to fog up, causing loss of visibility. In this case, set the mode selection button to the  position and set the fan speed control knob to the lowest speed setting.

System maintenance

Cabin air filter

Information

- Replace the filter according to the Maintenance Schedule.
- If the car is being driven in severe conditions such as dusty, rough roads, more frequent cabin air filter inspections and changes are required.
- When the air flow rate suddenly decreases, have the system inspected by an authorized HYUNDAI dealer.

Checking the amount of air conditioner refrigerant and compressor lubricant

If the amount of refrigerant is too low or too high, the performance of the air conditioning is reduced.

Have the system inspected by an authorized HYUNDAI dealer.

NOTICE

It is important that the correct type and amount of oil and refrigerant are used. Otherwise, damage to the compressor and abnormal system operation may occur. To prevent damage, the air conditioning system in your vehicle should only be serviced by trained and certified technicians.

NOTICE

- The refrigerant system should only be serviced by trained and certified technicians in a well-ventilated area to ensure proper and safe operation.
- Never repair the air conditioning evaporator (cooling coil) or replace with the one removed from a used or salvaged vehicle. A new replacement evaporator must be certified (and labeled) as meeting SAE Standard J2842.

⚠ WARNING

To prevent serious injury, have the air conditioning system be serviced by only trained and certified technicians. R-1234yf is flammable and operated at high pressure.

Reclaim all refrigerants with proper equipment. Venting refrigerants directly to the atmosphere is harmful to individuals and environment.

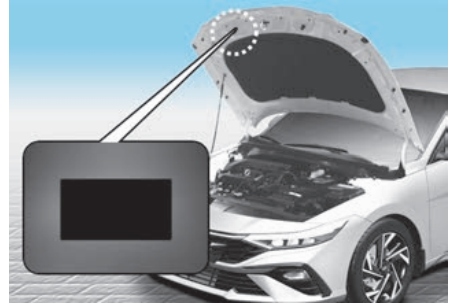
Air conditioning refrigerant label

You can find out which air conditioning refrigerant is applied to your vehicle on the label located inside of the hood.

Example

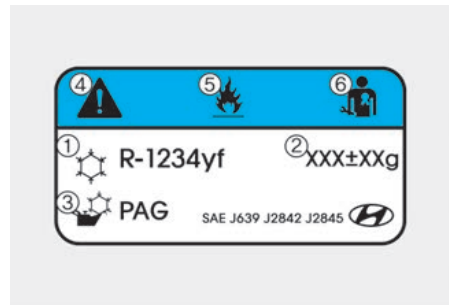



Each symbols and specification on the air conditioning refrigerant label is represented as the following:

1. Classification of refrigerant
2. Amount of refrigerant
3. Classification of Compressor lubricant
4. Caution
5. Flammable refrigerant
6. To require registered technician to service air conditioning system

Windshield defrosting and defogging

WARNING

Do not use the defrost-level  position during the cooling operation in extremely humid weather. The outer surface of the windshield may fog and reduce visibility, causing a collision that results in serious injury or death.



Set the mode selection button to the face-level  position and lower the fan speed.

- For maximum defrost performance, set the temperature control to the highest temperature setting and the fan speed control to the highest setting.
- If warm air to the floor is desired while defrosting or defogging, select the floor-defrost position.
- Before driving, clear all snow and ice from the windshield, rear window, side view mirrors, and all side windows.
- Clear all snow and ice from the hood and air inlet to improve heater and defroster efficiency and to reduce the probability of fogging up the inside of the windshield.

Manual climate control system

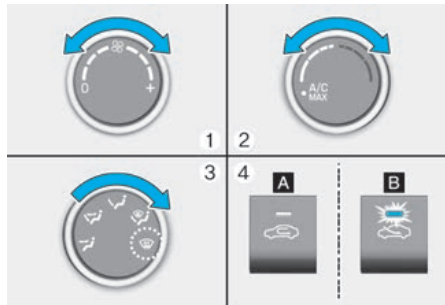
To defog inside windshield





1. Select any fan speed.
2. Select the desired temperature.
3. Select the  or  position.

The outside (fresh) air is selected automatically. The air conditioning automatically operates if the mode is selected to the defrost-level  position.

If the air conditioning and outside (fresh) air position are not selected automatically, press the corresponding button.

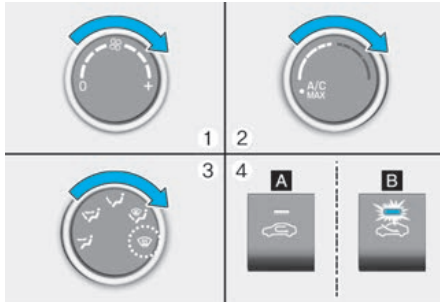
To defrost outside windshield



1. Set the fan speed to the highest (extreme right) position.
2. Set the temperature to the hottest position.
3. Select the  position.
The outside (fresh) air and air conditioning is selected automatically.

Automatic climate control system

To defog inside windshield

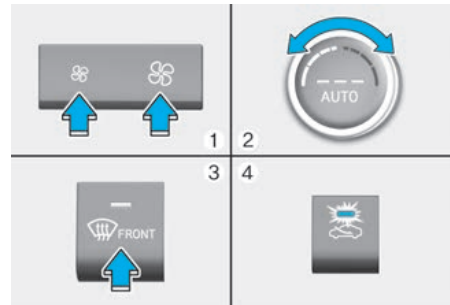

1. Select the desired fan speed.
2. Select the desired temperature.
3. Press the defroster button ().

The air conditioning turns on according to the detected ambient temperature, the outside (fresh) air position and higher fan speed are selected automatically.

If the air conditioning, outside (fresh) air position and higher fan speed are not selected automatically, adjust the corresponding button or knob.

If the defrost-level  position is selected, the fan speed increases.

To defrost outside windshield

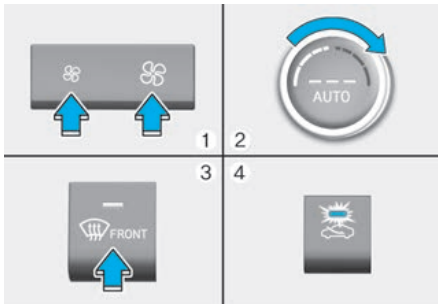

1. Set fan speed to the highest position.
2. Set temperature to the extreme hot (HI) position.
3. Press the defroster button (☀️).

The air conditioning turns on according to the detected ambient temperature and the outside (fresh) air position is selected automatically.

If the defrost-level (☀️) position is selected, lower fan speed is adjusted to higher fan speed.

Defogging logic

If equipped

To help reduce the probability of fogging up the inside of the windshield, the air intake or air conditioning are controlled automatically according to certain conditions such as (🌬️) or (☀️) position. To cancel or return the defogging logic, do the following

Manual climate control system

1. Turn the ignition switch to the ON position.
2. Select defroster mode (☀️).
3. Press the air intake control button at least 5 times within 3 seconds. The process should be completed within 10 seconds after the defroster mode (☀️) is selected.

The LED indicator on the air intake button will blink 3 times to indicate that the defogging logic has been disabled.

Repeat the steps again to re-enable the defogging logic.

If the battery has been discharged or disconnected, it resets to the defog logic status.

Automatic climate control system

1. Turn the ignition switch to the ON position.
2. Press the defroster button (☀️).
3. While pressing the air conditioning button (A/C), press the air intake control button at least 5 times within 3 seconds.

The automatic climate control information screen will blink 3 times to indicate that the defogging logic has been disabled.

Repeat the steps again to re-enable the defogging logic.

If the battery has been discharged or disconnected, it resets to the defog logic status.

Rear window defroster

NOTICE

Never use sharp instruments or window cleaners containing abrasives to clean the window to prevent damage to the rear window defroster.

The defroster heats the window to remove frost, fog, and thin ice from the interior and exterior of the rear window, while the engine is running.

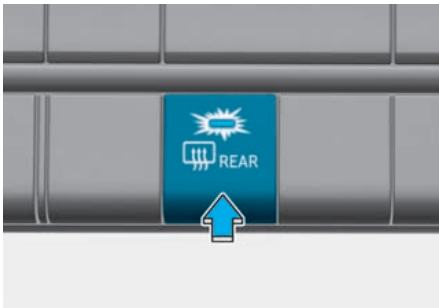

- To activate it, press the rear window defroster button located in the center control panel. The indicator on the rear window defroster button illuminates when the defroster is ON.
- To turn it off, press the rear window defroster button again.

i Information

- If there is heavy accumulation of snow on the rear window, brush it off before operating the rear defroster.
- The rear window defroster automatically turns off after about 20 minutes or when the ignition switch is in the LOCK/OFF position.

Side view mirror defroster

+ if equipped

The side view mirror defrosters operate when you turn on the rear window defroster.

Auto defogging system (only for automatic climate control system)

+ if equipped

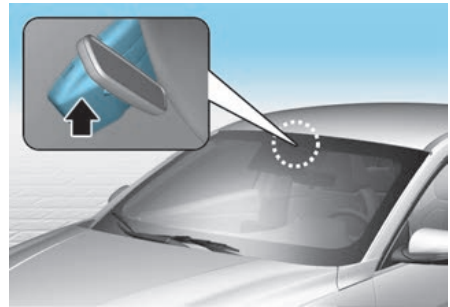

Auto defogging helps reduce the possibility of fogging up the inside of the windshield by automatically sensing the moisture on inside the windshield.

The auto defogging system operates when the heater or air conditioning is on.

i Information

The Auto Defogging system may not operate normally, when the outside temperature is below 14 °F (-10 °C).



When the Auto Defogging System operates, the indicator illuminates.

If a high amount of humidity is detected in the vehicle, the Auto Defogging System is enabled.

The following steps are performed automatically:

Step 1) A/C button turns on.

Step 2) Air intake control changes to outside (fresh) air position under low outside temperature.

Step 3) Defrost-level is selected.

Step 4) Fan speed increases.

To cancel or reset the Auto Defogging System

Press the front windshield defroster button for 3 seconds when the ignition switch is in the ON position.

When the Auto Defogging System is canceled, the defroster button indicator blinks 3 times.

When the Auto Defogging System is reset, the defroster button indicator blinks 6 times without a signal.

i Information

- When the air conditioning is turned on by Auto defogging system, if you try to turn off the air conditioning, the indicator blinks 3 times and the air conditioning does not turn off.
- Do not select recirculated air while the Auto defogging system is operating.
- When the Auto Defogging System is operating, fan speed adjustment, temperature adjustment, and air intake control selection are all disabled.

NOTICE

Do not remove the sensor cover located on the top of the windshield glass.

Damage may not be covered by your vehicle warranty.

Climate control additional features

Sunroof inside air recirculation

 if equipped

When the sunroof is opened, the outside (fresh) air position is automatically selected. If you press the air intake control button, the recirculated air position is selected but changes back to the outside (fresh) air position after 3 minutes. When the sunroof is closed, the air intake position returns to the previous position.

Automatic ventilation

 if equipped

The system automatically selects the outside (fresh) air position when the climate control system operates over a certain period of time (about 30 minutes) in low temperature with the recirculated air position selected.

To cancel or reactivate the automatic ventilation

When the air conditioning system is on, select Face Level  mode and press the recirculation mode button at least 5 times within 3 seconds while pressing the A/C button.

When the automatic ventilation is canceled, the indicator blinks 3 times.

When the automatic ventilation is activated, the indicator blinks 6 times.

Automatic controls for the driver based on climate control system settings

 if equipped

The temperature of the driver's seat warmer is automatically controlled depending on the inside and outside temperature of the vehicle when the engine is running.

These features must be enabled from the Settings menu in the infotainment system.

Select: **Setup > Vehicle > Seat (or Climate) > Warmer/Ventilation Features**

For more information on Auto Comfort Control, refer to the "Seat warmers" sections in chapter 3.

Storage compartment

WARNING

Never store cigarette lighters, propane cylinders, or other flammable/explosive materials in the vehicle. These items may catch fire and/or explode if the vehicle is exposed to hot temperatures for an extended period of time.

WARNING

Always keep the storage compartment covers closed securely while driving. Items inside your vehicle are moving as fast as the vehicle. If you have to stop or turn quickly, or if there is a collision, the items may fly out of the compartment and may cause an injury if they strike the driver or passengers.

NOTICE

To avoid possible theft, do not leave valuables in the storage compartments.

Center console storage

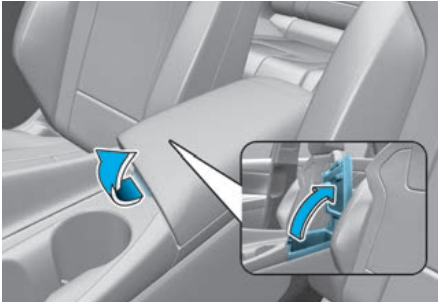

To open:

Grab and hold the latch on the armrest then lift the lid.

Glove box

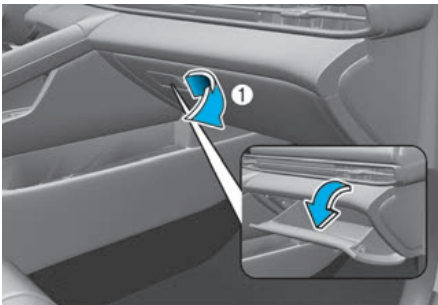

To open:

Pull the lever (1).

WARNING

Always close the glove box door after use.

An open glove box door may cause serious injury to a passenger in a collision, even if the passenger is wearing a seat belt.

Interior features

Cup holder

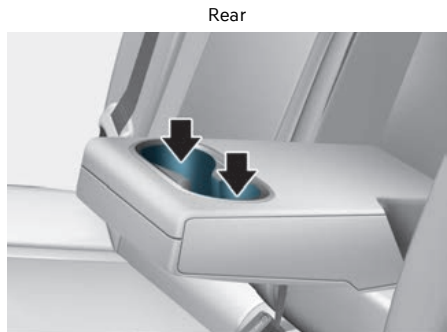
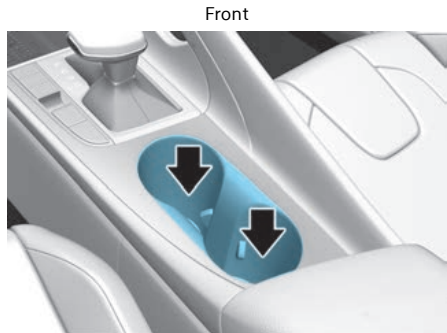

Cups or small beverages cups may be placed in the cup holders.

WARNING

- Avoid abrupt starting and braking when the cup holder is used to prevent spilling your drink. If hot liquid spills, you may be burned.

Such a burn to the driver may cause loss of vehicle control resulting in a collision.

- Only use soft cups in the cup holders.

NOTICE

- Keep your drinks sealed while driving to prevent spilling.
- When cleaning spilled liquids, do not use hot air to blow out or dry the cup holder.
- Keep cans or bottles out of direct sun light and do not put them in a hot vehicle. Otherwise, they may explode.

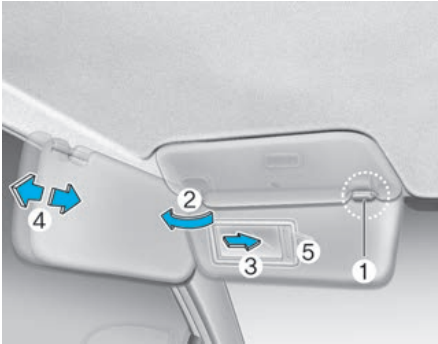
Sunvisor

To use the sunvisor, pull it downward.

To use the sunvisor to block the sun from the side window, pull it downward, release it from the bracket (1) and swing it to the side (2) toward the window.

To use the vanity mirror, pull down the sunvisor and slide the mirror cover (3).

Adjust the sunvisor forward or backward (4) as needed (if equipped). Use the ticket holder (5) to hold tickets.

Close the vanity mirror cover securely and return the sunvisor to its original position after use.

! WARNING

Do not block your view or the roadway when using the sunvisor.

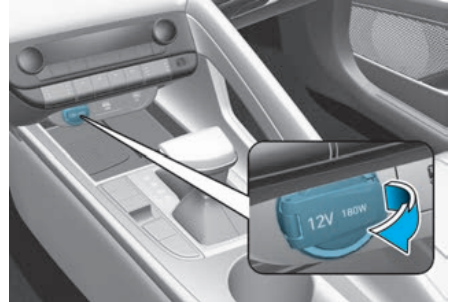
Power outlet

The power outlet is designed to provide power for mobile phones or other devices designed to operate with vehicle electrical systems.

The devices should draw less than 180 watts with the engine running.

! WARNING

Avoid electrical shocks. Do not place your fingers or foreign objects (pin, etc.) into a power outlet or touch the power outlet with a wet hand.

NOTICE

To prevent damage to the power outlets:

- Use the power outlet only when the engine is running and remove the accessory plug after use. Using the accessory plug for an extended period of time with the engine off may cause the battery to discharge.
- Only use 12 volts electric accessories that are less than 180 watts in the electric capacity.
- Adjust the air conditioner or heater to the lowest operating level when using the power outlet.
- Close the cover when not used.
- Some electronic devices may cause electronic interference when plugged into a vehicle's power outlet.
- Push the plug in as far as it goes. The plug may overheat and the fuse may open.
- Only connect devices with reverse current protection or the current from the device battery may cause the vehicle's electrical/electronic system to malfunction.

USB charger

Front seat

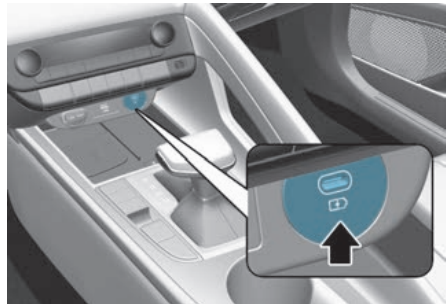

Rear seat

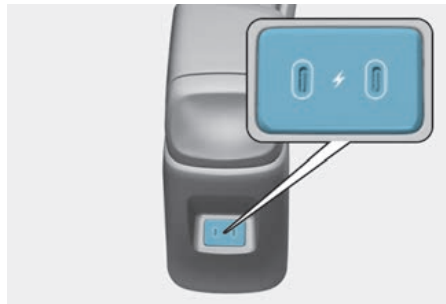

The USB charger is designed to recharge batteries of small size electronic devices using a USB cable.

The electrical devices can be charged when the ignition switch is in the ON or START position.

i Information

- Disconnect the USB cable from the USB port after use.
- The battery charging state may be monitored on the electrical device.
- A smartphone or a tablet PC may get warmer during the charging process. It does not indicate any malfunction with the charging system.
- A smartphone or a tablet PC that does not use a USB cable to charge should be charged using its own charger.
- Charging may not be possible when using a Type-C to A converter sold by a mobile phone manufacturer or commercially available.
- Do not attempt to use the charging terminal to turn ON an audio or to play media with the infotainment system.
- Use the USB charger when the engine is running. Using the USB charger for prolonged periods of time with the ignition switch in the ON position (engine off) may cause the battery to discharge.
- To prevent damage to the USB charger:
 - Do not insert foreign objects or spill liquid into the outlet. The USB charging terminal may be damaged.
 - Do not use devices with working current exceeding 3,000 mA (3.0 A).

Wireless smartphone charging system

 if equipped

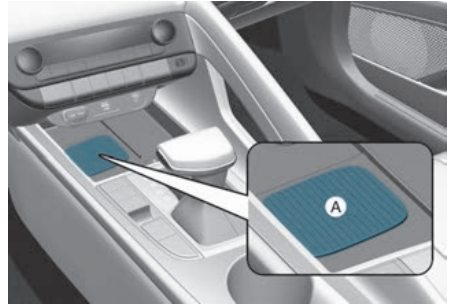

[A] Charging pad

Charging smartphone

The wireless smartphone charging system charges only the Qi-enabled smartphones (Qi).

Visit your smartphone manufacturer's website to check whether your smartphone supports the Qi technology.

The wireless charging process starts when you put a Qi-enabled smartphone on the wireless charging unit with the screen facing up.

1. The wireless smartphone charger is available when all doors are closed, and when the ignition switch is in the ON or START position.
2. Turn on the wireless charging function from the Settings menu in the instrument cluster or infotainment system. Select:
 - **User Settings > Convenience > Wireless Charging System** (for instrument cluster type)
 - **Settings > Vehicle > Convenience > Wireless Charging System** (for infotainment system type)

- Place the smartphone on the center of the wireless charging pad. The indicator light is orange when the smartphone is charging and turns green when phone charging is complete.

i Information

- Remove other items, including the smart key from the wireless charging pad.
- For flip type smartphones, when using wireless charging, place the smartphone folded with the device's back placed on the center of the wireless charging unit.

If your smartphone is not charging:

- Make sure all doors are closed.
- Move the smartphone on the charging pad.
- Make sure the indicator light is orange.

The indicator light blinks orange for 10 seconds if there is a malfunction in the wireless charging system.

The system warns you with a message on the cluster display if the smartphone is still on the wireless charging pad after the vehicle is turned OFF and the front door is opened.

i Information

- The wireless smart phone charging system may not support smartphones that do not meet the (Qi) specification.
- When placing your smartphone on the charging pad, position the phone in the middle of the mat for optimal charging performance. If your smartphone is off to the side, the charging rate may be less and in some cases the smartphone may experience higher heat conduction.
- Wireless charging may stop temporarily when the smart key is used, or when starting the vehicle or locking/unlocking the doors.
- When charging certain smartphones, the charging indicator may not change to green when the smartphone is fully charged.
- The wireless charging process may temporarily stop, when the temperature abnormally increases inside the wireless smartphone charging system. The wireless charging process does not restart, until the temperature falls.
- The wireless charging process may stop when there is any metallic item, such as coin, between the wireless smartphone charging pad and smartphone.
- For some manufacturer's smartphones, the system may not warn you even though the smartphone is left on the wireless charging unit. This is due to the particular characteristic of the smartphone and not a malfunction of the wireless charging.
- When charging some smartphones with a self-protection feature, the wireless charging speed may decrease and the wireless charging may stop.
- If the smartphone has a thick case, it may not charge.

- If the smartphone is not completely contacting the charging pad, wireless charging may not operate properly.
- Some magnetic items such as credit cards, phone cards, or transit cards may be damaged if left with the smartphone during the charging process.
- When any smartphone without a wireless charging function or a metallic object is placed on the charging pad, a small noise may be because the vehicle discerns compatibility of the object placed on the charging pad. It does not affect your vehicle or the smartphone.
- Some smartphones may not be able to charge depending on the internal structure of the smartphone. If this occurs, try charging the smartphone by moving it to the left or right side of the wireless charging pad. However, for some foldable smartphones that have magnets inside the smartphone, try charging the smartphone while holding it close to the left side of the wireless charging pad.
- If the gear is shifted to P (Park) when the digital key is not registered, wireless charging may stop temporarily.
- If the ignition switch is in the LOCK/OFF position, the charging stops.

Clock

The clock can be set from the infotainment system.

For more information, refer to the infotainment system manual.

WARNING

Do not attempt to adjust the clock while driving.

Coat hook

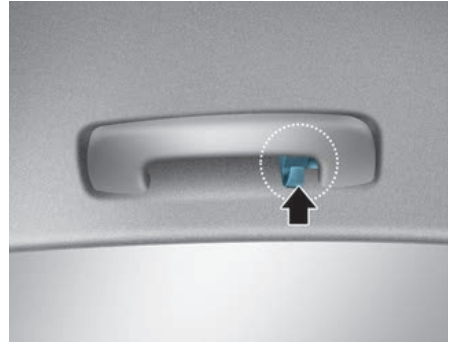

These hooks are not designed to hold large or heavy items.

WARNING

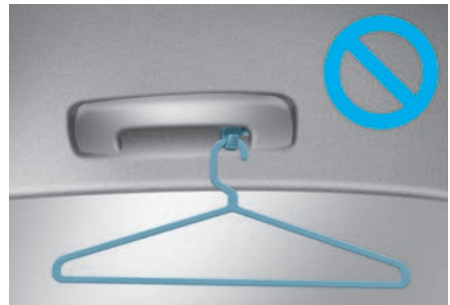

Only hang soft clothing without heavy, sharp or breakable objects in the clothes pockets. In a collision or when the curtain airbag is inflated, the objects could move and cause serious injury.

Infotainment system

NOTICE

- Do not install an aftermarket HID headlight. Your vehicle's audio and electronic devices may not function properly.
- Prevent chemicals such as perfume, cosmetic oil, sun cream, hand cleaner, and air freshener from contacting the interior parts because they may cause damage or discoloration.

USB port

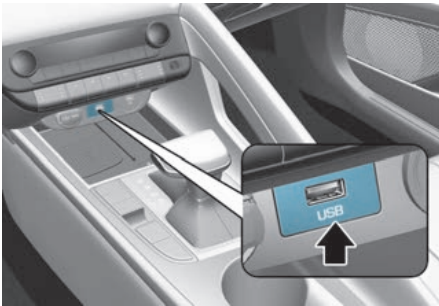

The USB port can be used while the engine is running.

- Small electronic devices can be charged.
- After connecting a media storage device such as a MP3 or USB to the USB port, you can listen to music through the vehicle's speakers or play it on the infotainment system.

i Information

- Some devices may not be charged through USB port.
- When using a portable audio device connected to the power outlet, noise may occur during playback. If this happens, disconnect the USB cable and use the portable audio device's power source.

Antenna

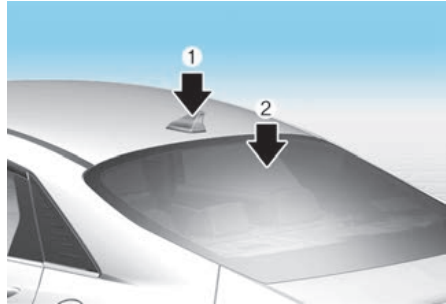

Shark fin antenna (1)

The shark fin antenna receives data transmitted from base stations and satellites (e.g. GPS, Sirius XM, LTE) and also transmits to base stations (e.g. LTE).

Glass antenna (2)

Your vehicle uses a glass antenna to receive both AM and FM signals.

NOTICE

- Do not clean the inside of the rear window glass with a cleaner or scraper to remove foreign deposits as this may cause damage to the antenna elements.
- To prevent damage to the rear glass antenna, never use sharp instruments or window cleaner containing abrasives to clean the window. Clean the inside surface of the rear glass window with a piece of soft cloth.
- When putting a sticker on the inside surface of the rear window, be careful not to damage the rear glass antenna.
- Do not put sharp instruments nearby the rear glass antenna.

i Information

- Avoid adding metallic coatings such as Nickel, Cadmium, etc. These can degrade the receiving AM and FM broadcast signals.
- Tinted rear window may affect the proper functioning of the antenna.

Steering wheel audio controls

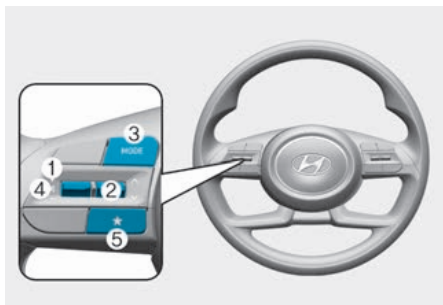

NOTICE

Do not operate multiple audio remote control buttons simultaneously.

VOLUME (VOL + / VOL -) (1)

- Rotate the VOLUME scroll up to increase volume.
- Rotate the VOLUME scroll down to decrease volume.

SEEK/PRESET (∧ / ∨) (2)

If the SEEK/PRESET switch is pressed up or down and held for 0.8 seconds or more, it functions in the following modes:

RADIO mode

It functions as the AUTO SEEK select button. It seeks until you release the button.

MEDIA mode

It functions as the FF/RW button.

If the SEEK/PRESET switch is pressed up or down, it functions in the following modes.

RADIO mode

It functions as the PRESET STATION UP/DOWN button.

MEDIA mode

It functions as the TRACK UP/ DOWN button.

MODE (3)

Press the MODE button to toggle through Radio mode.

MUTE (🔇) (4)

Press the MUTE button to mute or activate the sound.

Custom button (★) (5)

- Custom function
- Press and hold to move to the function setting screen.

i Information

For more information, refer to the separately supplied infotainment system manual.

Infotainment system

 If equipped

For more information, refer to the infotainment system manual.

Voice recognition

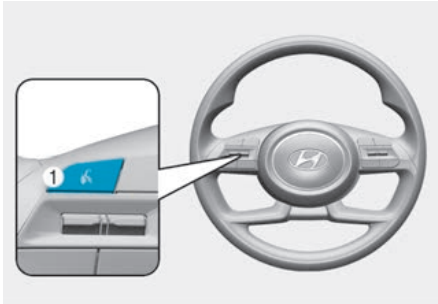

For more information, refer to the separately supplied infotainment system manual.

Bluetooth® wireless technology

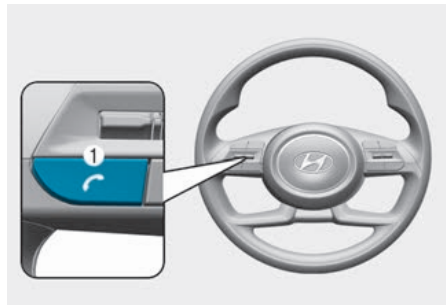

- (1) Call/Answer/Call end button
- (2) Left Microphone
- (3) Right Microphone (if equipped)

For more information, refer to the infotainment system manual.

WARNING

To prevent driver distraction, minimize your use of these features while driving. Distraction may cause a collision, resulting in serious injury or death.

How vehicle radio works

FM reception

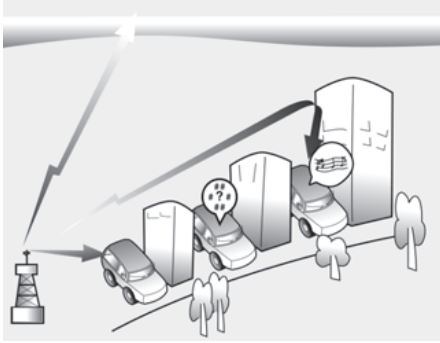

AM and FM radio signals are broadcast from transmitter towers located around your city. They are intercepted by the radio antenna on your vehicle. This signal is then received by the radio and sent to your vehicle speakers.

When a strong radio signal has reached your vehicle, the precise engineering of your audio system ensures the best possible quality reproduction. However, in some cases the signal coming to your vehicle may not be strong and clear.

This can be due to factors, such as the distance from the radio station, closeness of other strong radio stations or the presence of buildings, bridges or other large obstructions in the area.

AM (MW, LW) reception

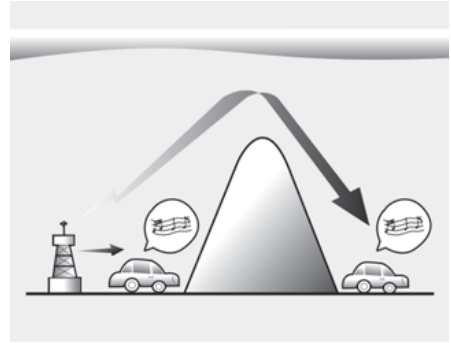

AM broadcasts can be received at greater distances than FM broadcasts. This is because AM radio waves are transmitted at low frequencies. These long, low frequency radio waves can follow the curvature of the earth rather than travelling straight out into the atmosphere. In addition, they curve around obstructions so that they can provide better signal coverage.

FM radio station

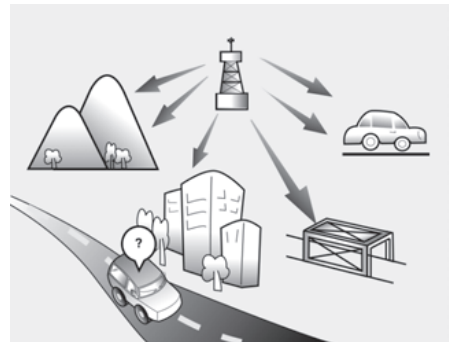

FM broadcasts are transmitted at high frequencies and do not bend to follow the earth's surface. Because of this, FM broadcasts generally begin to fade at short distances from the station. Also, FM signals are easily affected by buildings, mountains, or other obstructions.

These can result in certain listening conditions which might lead you to believe a problem exists with your radio. The following conditions are normal and do not indicate radio trouble :

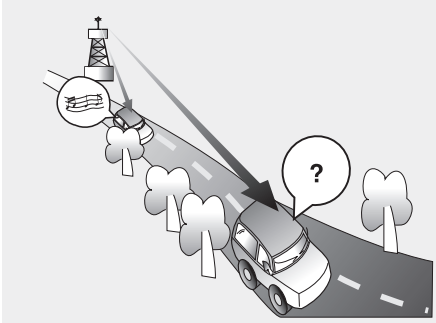

- **Fading** As your vehicle moves away from the radio station, the signal will weaken and sound will begin to fade. When this occurs, we suggest that you select another stronger station.
- **Flutter/Static** Weak FM signals or large obstructions between the transmitter and your radio can disturb the signal causing static or fluttering noises to occur. Reducing the treble level may lessen this effect until the disturbance clears.

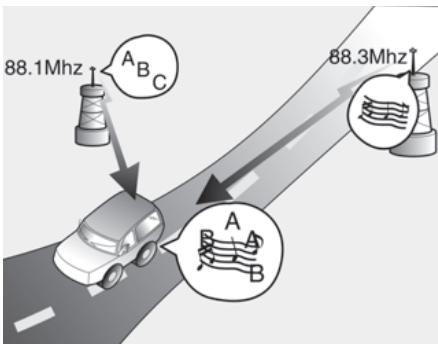

- **Station Swapping** As a FM signal weakens, another more powerful signal near the same frequency may begin to play. This is because your radio is designed to lock onto the clearest

signal. If this occurs, select another station with a stronger signal.

- **Multi-Path Cancellation** Radio signals being received from several directions can cause distortion or fluttering. This can be caused by a direct and reflected signal from the same station, or by signals from two stations with close frequencies. If this occurs, select another station until the condition has passed.

Using a cellular phone or a two-way radio

When a cellular phone is used inside the vehicle, its signal may interfere with the audio system.

NOTICE

When using a communication system such as a cellular phone or a radio set inside the vehicle, a separate external antenna must be fitted. When a cellular phone or a radio set is used with an internal antenna alone, it may interfere with the vehicle's electrical system and adversely affect safe operation of the vehicle.

! WARNING

Do not use a cellular phone while driving. Otherwise, it may cause a collision, resulting in serious injury or death. Stop at a safe place to use a cellular phone.

6. Driving your vehicle

| | |
|---|------|
| Before driving | 6-4 |
| Before entering the vehicle..... | 6-4 |
| Before starting | 6-4 |
| Vehicle break-in process..... | 6-5 |
| Key ignition switch | 6-5 |
| Key ignition switch positions | 6-7 |
| Starting the engine | 6-8 |
| Turning off the engine | 6-8 |
| Push button start ignition switch | 6-9 |
| Push button start ignition switch positions | 6-10 |
| Starting the engine | 6-11 |
| Turning off the engine | 6-12 |
| Remotely starting the engine..... | 6-12 |
| Vehicle Auto-Shut Off | 6-13 |
| Operating conditions | 6-13 |
| System operation..... | 6-13 |
| Deactivating conditions | 6-13 |
| Intelligent Variable Transmission | 6-14 |
| Intelligent Variable Transmission operation | 6-15 |
| Parking | 6-18 |
| Good driving practices | 6-18 |
| Dual Clutch Transmission | 6-20 |
| Dual Clutch Transmission operation | 6-21 |
| DCT warning messages..... | 6-25 |
| Parking | 6-26 |
| Paddle shifter (Manual shift mode) | 6-27 |
| Good driving practices | 6-27 |
| Braking system | 6-28 |
| Power-assist brakes..... | 6-28 |
| Disc brakes wear indicator..... | 6-29 |
| Parking brake..... | 6-29 |
| Electronic Parking Brake (EPB) | 6-31 |
| Auto Hold..... | 6-34 |
| Anti-lock Brake System (ABS)..... | 6-36 |
| Electronic Stability Control (ESC) | 6-38 |
| Vehicle Stability Management (VSM)..... | 6-40 |

| | |
|--|------|
| Hill-start Assist Control (HAC) | 6-41 |
| Good braking practices | 6-42 |
| Idle Stop and Go (ISG) system | 6-42 |
| Auto stop | 6-42 |
| Auto start | 6-43 |
| Operating conditions | 6-44 |
| Deactivating the ISG | 6-44 |
| ISG malfunction | 6-45 |
| Smart ISG features | 6-45 |
| Drive mode integrated control system | 6-49 |
| Selecting drive mode | 6-49 |
| NORMAL, SPORT, SMART mode features | 6-50 |
| Smart shift on trip computer | 6-51 |
| Special driving conditions | 6-51 |
| Hazardous driving conditions | 6-51 |
| Rocking the vehicle | 6-51 |
| Smooth cornering | 6-52 |
| Driving at night | 6-52 |
| Driving in the rain | 6-52 |
| Driving in flooded areas | 6-53 |
| Highway driving | 6-53 |
| Winter driving | 6-54 |
| Snow or icy conditions | 6-54 |
| Winter precautions | 6-55 |
| Trailer towing | 6-57 |
| Vehicle load limit | 6-57 |
| The loading information label | 6-58 |

 **WARNING**

Carbon monoxide (CO) gas is toxic. Breathing CO may cause unconsciousness and death.

Engine exhaust contains carbon monoxide that cannot be seen or smelled.

Do not inhale engine exhaust.

If at any time you smell engine exhaust inside the vehicle, open the windows immediately. Exposure to CO may cause unconsciousness and death by asphyxiation.

Make sure the exhaust system does not leak.

The exhaust system should be checked whenever the vehicle is raised to change the oil or for any other purposes. If you hear a change in the sound of the exhaust or drive over something that strikes the underneath side of the vehicle, have the exhaust system checked as soon as possible by an authorized HYUNDAI dealer.

Do not run the engine in an enclosed area.

Letting the engine idle in your garage, even with the garage door open, is a hazardous practice. Run the engine only long enough to start the engine and to move the vehicle out of the garage. Run as possible by an authorized HYUNDAI dealer.

Avoid idling the engine for an extended period of time with people inside the vehicle.

If it is necessary to idle the engine for a long time with people inside the vehicle, be sure to do so only in an open area with the air intake set at "Fresh" and fan control set to high so fresh air is drawn into the interior.

Keep the air intakes clear.

To ensure proper operation of the ventilation system, keep the ventilation air intakes located in front of the windshield clear of snow, ice, leaves, or other obstructions.

If you must drive with the trunk open:

Close all windows.

Open instrument panel air vents.

Set the air intake control at "Fresh", the air flow control at "Floor" or "Face", and the fan control set to high.

Before driving

Before entering the vehicle

- Make sure all windows, outer side view mirror(s), and outside lights are clean and unobstructed.
- Remove frost, snow, or ice from both the front and rear windshield as well as the front side windows.
- Visually check the tires for uneven wear and damage.
- Check under the vehicle for any sign of leaks.
- Make sure there are no obstacles behind you if you intend to back up.

Before starting

- Make sure the hood, the trunk, and the doors are securely closed and locked.
- Adjust the position of the seat and steering wheel.
- Adjust the inside and side view mirrors.
- Verify all the lights work.
- Fasten your seat belt. Check that all passengers have fastened their seat belts.
- Check the gauges and indicators in the instrument panel and the messages on the instrument display when the ignition switch is in the ON position.
- Check that any items you are carrying are stored properly or fastened down securely.

WARNING

To reduce the risk of serious injury or death:

- Always wear your seat belt. All passengers must be properly belted whenever the vehicle is moving. For more information, refer to the "Seat belts" section in chapter 3.
 - Always drive defensively. Do not assume that the other drivers are seeing your vehicle. They may not act as you expect. Be prepared to react to avoid a possible collision. Plan your movements anticipating the "worst-case" scenario.
 - Stay focused on driving. Driver distraction may cause a collision.
 - Leave plenty of space between you and the vehicle in front of you.
-

WARNING

Never drink or take drugs while driving.

Drinking or taking drugs while driving is dangerous and may result in a collision, causing serious injury or death.

Drunk driving is the number one contributor to the highway death toll each year. Even a small amount of alcohol can affect your reflexes, perceptions, and judgment. Just one drink may reduce your ability to respond to changing conditions and emergencies and your reaction time gets worse with each additional drink.

Driving while under the influence of drugs is as dangerous or more dangerous than driving under the influence of alcohol.

You are much more likely to have a serious accident if you drink or take drugs while driving. If you are drinking or taking drugs, never drive. Do not ride with a driver who has been drinking or taking drugs. Choose a designated driver or call a taxi.

Vehicle break-in process

By following a few simple precautions for the first 600 mi. (1,000 km), you can add to the performance, economy, and life of your vehicle.

- While driving, avoid sudden acceleration.
- Do not maintain a single speed for a long time, either fast or slow. Varying the engine speed is needed to properly break-in the engine.
- Avoid hard stops, except in emergencies, to allow the brakes to seat properly.
- Fuel economy, engine performance, and engine oil consumption may differ depending on the vehicle break-in process and be stabilized after 4,000 mi. (6,000 km). New engines may consume more oil during the vehicle break-in period.
- Do not tow a trailer during the first 1,200 mi. (2,000 km) of operation.

Key ignition switch

 if equipped

WARNING

To reduce the risk of serious injury or death:

- Never allow children or any person who is unfamiliar with the vehicle to touch the ignition switch or related parts. Unexpected and sudden vehicle movement may occur.
- Never reach through the steering wheel for the ignition switch, or any other control, while the vehicle is moving. The presence of your hand or arm in this area may cause a loss of vehicle control resulting in a collision.



- [A] Lock
- [B] ACC
- [C] ON
- [D] START

Whenever the front door is opened, the ignition switch illuminates if the ignition switch is not in the ON position. The light goes off immediately when the ignition switch is turned ON or goes off after about 30 seconds when the door is closed. (for vehicles equipped with ignition switch illumination)



WARNING

- Never turn the ignition switch to the LOCK or ACC position while the vehicle is moving except in an emergency. This may result in the engine turning off and loss of power assist for the steering and brake systems. This may cause loss of directional control and braking function, which could cause a collision.
 - Before leaving the driver's seat, always make sure the shift lever is in the P (Park) position, apply the parking brake, turn the ignition switch to the LOCK position, and take the keys with you to prevent unintended vehicle movement.
-

NOTICE

Never use aftermarket keyhole covers. These covers may prevent the vehicle from recognizing the key and not allow the vehicle to start.

Key ignition switch positions

| Switch Position | Action | Notes |
|-----------------|--|---|
| LOCK | To turn the ignition switch to the LOCK position, push the key in at the ACC position and turn the key towards the LOCK position. The ignition key can be removed in the LOCK position. | Always stop the vehicle before turning the ignition switch to the LOCK position. |
| ACC | Some electrical accessories are usable. The steering wheel unlocks. | |
| ON | This is the normal key position when the engine has started. All features and accessories are usable. The warning lights can be checked when you turn the ignition switch from ACC to ON. | Do not leave the ignition switch in the ON position when the engine is not running to prevent the battery from discharging. |
| START | To start the engine, turn the ignition switch to the START position. The switch returns to the ON position when you let go of the key. | The engine attempts to start until you release the key. |

Starting the engine

WARNING

- Always wear appropriate shoes when operating your vehicle. Unsuitable shoes such as high heels, ski boots, sandals, and flip-flops may interfere with your ability to use the brake, accelerator, and clutch pedals. Do not drive barefoot.
 - Do not start your vehicle with the accelerator pedal depressed. Place your foot firmly on the brake pedal while starting your vehicle.
 - Wait until the engine is at normal idle before shifting gears and releasing the brake. Your vehicle may move suddenly if your vehicle is shifted while the engine RPM is high. It may cause damage to the transmission system.
-

1. Make sure the parking brake is applied.
2. Make sure the shift lever is in P (Park).
3. Depress the brake pedal.
4. Turn the ignition switch to the START position. Hold the key (maximum of 10 seconds) until the engine starts and release it.

i Information

- Do not wait for the engine to warm up or race the engine while the vehicle remains stationary.
 - Start driving at moderate engine speeds. Do not rapidly accelerate and decelerate while driving.
-

NOTICE

To prevent damage to the vehicle:

- Do not hold the ignition key in the START position for more than 10 seconds. Wait 5 to 10 seconds before trying again.
 - Do not turn the ignition switch to the START position with the engine running. It may damage the starter.
 - If the engine stalls while the vehicle is moving, shift to N (Neutral) and use the ignition switch to attempt to restart the engine.
 - Do not push or tow your vehicle to start the engine.
-

Turning off the engine

1. Stop the vehicle and depress the brake pedal fully.
2. Make sure the gear is in P (Park).
3. Turn the ignition switch to the LOCK position and apply the parking brake.
4. Take the key with you when you leave the vehicle.

Push button start ignition switch

 if equipped

WARNING

To reduce the risk of serious injury or death:

- Never allow children or any person who is unfamiliar with the vehicle to touch the Push Button Start ignition switch or related parts. Unexpected and sudden vehicle movement may occur.
- Never reach through the steering wheel for the ignition switch, or any other control, while the vehicle is moving. The presence of your hand or arm in this area may cause a loss of vehicle control resulting in a collision.



Whenever the front door is opened, the Push Button Start ignition switch illuminates and goes off 30 seconds after the door is closed. (if equipped)

WARNING

To turn off the vehicle in an emergency:

Press and hold the Push Button Start ignition switch for more than two seconds. Or rapidly press and release the Push Button Start ignition switch three times (within three seconds).

If the vehicle is still moving, you can restart the vehicle without depressing the brake pedal by pressing the Push Button Start ignition switch with the gear in the N (Neutral) position.

WARNING

- Never press the Push Button Start ignition switch while the vehicle is moving except in an emergency. This may result in the vehicle turning off and loss of power assist for the steering and brake systems. This may cause loss of directional control and braking function, which could cause an accident.
- Before leaving the driver's seat, always make sure the gear is in the P (Park) position, apply the parking brake, press the Push Button Start ignition switch to the OFF position, and take the Smart Key with you to prevent unintended vehicle movement.

Push button start ignition switch positions

| Button Position | Action | Notes |
|-----------------|---|--|
| OFF | <p>To turn off the engine, press the Push Button Start ignition switch with the vehicle shifted to P (Park).</p> <p>If the Push Button Start ignition switch is pressed with the gear shifted to D (Drive), R (Reverse), or N (Neutral), the Push Button Start ignition switch changes to the ACC position.</p> | <p>Always stop the vehicle before pressing the Push Button Start ignition switch to the OFF position.</p> |
| ACC | <p>Press the Push Button Start ignition switch when the button is in the OFF position without depressing the brake pedal.</p> <p>Some of the electrical accessories are usable.</p> | <p>If you leave the Push Button Start ignition switch in the ACC position for a period of time, the engine turns off automatically to prevent battery discharge.</p> |
| ON | <p>Press the Push Button Start ignition switch while it is in the ACC position without depressing the brake pedal.</p> <p>The warning lights can be checked before the engine is started.</p> | <p>Do not leave the Push Button Start ignition switch in the ON position when the engine is not running to prevent the battery from discharging.</p> |
| START | <p>To start the engine, depress the brake pedal and press the Push Button Start ignition switch with the gear shifted to the P (Park) or the N (Neutral) position.</p> <p>For your safety, start the engine with the gear shifted to the P (Park) position.</p> | <p>If you press the Push Button Start ignition switch without depressing the brake pedal, the engine does not start and the Push Button Start ignition switch changes as follows: OFF → ACC → ON → OFF or ACC</p> |

Starting the engine

WARNING

- Always wear appropriate shoes when operating your vehicle. Unsuitable shoes such as high heels, ski boots, sandals, and flip-flops may interfere with your ability to use the brake, accelerator, and clutch pedals. Do not drive barefoot.
- Do not start your vehicle with the accelerator pedal depressed. Place your foot firmly on the brake pedal while starting your vehicle.
- Wait until the engine is at normal idle before shifting gears and releasing the brake. Your vehicle may move suddenly if your vehicle is shifted while the engine RPM is high. It may cause damage to the transmission system.

i Information

- The vehicle starts by pressing the Push Button Start ignition switch, only when the smart key is in the vehicle.
- The vehicle may not start even if the smart key is in the vehicle but it is not near you (e.g. in the cargo area).
- When the Push Button Start ignition switch is in the ACC or ON position, if any door is open, the system checks for the smart key. When the smart key is not in the vehicle, the  indicator blinks and the warning, "Key not in vehicle" appears. When all doors are closed, the chime also sounds for about 5 seconds.

1. Always carry the smart key with you.
2. Make sure the parking brake is applied.
3. Make sure the shift lever is in P (Park).
4. Depress the brake pedal.
5. Press the Push Button Start ignition switch.

i Information

- Do not wait for the engine to warm up or race the engine while the vehicle remains stationary.
- Start driving at moderate engine speeds. Do not rapidly accelerate and decelerate while driving.

NOTICE

To prevent damage to the vehicle:

- Do not press the Push Button Start ignition switch for more than 10 seconds except when the stop light fuse is blown.
When the stop light fuse is blown, replace the fuse. If you cannot replace the fuse, start the engine by pressing and holding the Push Button Start ignition switch for 10 seconds with the Push Button Start ignition switch in the ACC position.
- If the engine stalls while the vehicle is moving, shift to N (Neutral) and use the Push Button Start ignition switch to attempt to restart the engine.
- Do not push or tow your vehicle to start the engine.

i Information

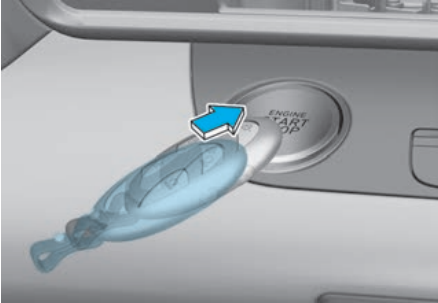

If the smart key battery is weak or the smart key does not work correctly, press the Push Button Start ignition switch with the smart key.

Turning off the engine

1. Stop the vehicle and depress the brake pedal fully.
2. Make sure the gear is in P (Park).
3. Press the Push Button Start ignition switch to the OFF position and apply the parking brake.
4. Take the key with you when you leave the vehicle.

Remotely starting the engine

+ If equipped



You can start the vehicle using the Remote Start button of on the smart key.

To start the vehicle remotely:

1. Press the door lock button within 32 ft. (10 m) from the vehicle.
2. Press and hold the remote start () button for more than 2 seconds within 4 seconds.

To turn off the engine:

Press the remote start () button once.

i Information

- The vehicle does not remotely start if the hood or trunk is open.
- The vehicle must be in P (Park).
- The engine turns off if you get in the vehicle without a registered smart key or you do not get in the vehicle within 10 minutes.

Vehicle Auto-Shut Off

 if equipped

If your vehicle is parked and the engine is left on for a long period of time, the engine turns off automatically to help reduce fuel consumption and prevent carbon dioxide poisoning.

Operating conditions

Vehicle Auto-Shut Off timer operates when all the following conditions are satisfied:

- The driver does not fasten their seat belt.
- No occupant is detected in the passenger's seat.
- The vehicle is stopped and the gear shift is in P (Park).
- If the brake or accelerator pedals have not been depressed.
- The infotainment system is not being updated.

System operation

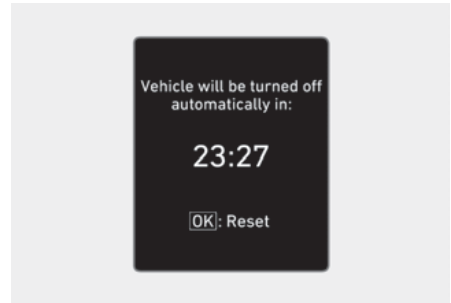

When all the conditions are satisfied, the Vehicle Auto-Shut Off operates and turns the engine off automatically after 60 minutes.

A timer appears on the instrument cluster 30 minutes before vehicle shuts off.

Resetting cluster timer

A timer appears on the instrument cluster after 30 minutes and is reset by:

- Releasing the accelerator pedal or brake pedals.
- Pressing the **OK** button on the steering wheel while the timer appears on the instrument cluster.

Deactivating conditions

The system does not automatically shut off the engine if:

- The driver's seat belt is fastened.
- An occupant is detected in the passenger's seat.
- Driving over 2 mph (3 km/h).
- The brake pedal or accelerator pedal is depressed.
- The gear is shifted to R (Reverse), D (Drive), or N (Neutral).

Intelligent Variable Transmission

 if equipped

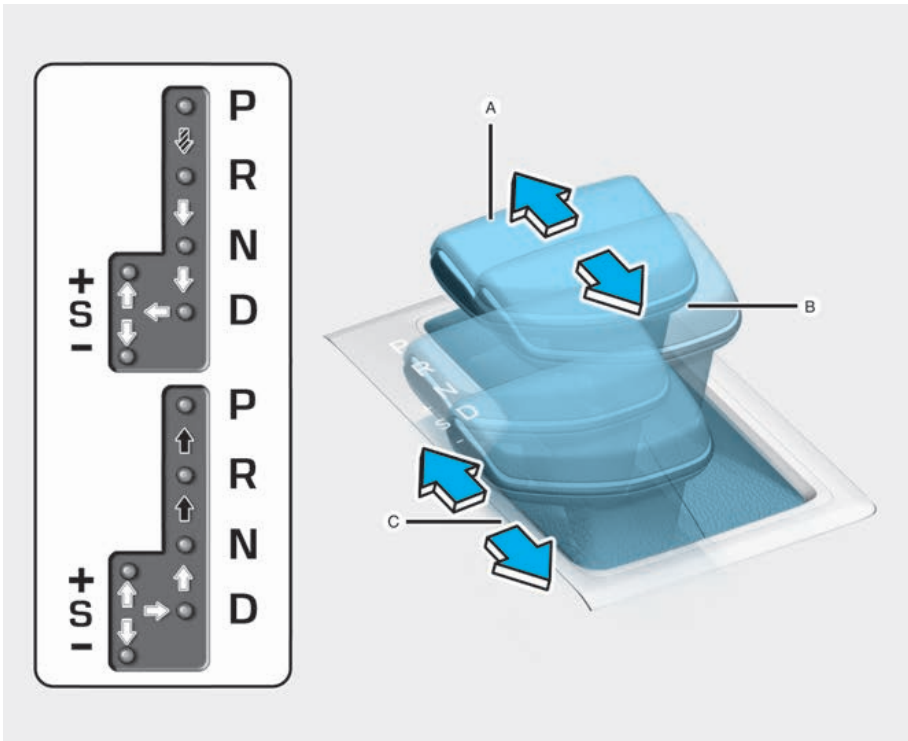

[A] Shift release button

[B] Shift lever

[C] DS mode, manual shift mode

 Depress the brake pedal and press the shift release button while moving the shift lever.

 Press the shift release button while moving the shift lever.

 The shift lever can freely operate.

Intelligent Variable Transmission operation

The Intelligent Variable Transmission (IVT) has no actual fixed gears. The varying gear ratios are selected automatically, depending on the position of the shift lever, vehicle's speed and position of the accelerator pedal.

The indicator on the instrument cluster the shift lever position when the ignition switch is in the ON position.

WARNING

To reduce the risk of serious injury or death:

- Always check the surrounding areas near your vehicle for people, especially children, before shifting into D (Drive) or R (Reverse).
- Before leaving the driver's seat, always make sure the shift lever is in the P (Park) position, then apply the parking brake, and place the ignition switch in the LOCK/OFF position. Unexpected and sudden vehicle movement may occur if these precautions are not followed.
- Do not use engine braking (using the manual shift mode to shift from a higher gear to a lower gear) on slippery roads. The vehicle may lose traction with the roadway, resulting in a collision.

P (Park)

Always come to a complete stop before shifting into P (Park).

To shift from P (Park), depress the brake pedal firmly and make sure your foot is not depressing the accelerator pedal.

If you cannot shift the lever out of P (Park), refer to the "Shift lock release" section in this chapter if equipped with a shift lever.

WARNING

- Shifting into P (Park) while the vehicle is moving may cause you to lose control of the vehicle.
- After the vehicle has stopped, always make sure the shift lever is in P (Park), apply the parking brake, and turn the engine off.
- When parking on an incline, shift the gear to P (Park), apply the parking brake, and turn the wheels toward the curb to prevent the vehicle from rolling downhill.
- Do not use the P (Park) position instead of the parking brake.

Information

The RPM (revolution per minute) may increase or decrease when performing the Intelligent Variable Transmission (IVT) self-diagnosis.

R (Reverse)

Use this position to drive the vehicle backward.

NOTICE

Always come to a complete stop before shifting into or out of R (Reverse) to prevent damaging the transmission.

N (Neutral)

The wheels and transmission are not engaged.

Use N (Neutral) if you need to restart a stalled engine, or if it is necessary to stop with the engine ON. Shift into P (Park) if you need to leave your vehicle for any reason.

Always depress the brake pedal when you are shifting from N (Neutral) to another gear.

⚠ WARNING

- Do not shift into gear unless your foot is firmly on the brake pedal.
 - Do not shift gears with the accelerator pedal depressed. Wait until the engine RPM is normal. The vehicle may suddenly move if you shift gears and release the brake pedal when the RPM is high.
-

D (Drive)

The transmission automatically shifts to the optimal gear ratio, providing the best fuel economy and power.

Shift to D (Drive) while depressing the brake pedal with the engine ON. Then release the brake pedal and depress the accelerator pedal.

For extra power when passing another vehicle or driving uphill, depress the accelerator pedal fully. The transmission automatically downshifts to the next lower gear.

The DRIVE MODE switch, located on the shift lever console or on the left side of the dashboard, allows the driver to switch from NORMAL mode to SPORT or SMART mode (if equipped).

For more information, refer to the "Drive mode integrated control system" section in this chapter.

DS (Drive Sporty) mode

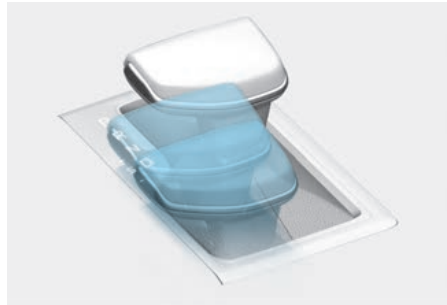

- To shift into DS mode, move the shift lever from D (Drive) to the center of the manual shift mode. The engine and transmission control logic is automatically optimized for sporty driving.
- In DS mode, if you move the shift lever to + (Up) or - (Down), the gear changes to the manual shift mode. If the shift lever is moved back into D (Drive), it changes to D (Drive) and shifts automatically. The vehicle performs according to the mode selected from the drive mode (NORMAL, SPORT, SMART).

Manual shift mode

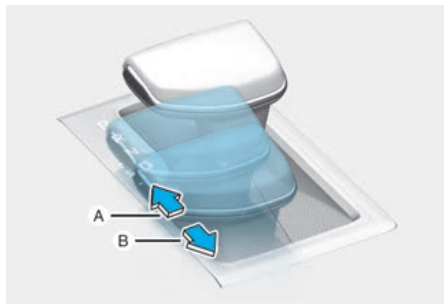

[A] + (Up)
[B] - (Down)

Whether the vehicle is stationary or moving, the manual shift mode is selected by pushing the shift lever from the D (Drive) position into the manual gate. To return to D (Drive) range operation, push the shift lever back into the main gate.

In manual shift mode, moving the shift lever backward and forward allows you to select the desired range of gears for the current driving conditions.

+ (Up) : Push the lever forward once to shift up one gear.

- (Down) : Pull the lever backwards once to shift down one gear.

i Information

- Downshifts are made automatically when the vehicle slows down.
- When the engine rpm approaches the red zone, the transmission upshifts automatically.
- If the driver pushes the lever to + (Up) or - (Down), the transmission may not shift if the next gear is outside of the allowable engine RPM range.

Shift lock system

For your safety, the Intelligent variable transmission has a shift lock system that prevents the transmission from shifting P (Park) into R (Reverse) unless the brake pedal is depressed.

To shift the transmission from P (Park) into R (Reverse):

1. Depress and hold the brake pedal.
2. Start the engine or place the ignition switch in the ON position.
3. Depress the brake pedal, press the shift release button, and put the gear in R (Reverse).

Shift lock release

If the shift lever cannot be moved from the P (Park) into R (Reverse) with the brake pedal depressed then:

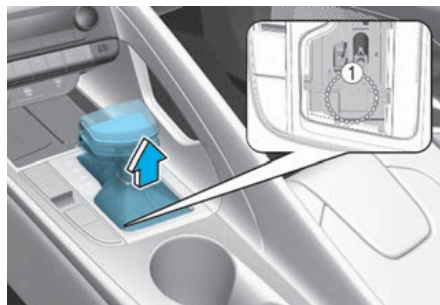

1. Place the ignition switch in the LOCK/OFF position.
2. Apply the parking brake.
3. Carefully remove the shift lever boots.
4. Move the shift lever while holding the release button (1) with a tool (e.g. flathead screw-driver).

If you need to use the shift lock release, have the vehicle inspected by an authorized HYUNDAI dealer immediately.

NOTICE

Be careful not to damage the trim around the shift lever while removing the shift lever boots.

Ignition key interlock system

 if equipped

The ignition key cannot be removed unless the shift lever is in the P (Park) position.

Parking

Always come to a complete stop and continue to depress the brake pedal. Shift the gear to the P (Park) position, apply the parking brake, and place the ignition switch in the LOCK/OFF position. Take the key with you when exiting the vehicle.



WARNING

- When you stay in the vehicle with the engine running, be careful not to depress the accelerator pedal for a long time. The engine or exhaust system may overheat and start a fire.
 - The exhaust gas and the exhaust system are very hot and may cause burns. Keep away from the exhaust system components.
 - Do not stop or park over flammable materials, such as dry grass, paper, or leaves. They may ignite and cause a fire.
-

Good driving practices

- Never shift the gear from P (Park) or N (Neutral) to any other gear when the accelerator pedal is depressed.
- Never shift the gear into P (Park) when the vehicle is moving.
- Do not shift to N (Neutral) when driving to prevent a loss of engine braking and transmission damage that may cause a collision.
- Never attempt to select a gear that is opposite the direction of the vehicle motion. Check the gear position before driving. Stop the vehicle before shifting to the desired gear. The engine may stop, causing a collision.
- Do not drive with your foot resting on the brake pedal. Even light, but consistent pedal pressure may result in the brakes overheating, brake wear, and possibly even brake failure.
- Do not hold the vehicle on an incline with the accelerator pedal. This can cause the transmission to overheat. Always use the brake pedal or parking brake.
- Always apply the parking brake when leaving the vehicle. Do not depend on placing the transmission in P (Park) to keep the vehicle from moving.
- Exercise extreme caution when driving on a slippery surface. Be especially careful when braking, accelerating, or shifting gears. On a slippery surface, an abrupt change in vehicle speed may cause the drive wheels to lose traction and may cause loss of vehicle control resulting in a collision.
- Optimum vehicle performance and economy is obtained by smoothly depressing and releasing the accelerator pedal.

 **WARNING**

To reduce the risk of serious injury or death:

- Always wear your seat belt. In a collision, an unbelted occupant is significantly more likely to be seriously injured or killed than a properly belted occupant.
 - Avoid high speeds when cornering or turning.
 - Do not make quick steering wheel movements, such as sharp lane changes or fast, sharp turns.
 - The risk of rollover greatly increases if you lose control of your vehicle at highway speeds.
 - Loss of control often occurs if two or more wheels drop off the roadway and the driver over steers to reenter the roadway.
 - In the event your vehicle leaves the roadway, do not steer sharply. Instead, slow down before pulling back into the travel lanes.
 - HYUNDAI recommends you follow all posted speed limits.
-

Dual Clutch Transmission

 if equipped

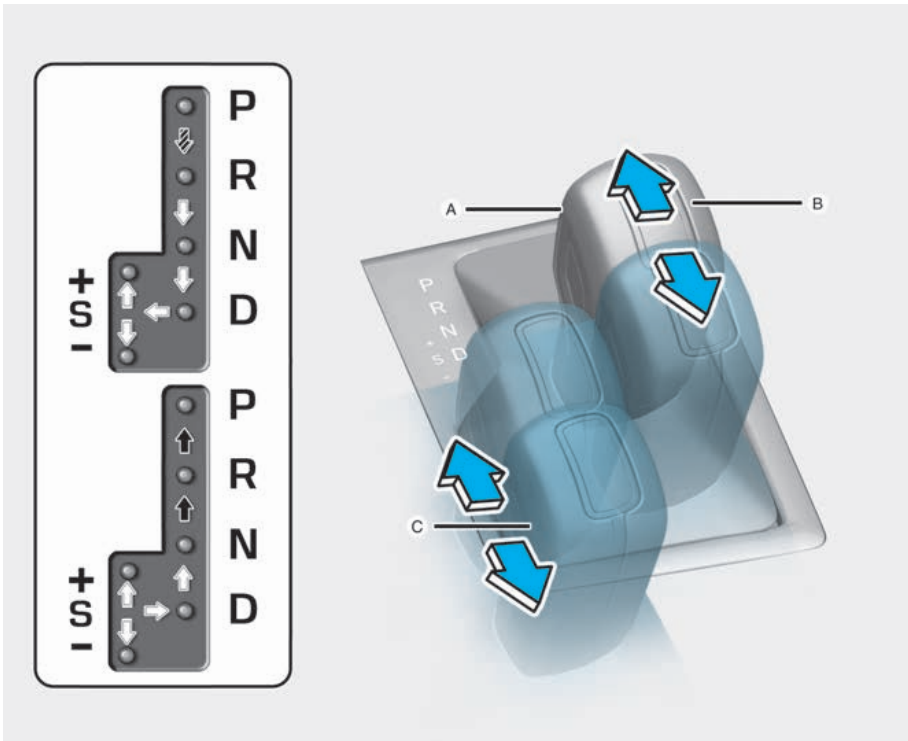

[A] Shift release button

[B] Shift lever

[C] DS mode, manual shift mode

 Depress the brake pedal and press the shift release button while moving the shift lever.

 Press the shift release button while moving the shift lever.

 The shift lever can freely operate.

Dual Clutch Transmission operation

The dual clutch transmission has 7 forward speeds and one reverse speed.

The individual speeds are selected automatically in the D (Drive) position.

The indicator on the instrument cluster the shift lever position when the ignition switch is in the ON position.

WARNING

To reduce the risk of serious injury or death:

- Always check the surrounding areas near your vehicle for people, especially children, before shifting into D (Drive) or R (Reverse).
 - Before leaving the driver's seat, always make sure the shift lever is in the P (Park) position, then apply the parking brake, and place the ignition switch in the LOCK/OFF position. Unexpected and sudden vehicle movement may occur if these precautions are not followed.
 - Do not use engine braking (using the manual shift mode or paddle shifters to shift from a higher gear to a lower gear) on slippery roads. The vehicle may lose traction with the roadway, resulting in a collision.
-
- The dual clutch transmission can be thought of as an automatically shifting manual transmission. It gives the driving feel of a manual transmission, yet provides the ease of a fully automatic transmission.
 - When D (Drive) is selected, the transmission will automatically shift through the gears similar to a conventional automatic transmission. Unlike a traditional automatic transmission, the gear shifting can sometimes be felt and heard as the actuators engage the clutches and the gears are selected.
 - The dual clutch transmission adopts a dry-type dual clutch, which is different from the torque converter of the automatic transmission. It shows better acceleration performance and increased fuel efficiency while driving but initial launch might be little bit slower than the automatic transmission.

As a result, gear shifts are sometimes more noticeable than a conventional automatic transmission and a light vibration during launching can be felt as the transmission speed. This is a normal condition of the dual clutch transmission.
 - The dry-type clutch transfers torque more directly and provides a direct drive feeling which may feel different from a conventional automatic transmission. This may be more noticeable when launching the vehicle from a stop or when traveling at low, stop-and-go vehicle speeds.
 - When rapidly accelerating at a low vehicle speed, the engine rpm may increase highly depending on the vehicle's driving condition.
 - For smooth launch uphill, press down the accelerator pedal smoothly depending on the current conditions.
 - If you release your foot from the accelerator pedal at low vehicle speed, you may feel strong engine braking, which is similar to manual transmission.

- When driving downhill, you may use Sports Mode or press the paddle shifters (if equipped) to downshift to a lower gear in order to control your speed without using the brake pedal excessively.
- When you turn the engine on and off, you may hear clicking sounds as the system goes through a self-test. This is a normal sound for the dual clutch transmission.
- During the first 1000 mi. (1,500 km), you may feel that the vehicle may not be smooth when accelerating at low speed. During this break-in period, the shift quality and performance of your new vehicle is continuously optimized.

WARNING

In case of transmission failure, you may not continue to drive and the position indicator (D, R) on the cluster will blink. Contact an authorized HYUNDAI dealer and have the system checked.

P (Park)

Always come to a complete stop before shifting into P (Park).

To shift from P (Park), depress the brake pedal firmly and make sure your foot is not depressing the accelerator pedal.

If you cannot shift the lever out of P (Park), refer to the "Shift lock release" section in this chapter if equipped with a shift lever.

WARNING

- Shifting into P (Park) while the vehicle is moving may cause you to lose control of the vehicle.
 - After the vehicle has stopped, always make sure the shift lever is in P (Park), apply the parking brake, and turn the engine off.
 - When parking on an incline, shift the gear to P (Park), apply the parking brake, and turn the wheels toward the curb to prevent the vehicle from rolling downhill.
 - Do not use the P (Park) position instead of the parking brake.
-

R (Reverse)

Use this position to drive the vehicle backward.

NOTICE

Always come to a complete stop before shifting into or out of (Reverse) to prevent damaging the transmission.

N (Neutral)

Use N (Neutral) if you need to restart a stalled engine, or if it is necessary to stop with the engine ON. Shift into P (Park) if you need to leave your vehicle for any reason.

The wheels and transaxle are not engaged.

Always depress the brake pedal when you are shifting from N (Neutral) to another gear.

D (Drive)

The transmission automatically shifts through a 7-gear sequence, providing the best fuel economy and power.

Shift to D (Drive) while depressing the brake pedal with the engine ON. Then release the brake pedal and depress the accelerator pedal.

For extra power when passing another vehicle or driving uphill, depress the accelerator fully. The transmission automatically downshifts to the next lower gear.

The DRIVE MODE switch, located on the shift lever console or on the left side of the dashboard, allows the driver to switch from NORMAL mode to SPORT or SMART mode (if equipped)

For more information, refer to the "Drive mode integrated control system" section in this chapter.

⚠ WARNING

- Do not shift into gear unless your foot is firmly on the brake pedal.
- Do not shift gears with the accelerator pedal depressed. Wait until the engine RPM is normal. The vehicle may suddenly move if you shift gears and release the brake pedal when the RPM is high.

DS (Drive Sporty) mode

To shift into DS mode, move the shift lever from D (Drive) to the center of the manual shift mode. The engine and transmission control logic is automatically optimized for sporty driving.

In DS mode, if you move the shift lever to + (Up) or - (Down), the gear changes to the manual shift mode. If the shift lever is moved back into D (Drive), it changes to D (Drive) and shifts automatically. The vehicle performs according to the mode selected from the drive mode (NORMAL, SPORT, SMART).

Manual shift mode

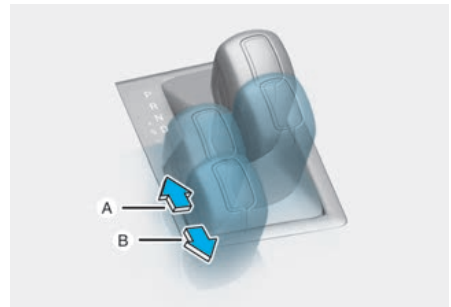

[A] + (Up)
[B] - (Down)

Whether the vehicle is stationary or moving, the manual shift mode is selected by pushing the shift lever from the D (Drive) position into the manual gate. To return to D (Drive) range operation, push the shift lever back into the main gate.

In manual shift mode, moving the shift lever backward and forward allows you to select the desired range of gears for the current driving conditions.

Up (+) : Push the lever forward once to shift up one gear.

Down (-) : Pull the lever backwards once to shift down one gear.

i Information

- Downshifts are made automatically when the vehicle slows down. When the vehicle stops, the first gear is automatically selected.
- When the engine rpm approaches the red zone, the transmission upshifts automatically.
- If the driver pushes the lever to + (Up) or - (Down), the transmission may not shift if the next gear is outside of the allowable engine RPM range.

Shift lock system

For your safety, the dual clutch transmission has a shift lock system that prevents the transmission from shifting P (Park) into R (Reverse) unless the brake pedal is depressed.

To shift the transmission from P (Park) into R (Reverse):

1. Depress and hold the brake pedal.
2. Start the engine or place the ignition switch in the ON position.
3. Depress the brake pedal. press the shift release button, and put the gear in R (Reverse).

Shift lock release

If the shift lever cannot be moved from the P (Park) into R (Reverse) with the brake pedal depressed then:

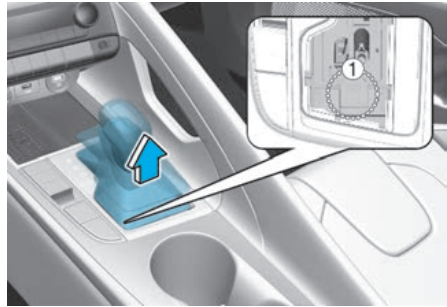

1. Place the ignition switch in the LOCK/OFF position
2. Apply the parking brake.
3. Carefully remove the shift lever boots.
4. Move the shift lever while holding the release button (1) with a tool (e.g. flathead screw-driver).

If you need to use the shift lock release, have the vehicle inspected by an authorized HYUNDAI dealer immediately.

NOTICE

Be careful not to damage the trim around the shift lever while removing the shift lever boots.

Ignition key interlock system

+ If equipped

The ignition key cannot be removed unless the shift lever is in the P (Park) position.

DCT warning messages

Transmission overheated warning

If the warning messages on the cluster continues to blink, contact an authorized HYUNDAI dealer.

Steep grade! Press brake pedal

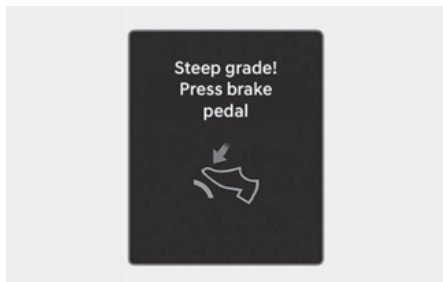

This message appears when the vehicle is driving up hills or on steep grades.

If the vehicle is held or creeping forward on an incline by applying the accelerator pedal, the clutch and transmission may result in damage.

Press the brake pedal, if the messages appears on the cluster display.

Transmission temperature is high! Stop safely

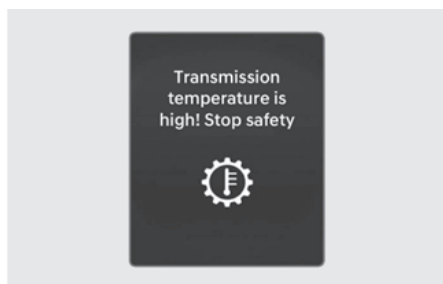

Repeated stop-and-go launches on steep grades, sudden take off or acceleration, or other harsh driving conditions may increase the clutch and transmission temperature.

If the clutch and the transmission temperature is high, the self-protection mode warns you with a warning chime and message while the shift indicator on the cluster display blinks.

- Move the vehicle to a safe location and shift the gear to P (Park) with the engine running. Wait until the transmission is sufficiently cooled down.
- If you ignore this warning, you may experience abrupt shifts, frequent shifts, or jerkiness.

Transmission hot! Park with engine On

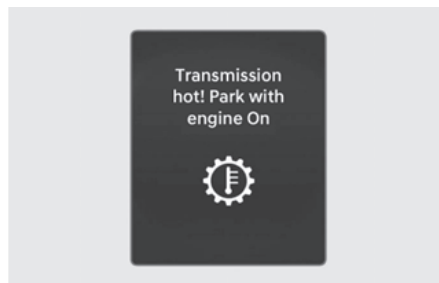

If you continue to drive with an overheated transmission, the above warning message appears, and the self-protection mode disables the clutch.

- Move the vehicle to a safe location and shift the gear to P (Park) with the engine running. Wait until the transmission is sufficiently cooled down.
- If the above warning message is displayed continuously, contact an authorized HYUNDAI dealer.

Cooling... Remain parked for 00 min.



If you move the vehicle to a safe location and shift the gear to P (Park) with the engine running, the above warning message appears.

- Wait until the clutch is sufficiently cooled down.

Transmission cooled down. Resume driving

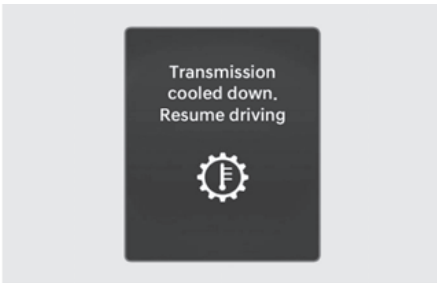

This message appears when your vehicle can be driven.

Drive the vehicle smoothly as possible.

Parking

Always come to a complete stop and continue to depress the brake pedal. Shift the gear to the P (Park) position, apply the parking brake, and place the ignition switch in the LOCK/OFF position. Take the key with you when exiting the vehicle.

! WARNING

When you stay in the vehicle with the engine running, be careful not to depress the accelerator pedal for a long time. The engine or exhaust system may overheat and start a fire.

The exhaust gas and the exhaust system are very hot and may cause burns. Keep away from the exhaust system components.

Do not stop or park over flammable materials, such as dry grass, paper, or leaves. They may ignite and cause a fire.

Paddle shifter (Manual shift mode)

 if equipped

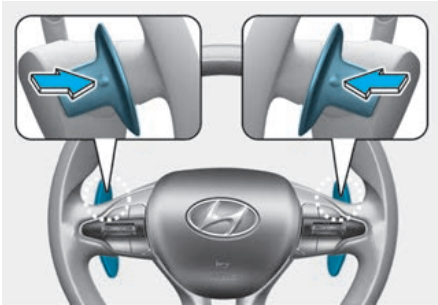

The paddle shifter is available when the gears is in the D (Drive) position.

Pull the + or - paddle shifter once to shift up or down one gear and the system changes from automatic shift mode to manual shift mode.

To change back to the automatic shift mode from manual shift mode, do one of the following:

- Gently depress the accelerator pedal for more than 5 seconds (Except Sport Mode).
- Drive the vehicle under 6 mph (10 km/h).
- Pull and hold the right side paddle shifter.

i Information

If the + and - paddle shifters are pulled at the same time, gear shift may not occur.

Good driving practices

- Never shift the gear from P (Park) or N (Neutral) to any gear when the accelerator pedal is depressed.
- Never shift the gear into P (Park) when the vehicle is moving.
- Do not shift to N (Neutral) when driving to prevent a loss of engine braking and transmission damage that may cause a collision.
- Never attempt to select a gear that is opposite the direction of the vehicle motion. Check the gear position before driving. Stop the vehicle before shifting to the desired gear. The engine may stop, causing a collision.
- Do not drive with your foot resting on the brake pedal. Even light, but consistent pedal pressure may result in the brakes overheating, brake wear, and possibly even brake failure.
- When driving in sports mode, slow down before shifting to a lower gear. Otherwise, the lower gear may not be engaged if the engine rpms are outside of the allowable range.
- Always apply the parking brake when leaving the vehicle. Do not depend on placing the transmission in P (Park) to keep the vehicle from moving.
- Exercise extreme caution when driving on a slippery surface. Be especially careful when braking, accelerating or shifting gears. On a slippery surface, an abrupt change in vehicle speed may cause the drive wheels to lose traction and may cause loss of vehicle control resulting in a collision.
- Optimum vehicle performance and economy is obtained by smoothly depressing and releasing the accelerator pedal.



WARNING

To reduce the risk of SERIOUS INJURY or DEATH:

- ALWAYS wear your seat belt. In a collision, an unbelted occupant is significantly more likely to be seriously injured or killed than a properly belted occupant.
 - Avoid high speeds when cornering or turning.
 - Do not make quick steering wheel movements, such as sharp lane changes or fast, sharp turns.
 - The risk of rollover is greatly increased if you lose control of your vehicle at highway speeds.
 - Loss of control often occurs if two or more wheels drop off the roadway and the driver over steers to reenter the roadway.
 - In the event your vehicle leaves the roadway, do not steer sharply. Instead, slow down before pulling back into the travel lanes.
 - HYUNDAI recommends you follow all posted speed limits.
-

Braking system

Power-assist brakes

Your vehicle has power-assisted brakes that adjust automatically through normal usage.

If the engine is not running or is turned off while driving, the power assist for the brakes does not work. You can still stop your vehicle by applying greater force to the brake pedal than typical. The stopping distance, however, may be longer than with power brakes.

When the engine is not running, the reserve brake power is partially depleted each time the brake pedal is depressed. Do not pump the brake pedal when the power assist has been interrupted.

i Information

- When the brake pedal is depressed under certain driving conditions or weather conditions, you may temporarily hear a noise. This is normal and does not indicate a problem with your brakes.
 - While driving on a road with deicing chemicals, brake noise or abnormal tire wear may occur due to deicing chemicals. In a safe traffic condition, additionally apply the brakes to remove deicing chemicals on the brake discs and pads.
-

WARNING

Take the following precautions:

- Do not drive with your foot resting on the brake pedal. This creates abnormal high brake temperatures, excessive brake lining and pad wear, and increased stopping distances.
- When descending down a long or steep hill, use the paddle shifter or shift lever and manually downshift to a lower gear in order to control your speed without using the brake pedal excessively. Applying the brakes continuously will cause the brakes to overheat and may result in a temporary loss of braking performance.
- Wet brakes may impair the vehicle's ability to safely slow down and the vehicle may also pull to one side when the brakes are applied. Applying the brakes lightly indicates whether they have been affected in this way. Always test your brakes in this fashion after driving through deep water. To dry the brakes, lightly tap the brake pedal to heat up the brakes while maintaining a safe forward speed until the brake performance returns to normal. Avoid driving at high speeds until the brakes function correctly.

Disc brakes wear indicator

When your brake pads are worn and new pads are required, you may hear a high pitched warning sound from your front or rear brakes. You may hear this sound come and go or it may occur whenever you depress the brake pedal.

Information

Always replace both the left and right brake pads on the front and rear axles at the same time.

Parking brake

 if equipped

Applying the parking brake

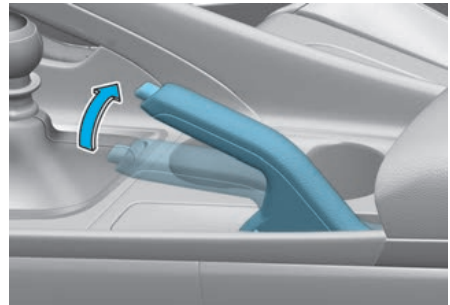

Always set the parking brake before leaving the vehicle, to apply:

Firmly depress the brake pedal.

Pull up the parking brake lever as far as possible.

WARNING

To reduce the risk of serious injury or death, do not operate the parking brake while the vehicle is moving except in an emergency situation. It may damage the brake system and cause a collision.

Releasing the parking brake

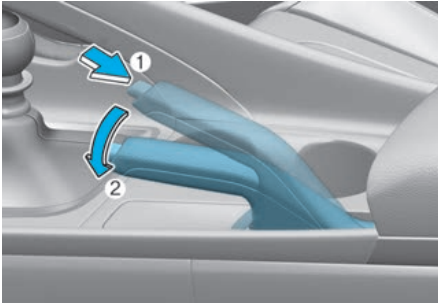

To release:

Firmly depress the brake pedal.

While pressing the release button (1), slightly pull up on the parking brake lever then lower the parking brake lever (2).

WARNING

- Whenever leaving the vehicle or parking, always come to a complete stop and continue to depress the brake pedal. Shift the vehicle into the P (Park) position, then apply the parking brake, and move the ignition switch to the LOCK/OFF position.
- Vehicles with the parking brake not fully engaged are at risk of moving inadvertently and causing serious injury to yourself or others.
- Never allow anyone who is unfamiliar with the vehicle to touch the parking brake.
- Only release the parking brake when you are seated inside the vehicle with your foot firmly on the brake pedal.

NOTICE

- Do not apply the accelerator pedal while the parking brake is engaged. If you depress the accelerator pedal with the parking brake engaged, a warning will sound. Damage to the parking brake may occur.
- Driving with the parking brake on may overheat the braking system and cause premature wear or damage to brake parts.



This light illuminates when the Parking Brake is applied with the ignition switch in the ON position or when the engine is running.

Before driving, make sure the parking brake is released and the parking brake warning light is OFF.

If the Parking Brake warning light remains on after the Parking Brake is released while the engine is running, there may be a malfunction in the brake system.

If at possible, stop driving the vehicle immediately. If that is not possible, use extreme caution while operating the vehicle and only continue to drive the vehicle until you can reach a safe location.

Electronic Parking Brake (EPB)

 if equipped

Applying the parking brake

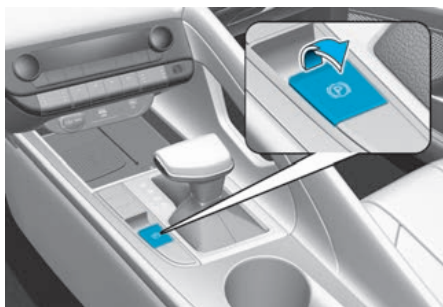

To apply EPB (Electronic Parking Brake):

1. Depress and hold the brake pedal.
2. Pull up the EPB switch.

Make sure the Parking Brake warning light comes on.

EPB (Electronic Parking Brake) may be automatically applied when:

- Requested by other systems.
- The driver turns the vehicle off while Auto Hold is operating.

Emergency braking

If there is a problem with the brake pedal while driving, emergency braking is possible by pulling up and holding the EPB switch. Braking is possible only while you are holding the EPB switch. However, braking distance may be longer than normal.

WARNING

To reduce the risk of serious injury or death, do not operate the EPB while the vehicle is moving except in an emergency situation. It may damage the brake system and cause a collision.

Information

During emergency braking, the Parking Brake warning light illuminates and you may hear a clicking noise.

NOTICE

If you notice a noise or burning smell when the EPB is used for emergency braking, have the system inspected by an authorized HYUNDAI dealer.

Releasing the parking brake

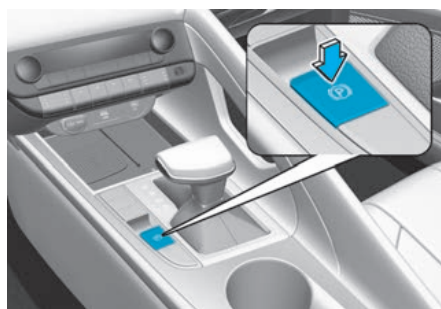

To release EPB (Electronic Parking Brake):

1. Move the ignition switch to ON or START.
2. Press the EPB switch while depressing the brake pedal.

Make sure the Parking Brake warning light goes off.

To release EPB (Electronic Parking Brake) automatically:

- Gear in P (Park) or in N (Neutral)
With the engine running, depress the brake pedal and shift out of P (Park) or N (Neutral) to R (Reverse) or D (Drive). Make sure the doors, hood, and trunk are closed and the seat belt is fastened.

i Information

- You can engage EPB even though the ignition switch is in the LOCK/OFF position (only if battery power is available), but you cannot release it.
- Depress the brake pedal and release the parking brake manually with the EPB switch before you drive downhill or when backing up.

NOTICE

- If the Parking Brake warning light is still on even though the EPB has been released, have the system inspected by an authorized HYUNDAI dealer.
- Do not drive your vehicle with EPB applied. It may cause excessive brake pad and brake rotor wear.

Warning messages

To release EPB, fasten seatbelt and close door, hood and trunk



To release EPB,
fasten seatbelt,
close door, hood,
and trunk

If the driver's seat belt is unfastened, or the hood, trunk, doors are open, and you try to drive with EPB applied, a warning sounds and a message appears.

! WARNING

To prevent serious injury or death from unintended vehicle movement:

- Always come to a complete stop and continue to depress the brake pedal before parking, shift the gear into P (Park), pull up the EPB switch, and move the ignition switch to the LOCK/OFF position. Take the key with you when leaving the vehicle.
- Never allow anyone who is unfamiliar with the vehicle to touch the EPB switch.
- Only release EPB when you are seated inside the vehicle with your foot firmly on the brake pedal.

NOTICE

Driving with the parking brake on may overheat the braking system and cause premature wear or damage to brake parts.

i Information

- In winter, the EPB related device may freeze and cannot be released. Do not use the EPB but park on a flat surface with the gear in P (Park). Use wheel chocks under the wheels if necessary. If the EPB applies automatically when the gear is shifted to P (Park), turn off the Auto Hold, and press the EPB switch to release the parking brake.
- A clicking sound may be heard while operating or releasing the EPB. These conditions are normal and indicate that EPB is functioning properly.
- When leaving your keys with a parking attendant or assistant, be sure to inform him/her how to operate the EPB.

AUTO HOLD turning Off! Press brake pedal

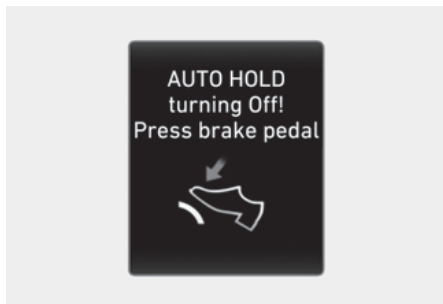

When the conversion from Auto Hold to EPB is not working properly, a warning sounds and a message appears.

Parking brake automatically engaged

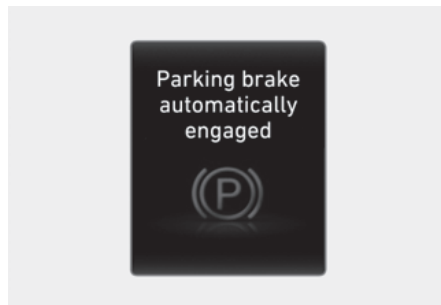

When EPB is applied while Auto Hold is activated, a warning sounds and a message appears.

EPB malfunction

Electronic Parking Brake (EPB) warning light illuminates if the ignition switch is in the ON position and goes off in about 3 seconds if the system is operating normally.

If the EPB warning light remains on, comes on while driving, or does not come on when the ignition switch is ON, the EPB may have malfunctioned.

If this occurs, have the system inspected by an authorized HYUNDAI dealer.

The EPB warning light may illuminate when the ESC indicator light comes on to indicate that ESC is not working properly, but it does not indicate a malfunction of EPB.

NOTICE

- If the Parking Brake warning light does not illuminate or blinks after the EPB switch has been pulled, the EPB may not be applied.
- If the EPB warning light is still on or the Parking Brake warning light blinks when the EPB warning light is on, press the switch, and then pull it up. Repeat this one more time. If the EPB warning does not go off, have your vehicle towed on a flatbed tow truck to an authorized HYUNDAI dealer.

Parking brake warning light



This light illuminates when the Parking Brake is applied with the ignition switch in the ON position or when the engine is running.

Before driving, make sure the parking brake is released and the parking brake warning light is OFF.

If the Parking Brake warning light remains on after the Parking Brake is released while the engine is running, there may be a malfunction in the brake system.

If possible, stop driving the vehicle immediately. If that is not possible, use extreme caution while operating the vehicle and only continue to drive the vehicle until you can reach a safe location.

Auto Hold

If equipped

Auto Hold maintains the vehicle in a standstill even though the brake pedal is not depressed after the driver brings the vehicle to a complete stop by depressing the brake pedal.

To apply:

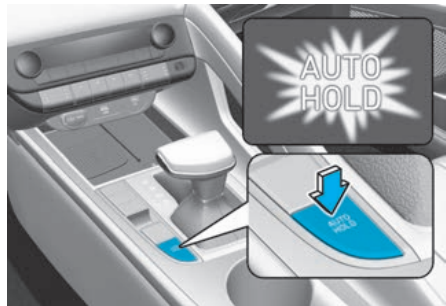

1. Press the AUTO HOLD switch. The white AUTO HOLD indicator comes on and the system is in standby.

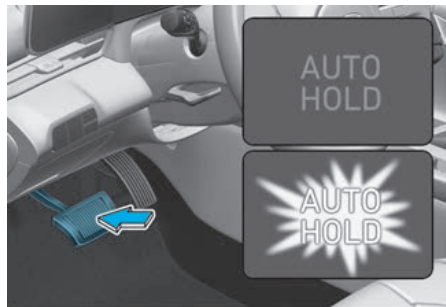

2. When you stop the vehicle completely by depressing the brake pedal, Auto Hold maintains the brake pressure to hold the vehicle stationary. The indicator changes from white to green. The vehicle remains stationary even if you release the brake pedal.

To release:

If you depress the accelerator pedal with the gear in D (Drive) or manual shift mode or R (Reverse), the Auto Hold is released automatically and the vehicle starts to move. The AUTO HOLD indicator changes from green to white.

⚠ WARNING

Always look around your vehicle before depressing the accelerator pedal to release Auto Hold.

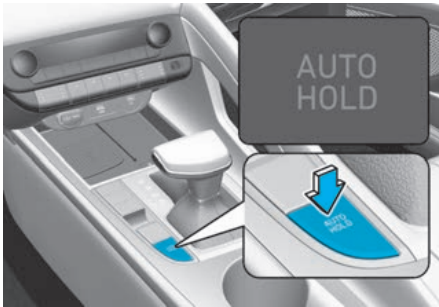
To cancel:

1. Depress and hold the brake pedal.
2. Press the AUTO HOLD switch.

The AUTO HOLD indicator turns off.

⚠ WARNING

To prevent unintended vehicle movement, always depress your foot on the brake pedal to cancel the Auto Hold before you:

- Drive downhill.
- Drive the vehicle in R (Reverse).
- Park the vehicle.

i Information

- The Auto Hold does not operate when:
 - The gear is in P (Park).
 - The gear is in R (Reverse).
 - EPB is applied.
- The Auto Hold automatically switches to EPB when:
 - The driver's door or hood is opened.
 - The vehicle is in a standstill for more than 10 minutes.
 - The vehicle is on a steep slope.
 - The vehicle moves several times.
 - The trunk is opened.

The Parking Brake warning light comes on, the AUTO HOLD indicator changes from green to white, and a warning sounds and a message appears to inform you that EPB has been automatically engaged. Before driving, depress the brake pedal, check the surrounding area, and release the parking brake manually with the EPB switch.

NOTICE

If the AUTO HOLD indicator changes to yellow, Auto Hold does not work properly. Contact an authorized HYUNDAI dealer.

Warning messages

Parking brake automatically engaged

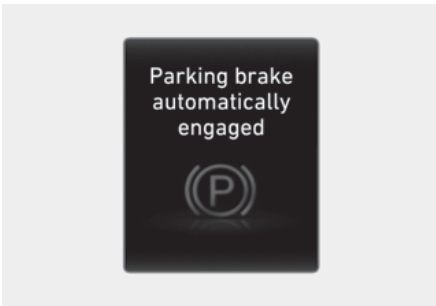

When EPB is applied while Auto Hold is activated, a warning sounds and a message appears.

Press brake pedal to deactivate AUTO HOLD

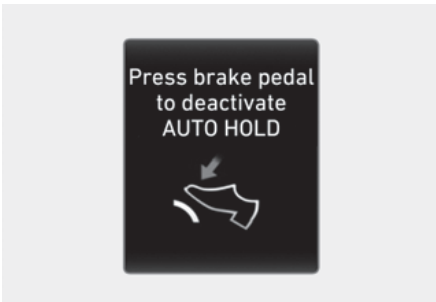

If you did not apply the brake pedal when you release Auto Hold by pressing the AUTO HOLD switch, a warning sounds and a message appears.

AUTO HOLD turning Off! Press brake pedal

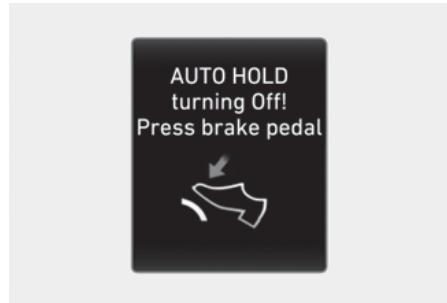

When the conversion from Auto Hold to EPB is not working properly, a warning sounds and a message appears.

Anti-lock Brake System (ABS)

WARNING

Anti-Lock Braking System (ABS) or Electronic Stability Control (ESC) system will not prevent accidents due to improper or dangerous driving maneuvers. Even though vehicle control is improved during emergency braking, always maintain a safe distance between you and objects ahead of you. Always reduce the vehicle speed in extreme road conditions.

The braking distance for vehicles equipped with ABS or ESC may be longer than for those without these systems in the following road conditions:

- Rough, gravel, or snow-covered roads.
- On roads where the road surface is pitted or has different surface height.
- Tire chains are installed on your vehicle.

Never test the safety features of an ABS or ESC equipped vehicle by high speed driving or cornering. It may cause a collision and endanger the safety of yourself or others.

ABS is an electronic braking system that helps prevent a braking skid. ABS allows the driver to steer and brake at the same time.

Using ABS

To obtain the maximum benefit from your ABS in an emergency situation, do not attempt to modulate your brake pressure and do not try to pump your brakes. Depress your brake pedal as hard as possible.

When you apply your brakes under conditions that may lock the wheels, you may hear sounds from the brakes, or feel a corresponding sensation in the brake pedal. This is normal and it means your ABS is active.

ABS does not reduce the time or distance to stop the vehicle.

Always maintain a safe distance from the vehicle in front of you.

ABS does not prevent a skid that results from sudden changes in direction, such as trying to take a corner too fast or making a sudden lane change. Always drive at a safe speed for the road and weather conditions.

ABS cannot prevent a loss of stability. Always steer moderately when braking hard. Severe or sharp steering wheel movement can still cause your vehicle to veer into oncoming traffic or off the road.

On loose or uneven road surfaces, operation of the anti-lock brake system may result in a longer stopping distance than for vehicles equipped with a conventional brake system.

The ABS ((ABS)) warning light stays on for several seconds after the ignition switch is in the ON position.

During that time, ABS goes through self-diagnosis and the light goes off if everything is normal. If the light stays on, contact an authorized HYUNDAI dealer as soon as possible.

WARNING

If the ABS ((ABS)) warning light is on and stays on, you may have a problem with the ABS. Your power brakes work normally. To reduce the risk of serious injury or death, contact your authorized HYUNDAI dealer as soon as possible.

Information

When you drive on a road having poor traction, such as an icy road, and apply your brakes continuously, ABS is active continuously and the ABS ((ABS)) warning light may illuminate. Pull your vehicle over to a safe place and turn off the vehicle.

Restart the vehicle. If the ABS warning light is off, your ABS system is normal.

If not, contact an authorized HYUNDAI dealer as soon as possible.

Information

When you jump start your vehicle because of a drained battery, the ABS ((ABS)) warning light may turn on at the same time. It does not mean your ABS is malfunctioning. Have the battery recharged before driving the vehicle.

Electronic Stability Control (ESC)

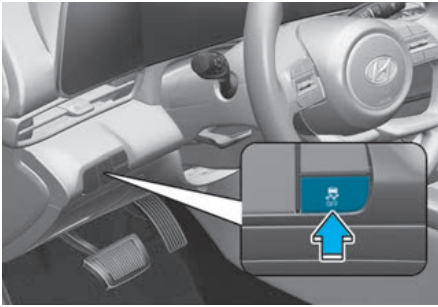

Electronic Stability Control helps stabilize the vehicle during cornering maneuvers. ESC checks where you are steering and where the vehicle is actually going. ESC applies braking pressure to any one of the vehicle's brakes and intervenes in the engine management system to assist the driver with keeping the vehicle on the intended path. It is not a substitute for safe driving practices. Always adjust your speed and driving to the road conditions.

WARNING

Never drive too fast for the road conditions when cornering. ESC does not prevent a collision.

Excessive speed in turns, abrupt maneuvers, and hydroplaning on wet surfaces may result in severe collisions.

ESC operation

ESC ON condition

When the ignition switch is in the ON position, ESC and the ESC OFF indicator lights illuminate for about three seconds. After both lights go off, ESC is enabled.

When operating



When ESC is operating, the ESC indicator light blinks:

- When you apply your brakes under conditions that may lock the wheels, you may hear sounds from the brakes, or feel a corresponding sensation in the brake pedal.
- If Cruise Control has been used when ESC activates, Cruise Control automatically disengages. Refer to the "Cruise Control (CC)" section in chapter 7 (if equipped).
- When moving out of the mud or driving on a slippery road, the engine RPM (revolutions per minute) may not increase even if you depress the accelerator pedal all the way. This is to maintain the stability and traction of the vehicle and does not indicate a problem.

ESC OFF condition



OFF

To cancel ESC operation:

- State 1

Press the ESC OFF button briefly. The ESC OFF indicator light and the message, "Traction Control disabled" illuminate.

The traction control function of ESC (engine management) is disabled, but the brake control function of ESC (braking management) still operates.

- State 2

Press and hold the ESC OFF button continuously for more than 3 seconds. The ESC OFF indicator light and the message, "Traction & Stability Control disabled" illuminate and a warning chime sounds. Both the traction control function of ESC (engine management) and the brake control function of ESC (braking management) are disabled.

If the ignition switch is moved to the LOCK/OFF position when ESC is off, ESC remains off. Upon restarting the vehicle, ESC automatically turns on again.

Indicator lights

- ESC indicator light (blinks)



- ESC OFF indicator light (comes on)



When the ignition switch is in the ON position, the ESC indicator light illuminates, then goes off if the ESC system is operating normally.

The ESC indicator light blinks whenever ESC is operating.

If the ESC indicator light stays on, have your vehicle inspected by an authorized HYUNDAI dealer as soon as possible.

The ESC OFF indicator light comes on when ESC is turned off.

WARNING

When ESC is blinking, this indicates ESC is active:

- Drive slowly and Never attempt to accelerate.
- Never turn off ESC while the ESC indicator light is blinking. You may lose control of the vehicle and collide.

i Information

Driving with wheels and tires with different sizes may cause the ESC system to malfunction. Before replacing tires, make sure all four tires and wheels are the appropriate size for your vehicle. Never drive the vehicle with different sized wheels and tires installed.

ESC OFF usage

When Driving

The ESC OFF mode should only be used briefly to help free the vehicle if stuck in snow or mud, by temporarily stopping operation of ESC, to maintain wheel torque.

To turn off ESC while driving, press the ESC OFF button while driving on a flat road surface.

NOTICE

To prevent damage to the transmission:

- Do not allow wheel(s) of one axle to spin excessively while the ESC, ABS, and Parking Brake warning lights appear. The repairs would not be covered by the vehicle warranty. Reduce engine power and do not spin the wheel(s) excessively while these lights appear.
 - When operating the vehicle on a dynamometer, make sure ESC is turned off (ESC OFF light illuminated).
-

i Information

Turning ESC off does not affect ABS or standard brake system operation.

Vehicle Stability Management (VSM)

Vehicle Stability Management is a function of the Electronic Stability Control (ESC) system. It helps the vehicle stay stable when accelerating or braking suddenly on wet, slippery, and rough roads where traction over the four tires can suddenly become uneven.

! WARNING

VSM is not a substitute for safe driving practices. To prevent serious injury or death:

- Always monitor the speed and the distance to the vehicle ahead of you.
 - Never drive too fast for the road conditions. Excessive speed in bad weather or on slippery and uneven roads may result in severe collisions.
-

VSM operation

The VSM operates when:

- Vehicle speed is approximately above 9 mph (15 km/h) on curve roads.
- Vehicle speed is approximately above 12 mph (20 km/h) when the vehicle is braking on rough roads
- The Electronic Stability Control (ESC) is on.

When operating

When you apply your brakes under conditions that can activate ESC, you may hear sounds from the brakes, or feel a corresponding sensation in the brake pedal. This is normal and it means your VSM is active.

i Information

VSM does not operate when:

- Driving on a banked road such as gradient or incline.
- Driving in reverse.
- The ESC OFF indicator light is on.
- The MDPS (Motor Driven Power Steering) warning light (⚠) is on or blinks.

VSM OFF condition

To cancel VSM operation, press the ESC OFF button. ESC OFF (OFF) indicator light illuminates.

To turn on VSM again, press the ESC OFF button again. The ESC OFF indicator light goes out.

WARNING

If the ESC (⚠) indicator light or MDPS (⚠) warning light stays illuminated or blinks, your vehicle may have a malfunction with the VSM system. Have the vehicle inspected by an authorized HYUNDAI dealer as soon as possible.

Hill-start Assist Control (HAC)

Hill-Start Assist Control helps prevent the vehicle from rolling backwards when starting from a stop on a hill.

WARNING

Always be ready to depress the accelerator pedal when starting from a stop on an uphill slope. Hill-Start Assist Control activates only for about 2 seconds.

i Information

- Hill-Start Assist Control does not operate when the gear is shifted to P (Park) or N (Neutral).
- Hill-Start Assist Control activates even when the ESC (Electronic Stability Control) is off. It does not activate, if the ESC is not operating normally.

Good braking practices

WARNING

Whenever leaving the vehicle or parking, always come to a complete stop and continue to depress the brake pedal. Shift the gear to the P (Park) position, apply the parking brake, and move the ignition switch to the LOCK/OFF position.

Vehicles parked with the parking brake not applied or not in P (Park) may roll inadvertently and may cause injury to the driver and others. ALWAYS apply the parking brake before exiting the vehicle.

Wet brakes can be dangerous! The brakes may get wet if the vehicle is driven through standing water or if it is washed. Your vehicle may not stop quickly if the brakes are wet. Wet brakes may cause the vehicle to pull to one side.

To dry the brakes, apply the brakes lightly until the braking action returns to normal. If the braking action does not return to normal, stop as soon as it is safe to do so and contact an authorized HYUNDAI dealer for assistance.

DO NOT drive with your foot resting on the brake pedal. Even light, but constant pedal pressure may result in the brakes overheating, brake wear, and possibly even brake failure.

If a tire goes flat while you are driving, apply the brakes gently and keep the vehicle pointed straight ahead while you are slowing down. When you are moving slowly enough for it to be safe to do so, pull off the road and stop in a safe location.

Keep your foot firmly on the brake pedal when the vehicle is stopped to prevent the vehicle from rolling forward.

Idle Stop and Go (ISG) system

 If equipped

The Idle Stop and Go (ISG) system reduces fuel consumption by automatically shutting down the engine when the vehicle is at a standstill. (e.g. red light and traffic jam)

The engine starts automatically as soon as the starting conditions are met.

The ISG is ON whenever the engine is running.

Information

When the engine automatically starts by the ISG system, some warning lights (ABS, ESC, ESC OFF, EPS or Parking brake warning light) may turn on for a few seconds.

This happens because of low battery voltage. It does not mean the system has malfunctioned.

Auto stop

If you depress the brake pedal and the vehicle comes to a stop with the ISG ON, the engine will stop automatically.

Stop the vehicle completely by pressing the brake pedal when the gear is in the D (Drive) or N (Neutral) position.



The engine will stop and the green Auto Stop ((A)) indicator on the instrument cluster will appear.

NOTICE

If you open the engine hood in auto stop mode, the following will happen:

- Auto Stop is Off. Shift to P or N and start engine manually



- The ISG system will deactivate.
- The ISG system will deactivate

- Press brake pedal for Auto Start

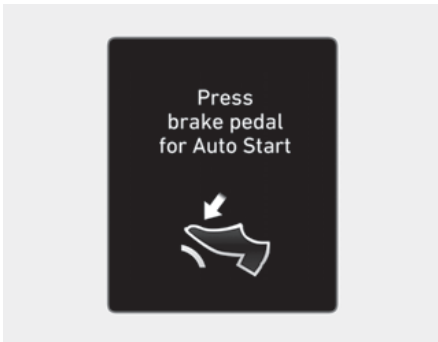

If you shift the gear from N to D (Manual mode) or R without depressing the brake pedal after stopping engine automatically, the engine does not restart automatically and a warning chime alarms. When this happens, press the brake pedal for auto start.

Auto start

When the engine stops automatically by ISG, the engine will restart if the driver takes one of the following actions:

- Releases the brake pedal.
- Moves the shift gear to the R(Reverse) position or the Manual mode while depressing the brake pedal.

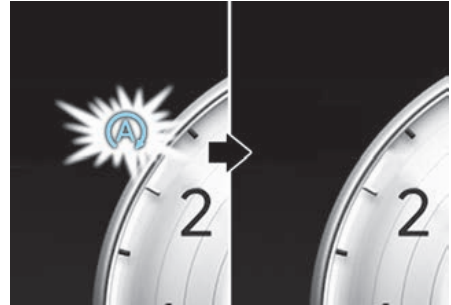

The engine will start and the green Auto Stop indicator ((A)) on the instrument cluster will change to white.

The engine will also restart automatically without any driver actions if the following occurs:

- The brake vacuum pressure is low.
- The engine has stopped for about 5minutes.
- The air conditioning is ON with the fan speed set to the highest position.
- The front defroster is ON.
- The battery is weak.
- The cooling and heating performance of the climate control system is unsatisfactory.
- The vehicle is shifted to P (Park) when Auto Hold is activated. (if equipped with Auto Hold)
- The door is opened or the seatbelt is unfastened when Auto Hold is activated. (if equipped with Auto Hold)
- The EPB switch is pressed when Auto Hold is activated. (if equipped with Auto Hold)

Operating conditions

The ISG will operate under the following condition:

- The driver's seatbelt is fastened.
- The driver's door and hood are closed.
- The brake vacuum pressure is adequate.
- The battery sensor is activated and the battery is sufficiently charged.
- Outside temperature is not too low or too high.
- The vehicle is driven over a constant speed and stops.
- The climate control system satisfies the conditions.
- The vehicle is sufficiently warmed up.
- The incline is gradual.
- The steering wheel is turned less than 180 degrees and then the vehicle stops.

NOTICE

- If the ISG system does not meet the operation condition, the ISG system is deactivated. If the ISG does not operate, the reason for the non-operation will appear on the cluster display.
- If the light or warning message comes on continuously, please check the operation condition.
- ISG system will be activated with the vehicle equipped with Smart Cruise Control if the operating conditions are met.

Deactivating the ISG

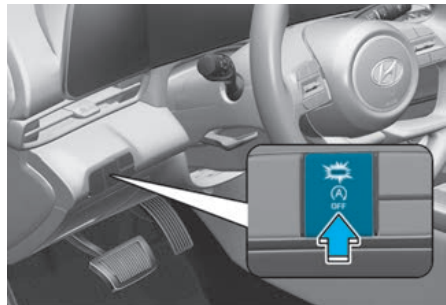

- If you wish to deactivate the ISG, press the ISG OFF button. The light on the ISG OFF button will illuminate.
- If you press the ISG OFF button again, the ISG will be activated and the light on the ISG OFF button will turn off.

ISG malfunction



The ISG may not operate when an ISG related sensor or system error occurs. The following will happen:

- The yellow AUTO STOP (A) indicator on the instrument cluster will appear.

When the engine is in Idle Stop mode, it's possible to restart the engine without the driver taking any action.

Before leaving the vehicle or doing anything in the engine compartment, stop the engine by the Push Button Start ignition switch to the OFF position.

NOTICE

If the AGM battery is reconnected or replaced, ISG function will not operate immediately. If you want to use the ISG function, the battery sensor needs to be calibrated for approximately 4 hours with the ignition off. After calibration, turn the engine on and off 2 or 3 times.

Smart ISG features

Early Engine Restart

If the engine was stopped automatically by ISG, Early Engine Restart can automatically restart the engine from ISG without driver action when the vehicle ahead pulls away and the front view camera detects the preceding vehicle's movement.

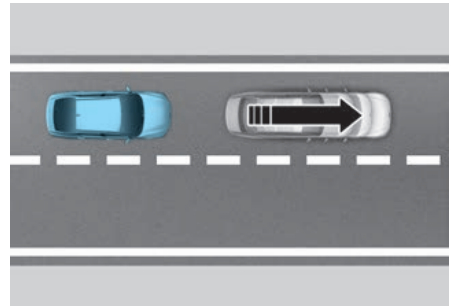

If the engine restarts automatically by the Early Engine Restart function, a message will appear on the cluster display when the "AUTO STOP" page on the instrument cluster is selected.

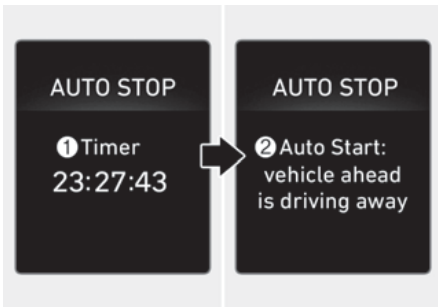

- (1) Timer
- (2) Auto Start: vehicle ahead is driving away

NOTICE

- Even when the preceding vehicle drives away, the Early Engine Restart function may not restart the engine in case of limitations of the front view camera which can detect the preceding vehicle's movement.
- Regarding the limitations of the front view camera, please refer to Limitations of Smart ISG features.
- If the engine was turned off by ISG, it can be restarted anytime by releasing the brake pedal, regardless of Early Engine Restart.

ISG inhibition at traffic signs (STOP/YIELD/Roundabout)

ISG inhibition at traffic signs can deactivate the ISG system and keep the engine on when stopped at certain traffic signs (STOP/YIELD/Roundabout).

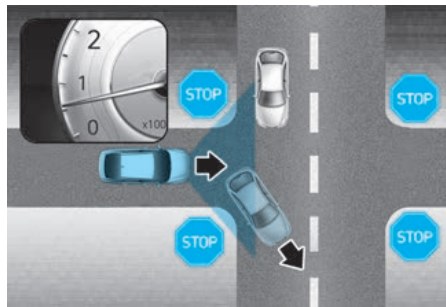

If a STOP, YIELD or Roundabout sign is detected and the ISG system is deactivated by ISG inhibition at traffic signs, a message will appear on the cluster display (if equipped) when the "AUTO STOP" page on the instrument cluster is selected.

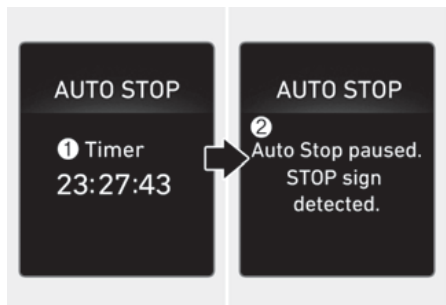
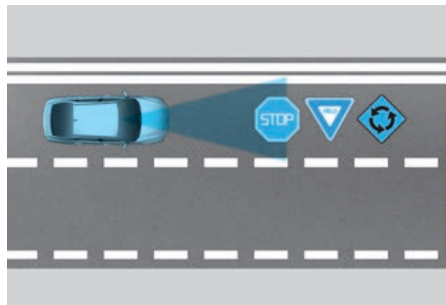

- (1) Timer
- (2) Auto Stop paused. STOP sign detected

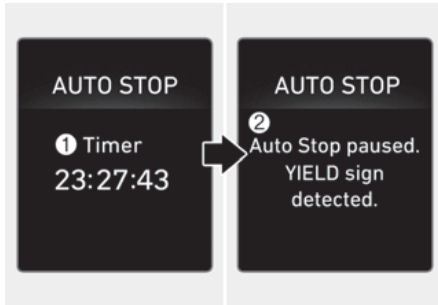

- (1) Timer
- (2) Auto Stop paused. YIELD sign detected

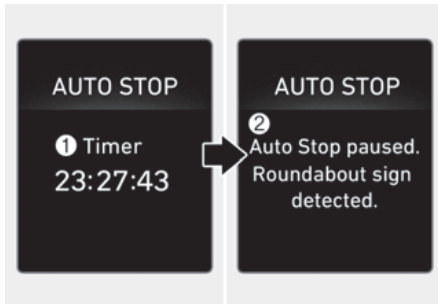

- (1) Timer
- (2) Auto Stop paused. Roundabout sign detected

NOTICE

- Even when stopped at a STOP, YIELD, or Roundabout sign, this feature may not deactivate the ISG system in case of limitations of the front view camera which is able to detect traffic signs ahead.
- Regarding the limitations of the front view camera, please refer to Limitations of Smart ISG features.

ISG inhibition from turn signal

ISG inhibition from turn signal can deactivate the ISG system and keep the engine on when the turn signal is on and the front view camera does not detect a preceding vehicle.

If the ISG system is deactivated by ISG inhibition from turn signal, a message will appear on the cluster display when the "AUTO STOP" page on the instrument cluster is selected.

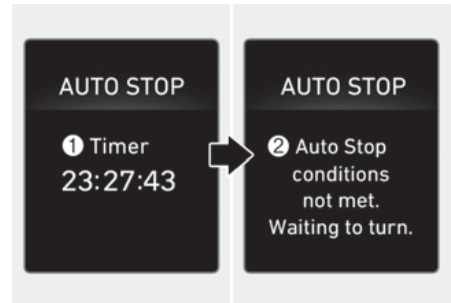

- (1) Timer
- (2) AUTO STOP conditions not met. Waiting to turn.

If the ISG system has been deactivated by ISG inhibition from turn signal and the vehicle has not moved for 12 seconds, then the engine will shutdown automatically to reduce fuel consumption if all Operation Conditions are met.

NOTICE

- Even when stopped with the turn signal on, this feature may not deactivate the ISG system in case of limitations of the front view camera.
- Regarding the limitations of the front view camera, please refer to Limitations of Smart ISG features.



WARNING

Limitations of Smart ISG features

- Smart ISG features may not operate normally, or may operate unexpectedly, under the following circumstances:
 - The detecting sensor or the surroundings are contaminated or damaged
 - The temperature around the front view camera is high or low due to surrounding environment
 - The camera lens is contaminated due to tinted, filmed or coated windshield, damaged glass, or sticky foreign material (sticker, bug, etc.) on the glass
 - Moisture is not removed or frozen on the windshield
 - Driving in heavy rain or snow, or thick fog
 - The field of view of the front view camera is obstructed by sun glare
 - Street light or light from an oncoming vehicle is reflected on the wet road surface, such as a puddle on the road
 - Your vehicle is being towed
 - The surroundings are very bright
 - The surroundings are very dark.
 - The brightness changes suddenly (e.g. when entering or exiting a tunnel)
 - The brightness outside is low, and the headlamps are not on or are not bright
 - Only part of the vehicle is detected
 - The vehicle in front is a bus, heavy truck, truck with a unusually shaped luggage, trailer, etc.
 - The vehicle in front has no tail lights, tail lights are located unusually, etc.
 - The rear of the front vehicle is small or the vehicle does not look normal, such as when the vehicle is tilted, overturned, or the side of the vehicle is visible, etc.
 - The front vehicle's ground clearance is low or high
 - A vehicle, pedestrian or cyclist suddenly cuts in front
 - The vehicle in front is detected late
 - The vehicle in front is suddenly blocked by an obstacle
 - The vehicle in front suddenly changes lane or suddenly reduces speed
 - The vehicle in front is bent out of shape
 - The vehicle in front steers in the opposite direction of your vehicle to avoid a collision
 - With a vehicle in front, your vehicle changes lane at low speed
 - The vehicle in front is covered with snow
 - You are departing or returning to the lane
 - Unstable driving
 - You are on a roundabout and the vehicle in front is not detected
 - You are continuously driving in a circle
 - The vehicle in front has an unusual shape
 - Some traffic signs may not be detected by the front view camera under the following circumstances:
 - If located uphill or downhill away from the vehicle
 - If located multiple lanes away from the vehicle
 - If partially or entirely blocked or covered by another vehicle, tree, or any obstacles
 - If damaged or alternated by stickers, graffiti, etc.
 - If turned away from the vehicle
-

Drive mode integrated control system

 if equipped

Selecting drive mode

Type A



Type B (N Line)

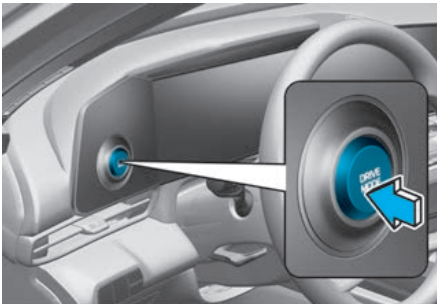

The drive mode can be selected according to the driver's preference or road condition.

i Information

If there is a problem with the instrument cluster, the drive mode will be in NORMAL mode and may not change to SPORT mode.

The mode changes whenever the DRIVE MODE button is pressed.

- NORMAL ↔ SPORT ↔ SMART

When the NORMAL mode is selected, it does not appear on the instrument cluster.

The drive mode will change to NORMAL mode when the engine is restarted. However, except when it is in SMART mode. SMART mode will be maintained, as selected when the engine is restarted.

If you change the setting of the drive mode integrated control mode, SCC reaction of Smart Cruise Control is also changed. (if equipped)

| Drive mode integrated control mode | SCC reaction |
|------------------------------------|--------------|
| NORMAL | Normal |
| SPORT | Fast |
| SMART | Normal |

NORMAL, SPORT, SMART mode features

NORMAL mode

NORMAL mode provides smooth driving and comfortable riding.

SPORT mode

SPORT

SPORT mode provides sporty response. In SPORT mode, the fuel efficiency may decrease.

- When the SPORT mode is selected, the SPORT indicator illuminates on the instrument cluster.
- When the SPORT mode is activated:
 - The engine RPM tends to remain raised over a certain time even after releasing the accelerator pedal.
 - Upshifts are delayed when accelerating.

SMART mode

SMART

SMART mode selects the proper driving mode between NORMAL, and SPORT by judging the driver's driving habits (mild or dynamic) from the brake pedal depression or the steering wheel operation.

- When the SMART mode is selected, the SMART indicator illuminates on the instrument cluster.
- The vehicle starts in SMART mode, when the engine has been turned OFF in SMART mode.

i Information

- When using the SMART mode, if your acceleration pedal input is gradual, the drive mode maximizes the fuel efficiency.
- When your vehicle is in SMART mode and your driving style is more aggressive so that your acceleration pedal input is more abrupt, the drive mode changes to reflect a more SPORT driving characteristic.

Various driving situations, which you may encounter in SMART mode

- The driving mode automatically changes to SMART SPORT, when you abruptly accelerate the vehicle or repetitively operate the steering wheel. In this mode, your vehicle drives in a lower gear for abrupt accelerating/decelerating and increases the engine brake performance.
- You may still sense the engine brake performance, even when you release the accelerator pedal in SMART SPORT mode. It is because your vehicle remains to be in a lower gear over a certain period of time for next acceleration.
- The driving mode automatically changes to SMART SPORT mode only in harsh driving conditions. In most driving situations, the driving mode is set to SMART NORMAL mode.
- The driving mode automatically changes to SMART NORMAL mode with the same driving patterns, when the vehicle starts to drive on an upward slope of a certain angle.

SMART mode deactivates automatically

SMART mode may deactivate if:

- The driver manually shifts gears.
- Cruise Control may deactivate the SMART mode. When a higher speed is set by Cruise Control, it starts to control the vehicle speed and deactivates the SMART mode.
- Extremely high/low transmission oil temperatures may temporarily deactivate the SMART mode, because the transmission is outside its normal operating condition.

Smart shift on trip computer

 if equipped

Select the Trip Computer mode  on the instrument cluster and move to the smart shift screen. Then, the driver can see the drive mode selected and the drive mode which is automatically switched by the SMART mode.

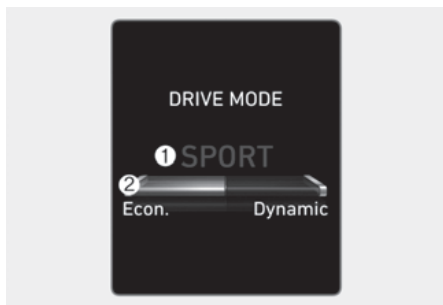

The drive mode selected by the driver (1) and the driving style gauge (2) showing the driver's driving style are displayed on the screen.

Special driving conditions

Hazardous driving conditions

When hazardous driving conditions are encountered such as water, snow, ice, mud, and sand:

- Drive cautiously and allow for longer braking distances.
- Avoid abrupt braking or steering.
- If your vehicle is stuck in snow, mud, or sand, use the second gear. Accelerate slowly to avoid unnecessary wheel spin.
- Put sand, rock salt, tire chains, or other non-slip materials under the wheels to provide additional traction if stuck in ice, snow, or mud.

WARNING

Downshifting with an automatic transmission while driving on slippery surfaces may cause an accident. The sudden change in tire speed may cause the tires to skid. Be careful when downshifting on slippery surfaces.

Rocking the vehicle

If it is necessary to rock the vehicle to free it from snow, sand, or mud, first turn the steering wheel right and left to clear the area around your front wheels. Then, shift back and forth between R (Reverse) and a forward gear.

Try to avoid spinning the wheels, and do not race the engine.

To prevent transmission wear, wait until the wheels stop spinning before shifting gears. Release the accelerator pedal while shifting, and press lightly on the accelerator pedal while the transmission is in gear. Slowly spinning the wheels in forward and reverse directions causes a rocking motion that may free the vehicle.



WARNING

Always turn off the ESC system before rocking the vehicle. If the vehicle is stuck and excessive wheel spin occurs, the temperature in the tires may increase very quickly. If the tires become damaged, a tire blow out or tire explosion may occur - you and others may be injured. Do not attempt this procedure if people or objects are near the vehicle.

If you attempt to free the vehicle, the vehicle may overheat quickly, possibly causing an engine compartment fire or other damage. Try to avoid spinning the wheels as much as possible to prevent overheating of the tires or the engine. DO NOT allow the vehicle to spin the wheels above 35 mph (56 km/h).

If you are still stuck after rocking the vehicle a few times, have the vehicle pulled out by a tow vehicle to avoid engine overheating, possible damage to the transmission, and tire damage. Refer to the "Towing" section in chapter 8.

Smooth cornering

Avoid braking or gear changing in corners, especially when roads are wet. Ideally, cornering should be taken under gentle acceleration.

Driving at night

Night driving presents more hazards than driving in the daylight. Here are some important tips to remember:

- Slow down and keep more distance between you and other vehicles, because it may be more difficult to see at night, especially in areas where there are no street lights.
- Adjust your mirrors to reduce the glare from other drivers' headlights.

- Keep your headlights clean and properly aimed. Dirty or improperly aimed headlights can make it much more difficult to see at night.
- Avoid staring directly at the headlights of oncoming vehicles. You may be temporarily blinded, and it takes several seconds for your eyes to readjust to the darkness.

Driving in the rain

Rain and wet roads can make driving dangerous. When driving in the rain or on slick pavement:

- Slow down and allow extra following distance. A heavy rainfall makes it harder to see and increases the distance needed to stop your vehicle.
- Turn OFF your Cruise Control. (if equipped)
- Replace your windshield wiper blades when they show signs of streaking or missing areas on the windshield.
- Make sure your tires have enough tread. If your tires do not have enough tread, making a quick stop on wet pavement may cause a skid and possibly lead to a collision. Refer to the "Tires and wheels" section in chapter 9.
- Turn on your headlights to make it easier for others to see you. Using your headlights when using your windshield wipers is required in some jurisdictions.
- Driving too fast through large puddles may affect your brakes. If you must go through puddles, try to drive through them slowly.
- If you believe your brakes are wet, apply them several times while the vehicle is moving slowly.

Hydroplaning

If the road is wet enough and you are driving fast enough, your vehicle may have little or no contact with the road surface and actually ride on the water. The best advice is SLOW DOWN when the road is wet.

The risk of hydroplaning increases as the depth of tire tread decreases, refer to the "Tires and wheels" section in chapter 9.

Driving in flooded areas

Avoid driving through flooded areas unless you are sure the water is not deeper than the bottom of the wheel hub. If you are not sure, turn around and find a different route.

Drive through any water slowly. Allow adequate stopping distance because the brake performance can be reduced.

After driving through water, dry the brakes by gently applying them several times while the vehicle is moving slowly.

Highway driving

Tires

Adjust the tire inflation pressure, as specified. Under-inflation may overheat or damage the tires.

Do not install worn-out or damaged tires, which may reduce traction or fail.

i Information

Never over-inflate your tires above the maximum inflation pressure, as specified on your tires.

Fuel, engine coolant and engine oil

Driving at higher speeds on the highway consumes more fuel and is less efficient than driving at a slower, more moderate speed. Maintain a moderate speed to conserve fuel when driving on the highway.

Check both the engine coolant level and the engine oil before driving.

Drive belt

A loose or damaged drive belt may overheat the engine.

Winter driving

Snow or icy conditions

You need to keep sufficient distance between your vehicle and the vehicle in front.

Apply the brakes gently. Speeding, rapid acceleration, sudden brake applications, and sharp turns are very hazardous practices. When decelerating, use engine braking to the fullest extent. Sudden brake applications on snowy or icy roads may cause the vehicle to skid.

To drive your vehicle in deep snow, it may be necessary to use snow tires or to install tire chains on your tires.

Always carry emergency equipment. You may want to carry tire chains, tow straps or chains, a flashlight, emergency flares, sand, a shovel, jumper cables, a window scraper, gloves, ground cloth, coveralls, a blanket, etc.

Snow tires

WARNING

Snow tires should be equivalent in size and type to the vehicle's standard tires. Otherwise, the safety and handling of your vehicle may be adversely affected.

Use snow tires when the road temperature is below 45 °F (7 °C). If you mount snow tires on your vehicle, be sure to use the same inflation pressure as the original tires. Mount snow tires on all four wheels to balance your vehicle's handling in all weather conditions. The traction provided by snow tires on dry roads may not be as high as your vehicle's original equipment tires. Check with the tire dealer for maximum speed recommendations.

Tire chains

Since the sidewalls of radial tires are thinner than other types of tires, they may be damaged by mounting some types of tire chains on them. Therefore, the use of snow tires is recommended

instead of tire chains. If tire chains must be used, use genuine HYUNDAI Parts and install the tire chains after reviewing the instructions provided with the tire chains. Damage to your vehicle caused by improper tire chain use is not covered by your vehicle manufacturer's warranty.

When using tire chains, attach them to the front wheels.

WARNING

The use of tire chains may adversely affect vehicle handling:

- Drive less than 20 mph (30 km/h) or the chain manufacturer's recommended speed limit, whichever is lower.
- Drive carefully and avoid bumps, holes, sharp turns, and other road hazards, which may cause the vehicle to bounce.
- Avoid sharp turns or locked wheel braking.
- Install tire chains only in pairs and on the front tires. Installing tire chains on the tires provides a greater driving force, but does not prevent side skids.

CAUTION

If your vehicle has 235/40R18 size tires, do not use tire chain; they can damage your vehicle (wheel, suspension and body).

Information

Do not install studded tires without first checking local and municipal regulations for possible restrictions against their use.

Chain installation

When installing tire chains, follow the manufacturer's instructions and mount them as tightly possible. Drive slowly (less than 20 mph (30 km/h) or the chain manufacturer's recommended speed limit) with chains installed. If you hear the chains contacting the body or chassis, stop and tighten them. If they still make contact, slow down until the noise stops. Remove the tire chains as soon as you begin driving on cleared roads.

When mounting snow chains, park the vehicle on level ground away from traffic. Turn on the vehicle's Hazard Warning Flasher and place a triangular emergency warning device behind the vehicle (if available). Always place the vehicle in P (Park), apply the parking brake, and turn off the engine before installing snow chains.

NOTICE

When using tire chains:

- Wrong size chains or improperly installed chains may damage your vehicle's brake lines, suspension, body, and wheels.
- Use SAE "S" class or wire chains.
- If you hear noise caused by chains contacting the body, retighten the chains to prevent contact with the vehicle body.
- To prevent body damage, retighten the chains after driving 0.3-0.6 mi. (0.5-1.0 km).
- Do not use tire chains on vehicles equipped with aluminum wheels. If unavoidable, use a wire type chain.
- Use wire chains less than 0.47 in. (12 mm) thick to prevent damage to the chain's connection.

Winter precautions

Use high quality ethylene glycol coolant

Your vehicle is delivered with high quality ethylene glycol coolant in the cooling system. It is the only type of coolant that should be used because it helps prevent corrosion in the cooling system, lubricates the water pump, and prevents freezing. Be sure to replace or replenish your coolant in accordance with the "Maintenance services" in chapter 9. Before winter, have your coolant tested to make sure that its freezing point is sufficient for the temperatures anticipated during the winter.

Check battery and cables

Winter temperatures may affect the battery performance. Inspect the battery and cables, as specified in chapter 9. The battery charging level can be checked by an authorized HYUNDAI dealer or in a service station.

Change to "winter weight" oil if necessary

In some regions in winter, it is recommended to use the "winter weight" oil with lower viscosity. In addition, replace the engine oil and filter if it is close to the next maintenance interval. Fresh engine oil ensures optimum engine operation during the winter months. For more information, refer to chapter 10. When you are not sure about a type of winter weight oil, contact an authorized HYUNDAI dealer.

Check spark plugs and ignition system

Inspect the spark plugs, as specified in chapter 9. If necessary, replace them. Also check all ignition wirings and components for any cracks, wear, and damage.

To prevent locks from freezing

Spray approved de-icing fluid or glycerin into key holes. When a lock opening is already covered with ice, spray approved de-icing fluid over the ice to remove it. When an internal part of a lock freezes, try to thaw it with a heated key. Carefully use the heated key to avoid an injury.

Use approved window washer anti-freeze solution

Add window washer anti-freeze solution, as specified on the window washer container. Window washer anti-freeze solution is available from an authorized HYUNDAI dealer, and most vehicle accessory outlets.

NOTICE

Do not use engine coolant or other types of anti-freeze solution, to prevent any damage to the vehicle paint.

Do not let your parking brake freeze

Under some conditions, your parking brake may freeze in the engaged position. This is most likely to happen when there is an accumulation of snow or ice around or near the rear brakes or the brakes are wet. When there is the risk that your parking brake may freeze: temporarily apply the parking brake with the gear in P (Park), then block the rear wheels, and then release the parking brake.

Do not let ice and snow accumulate underneath

Under some conditions, snow and ice may build up under the fenders and interfere with the steering. When driving in such conditions during the severe winter, check underneath the vehicle on a regular basis, to make sure that the front wheels and the steering components are not blocked.

Carry emergency equipment

In accordance with weather conditions, carry appropriate emergency equipment, while driving. Some of the items you may want to carry include tire chains, tow straps or chains, flashlight, emergency flares, sand, shovel, jumper cables, window scraper, gloves, ground cloth, coveralls, blanket, etc.

Do not place objects or materials in the engine compartment

Putting objects or materials in the engine compartment may cause an engine failure or a fire, because they may block the engine cooling. Such damage is not covered by the manufacturer's warranty.

To keep locks from freezing

To keep the locks from freezing, squirt an approved de-icer fluid or glycerine into the key opening. If a lock is covered with ice, squirt it with an approved deicing fluid to remove the ice. If the lock is frozen internally, you may be able to thaw it out by using a heated key. Handle the heated key with care to avoid injury.

Drive your vehicle when water vapor condenses and accumulates inside the exhaust pipes

When the vehicle is stopped for a long time in winter while the engine is running, water vapor may condense and accumulate inside the exhaust pipes. Water in the exhaust pipes may cause noise, etc., but it is drained driving at medium to high speed.

Trailer towing

Do not use this vehicle for trailer towing.

Vehicle load limit

Two labels on your driver's door sill show how much weight your vehicle was designed to carry: the Tire and Loading Information Label and the Certification Label.

Before loading your vehicle, familiarize yourself with the following terms for determining your vehicle's weight ratings, from the vehicle's specifications and the Certification Label:

Base Curb Weight

This is the weight of the vehicle including a full tank of fuel and all standard equipment. It does not include passengers, cargo, or optional equipment.

Vehicle Curb Weight

This is the weight of your new vehicle when you picked it up from your dealer plus any aftermarket equipment.

Cargo Weight

This figure includes all weight added to the Base Curb Weight, including cargo and optional equipment.

GAW (Gross Axle Weight)

This is the total weight placed on each axle (front and rear) - including vehicle curb weight and all payload.

GAWR (Gross Axle Weight Rating)

This is the maximum allowable weight that can be carried by a single axle (front or rear). These numbers are shown on the Certification Label. The total load on each axle must never exceed its GAWR.

GVW (Gross Vehicle Weight)

This is the Base Curb Weight plus actual Cargo Weight plus passengers.

GVWR (Gross Vehicle Weight Rating)

This is the maximum allowable weight of the fully loaded vehicle (including all options, equipment, passengers and cargo). The GVWR is shown on the Certification Label located on the driver's door sill.

Type C

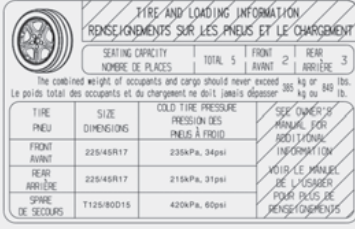

| TYRE AND LOADING INFORMATION RENSEIGNEMENTS SUR LES PNEUS ET LE CHARGEMENT | | | | |
|--|--------------------|--|---|-------------------|
| SEATING CAPACITY NOMBRE DE PLACES | | TOTAL 5 | FRONT AVANT 2 | REAR ARRIÈRE 3 |
| The combined weight of occupants and cargo should never exceed 385 kg or 849 lbs. Le poids total des occupants et du chargement ne doit jamais dépasser 385 kg ou 849 lb. | | | | |
| TYRE PNEU | SIZE DIMENSIONS | COLD TYRE PRESSURE PRESSION DES PNEUS À FROID | SEE OWNER'S MANUAL FOR ADDITIONAL INFORMATION VOIR LE MANUEL DE L'USAGER POUR PLUS DE RENSEIGNEMENTS | |
| FRONT AVANT | 225/45R17 | 238kPa, 34psi | | |
| REAR ARRIÈRE | 225/45R17 | 210kPa, 31psi | | |
| SPARE DE SECOURS | T125/80D15 | 420kPa, 60psi | | |

Type D

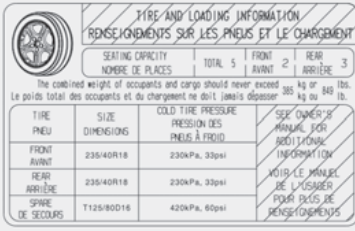

| TYRE AND LOADING INFORMATION RENSEIGNEMENTS SUR LES PNEUS ET LE CHARGEMENT | | | | |
|--|--------------------|--|---|-------------------|
| SEATING CAPACITY NOMBRE DE PLACES | | TOTAL 5 | FRONT AVANT 2 | REAR ARRIÈRE 3 |
| The combined weight of occupants and cargo should never exceed 385 kg or 849 lbs. Le poids total des occupants et du chargement ne doit jamais dépasser 385 kg ou 849 lb. | | | | |
| TYRE PNEU | SIZE DIMENSIONS | COLD TYRE PRESSURE PRESSION DES PNEUS À FROID | SEE OWNER'S MANUAL FOR ADDITIONAL INFORMATION VOIR LE MANUEL DE L'USAGER POUR PLUS DE RENSEIGNEMENTS | |
| FRONT AVANT | 235/40R18 | 230kPa, 33psi | | |
| REAR ARRIÈRE | 235/40R18 | 230kPa, 33psi | | |
| SPARE DE SECOURS | T125/80D15 | 420kPa, 60psi | | |

The loading information label

Type A

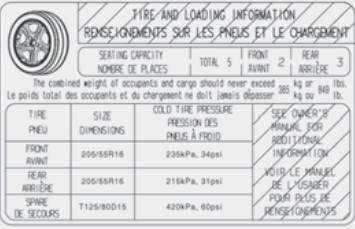

| TYRE AND LOADING INFORMATION RENSEIGNEMENTS SUR LES PNEUS ET LE CHARGEMENT | | | | |
|--|--------------------|--|---|-------------------|
| SEATING CAPACITY NOMBRE DE PLACES | | TOTAL 5 | FRONT AVANT 2 | REAR ARRIÈRE 3 |
| The combined weight of occupants and cargo should never exceed 385 kg or 849 lbs. Le poids total des occupants et du chargement ne doit jamais dépasser 385 kg ou 849 lb. | | | | |
| TYRE PNEU | SIZE DIMENSIONS | COLD TYRE PRESSURE PRESSION DES PNEUS À FROID | SEE OWNER'S MANUAL FOR ADDITIONAL INFORMATION VOIR LE MANUEL DE L'USAGER POUR PLUS DE RENSEIGNEMENTS | |
| FRONT AVANT | 205/55R16 | 238kPa, 34psi | | |
| REAR ARRIÈRE | 205/55R16 | 210kPa, 31psi | | |
| SPARE DE SECOURS | T125/80D15 | 420kPa, 60psi | | |

Type B

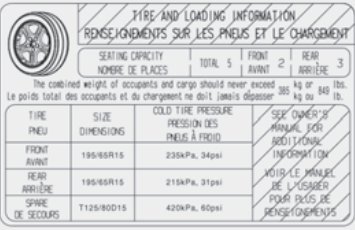

| TYRE AND LOADING INFORMATION RENSEIGNEMENTS SUR LES PNEUS ET LE CHARGEMENT | | | | |
|--|--------------------|--|---|-------------------|
| SEATING CAPACITY NOMBRE DE PLACES | | TOTAL 5 | FRONT AVANT 2 | REAR ARRIÈRE 3 |
| The combined weight of occupants and cargo should never exceed 385 kg or 849 lbs. Le poids total des occupants et du chargement ne doit jamais dépasser 385 kg ou 849 lb. | | | | |
| TYRE PNEU | SIZE DIMENSIONS | COLD TYRE PRESSURE PRESSION DES PNEUS À FROID | SEE OWNER'S MANUAL FOR ADDITIONAL INFORMATION VOIR LE MANUEL DE L'USAGER POUR PLUS DE RENSEIGNEMENTS | |
| FRONT AVANT | 195/65R15 | 238kPa, 34psi | | |
| REAR ARRIÈRE | 195/65R15 | 210kPa, 31psi | | |
| SPARE DE SECOURS | T125/80D15 | 420kPa, 60psi | | |

The label located on the driver's door jamb shows the original tire size, cold tire pressures recommended for your vehicle, the number of people that can be in your vehicle and vehicle capacity weight.

Occupants and cargo - Maximum Load

5 persons: 849 lbs (385 kg)

The combined weight of occupants and cargo should never exceed the maximum load limit shown on the Loading Information Label. Note that when towing a trailer, the combined weight must include the tongue load.

Seating capacity

Total: 5 persons (Front seat: 2 persons, Rear seat: 3 persons)

Seating capacity is the maximum number of occupants including a driver that your vehicle may carry. However, the seating capacity may be reduced based upon the weight of all of the occupants, and the weight of the cargo being carried or towed. Do not overload the vehicle because there is a limit to the total weight, or load limit including occupants and cargo that the vehicle can carry.

Towing capacity

Do not use this vehicle for trailer towing.

Cargo capacity







The cargo capacity of your vehicle increases or decreases depending on the weight, the number of occupants, and the tongue load, if your vehicle is equipped with a trailer.

Steps for determining correct load limit

1. Locate the statement "The combined weight of occupants and cargo should never exceed XXX kg or XXX lbs." on your vehicle's placard.
2. Determine the combined weight of the driver and passengers that will be riding in your vehicle.
3. Subtract the combined weight of the driver and passengers from XXX kg or XXX lbs.
4. The resulting figure equals the available amount of cargo and luggage load capacity. For example, if the "XXX" amount equals 1400 lbs. and there will be five 150 lb passengers in your vehicle, the amount of available cargo and luggage load capacity is 650 lbs. $(1400 - 750 (5 \times 150) = 650 \text{ lbs.})$
5. Determine the combined weight of luggage and cargo being loaded on the vehicle. That weight may not safely exceed the available cargo and luggage load capacity calculated in Step 4.
6. If your vehicle will be towing a trailer, load from your trailer will be transferred to your vehicle. Consult this manual to determine how this reduces the available cargo and luggage load capacity of your vehicle.

WARNING

Do not overload the vehicle because there is a limit to the total weight, or load limit, including occupants and cargo that the vehicle can carry. Overloading may shorten the life of the vehicle. If the GVWR or the GAWR is exceeded, parts on the vehicle may break, and it may change the handling of your vehicle. These may cause you to lose control and result in an accident.

| | | | | | |
|-------------------------|--|----------|---|----------|---|
| <p>Example 1</p> | <p>Vehicle Capacity</p> <p>Maximum Load (1400 lbs.) (635 kg)</p> | <p>≥</p> | <p></p> <p>Passenger Weight (150 lbs. × 2 = 300 lbs.) (68 kg × 2 = 136 kg)</p> | <p>+</p> | <p></p> <p>Cargo Weight (1100 lbs.) (499 kg)</p> |
| <p>Example 2</p> | <p>Vehicle Capacity</p> <p>Maximum Load (1400 lbs.) (635 kg)</p> | <p>≥</p> | <p></p> <p>Passenger Weight (150 lbs. × 5 = 750 lbs.) (68 kg × 5 = 340 kg)</p> | <p>+</p> | <p></p> <p>Cargo Weight (650 lbs.) (295 kg)</p> |
| <p>Example 3</p> | <p>Vehicle Capacity</p> <p>Maximum Load (1400 lbs.) (635 kg)</p> | <p>≥</p> | <p></p> <p>Passenger Weight (172 lbs. × 5 = 860 lbs.) (78 kg × 5 = 390 kg)</p> | <p>+</p> | <p></p> <p>Cargo Weight (540 lbs.) (245 kg)</p> |

Certification label



The certification label is located on the driver's door sill at the center pillar and shows the maximum allowable weight of the fully loaded vehicle. This is called the GVWR (Gross Vehicle Weight Rating). The GVWR includes the weight of the vehicle, all occupants, fuel, and cargo.

This label also tells you the maximum weight that can be supported by the front and rear axles, called Gross Axle Weight Rating (GAWR).

The total weight of the vehicle, including all occupants, accessories, cargo, and trailer tongue load must not exceed the Gross Vehicle Weight Rating (GVWR) or the Gross Axle Weight Rating (GAWR). To find out the actual loads on your front and rear axles, you need to go to a weigh station and weigh your vehicle. Be sure to spread out your load equally on both sides of the centerline.

WARNING

- Never exceed the GVWR for your vehicle, the GAWR for the front or rear axle and the vehicle capacity weight. Exceeding these ratings may affect your vehicle's handling and braking ability, and cause a collision.
- Do not overload your vehicle. Overloading your vehicle may cause heat buildup in your vehicle's tires, possible tire failure, increased stopping distances, and poor vehicle handling. All of which may result in a collision.

WARNING

If you carry items inside your vehicle (e.g., suitcases, tools, packages, or anything else), they are moving as fast as the vehicle. If you have to stop or turn quickly, or if there is a collision, the items may cause an injury if they strike the driver or a passenger.

- Put items in the cargo area of your vehicle. Try to spread the weight evenly.
- Do not stack items like suitcases inside the vehicle above the top of the seats.
- Do not leave an unsecured child restraint in your vehicle.
- When you carry cargo inside the vehicle, secure it.

7. Driver assistance system

| | |
|---|------|
| Before using driver assistance system..... | 7-4 |
| Driver assistance system settings | 7-5 |
| Forward Collision Avoidance Assist (FCA) (Front view camera only)..... | 7-6 |
| Forward Collision-Avoidance Assist settings..... | 7-6 |
| Forward Collision-Avoidance Assist operation..... | 7-7 |
| Forward Collision-Avoidance Assist malfunction and limitations..... | 7-9 |
| Forward Collision Avoidance Assist (FCA) (Sensor fusion)..... | 7-17 |
| Forward Collision-Avoidance Assist settings..... | 7-18 |
| Forward Collision-Avoidance Assist operation..... | 7-19 |
| Forward Collision-Avoidance Assist malfunction and limitations..... | 7-24 |
| Lane Keeping Assist (LKA)..... | 7-32 |
| Lane Keeping Assist settings..... | 7-32 |
| Lane Keeping Assist operation..... | 7-33 |
| Lane Keeping Assist malfunction and limitations | 7-35 |
| Blind-spot Collision-Avoidance Assist (BCA) | 7-37 |
| Blind-spot Collision-Avoidance Assist settings | 7-38 |
| Blind-spot Collision-Avoidance Assist operation | 7-39 |
| Blind-spot Collision-Avoidance Assist malfunction and limitations | 7-41 |
| Safe Exit Warning (SEW) | 7-45 |
| Safe Exit Warning settings | 7-45 |
| Safe Exit Warning operation..... | 7-46 |
| Safe Exit Warning malfunction and limitations | 7-47 |
| Manual Speed Limit Assist (MSLA)..... | 7-49 |
| Manual Speed Limit Assist operation | 7-49 |
| Intelligent Speed Limit Assist (ISLA) | 7-51 |
| Intelligent Speed Limit Assist settings | 7-52 |
| Intelligent Speed Limit Assist operation | 7-52 |
| Intelligent Speed Limit Assist malfunction and limitations | 7-54 |
| Driver Attention Warning (DAW) | 7-56 |
| Driver Attention Warning settings | 7-56 |
| Driver Attention Warning operation | 7-57 |
| Driver Attention Warning malfunction and limitations..... | 7-59 |
| Blind-spot View Monitor (BVM)..... | 7-62 |
| Blind-spot View Monitor settings | 7-62 |
| Blind-spot View Monitor operation | 7-62 |

| | |
|---|-------|
| Blind-spot View Monitor malfunction | 7-63 |
| Cruise Control (CC)..... | 7-63 |
| Cruise Control operation | 7-63 |
| Smart Cruise Control (SCC)..... | 7-67 |
| Smart Cruise Control settings | 7-67 |
| Smart Cruise Control operation | 7-68 |
| Smart Cruise Control malfunction and limitations | 7-76 |
| Navigation-based Smart Cruise Control (NSCC)..... | 7-82 |
| Navigation-based Smart Cruise Control settings | 7-82 |
| Navigation-based Smart Cruise Control operation | 7-83 |
| Limitations of Navigation-based Smart Cruise Control | 7-84 |
| Lane Following Assist (LFA)..... | 7-87 |
| Lane Following Assist operation | 7-87 |
| Lane Following Assist malfunction and limitations | 7-89 |
| Highway Driving Assist (HDA)..... | 7-90 |
| Highway Driving Assist settings | 7-90 |
| Highway Driving Assist operation | 7-91 |
| Highway Driving Assist malfunction and limitations | 7-93 |
| Rear View Monitor (RVM)..... | 7-94 |
| Rear View Monitor settings | 7-95 |
| Rear View Monitor operation | 7-95 |
| Rear View Monitor malfunction and limitations | 7-97 |
| Surround View Monitor (SVM) | 7-97 |
| Surround View Monitor settings | 7-98 |
| Surround View Monitor operation..... | 7-99 |
| Surround View Monitor malfunction and limitations | 7-101 |
| Rear Cross-traffic Collision-Avoidance Assist (RCCA) | 7-101 |
| Rear Cross-traffic Collision-Avoidance Assist settings | 7-102 |
| Rear Cross-traffic Collision-Avoidance Assist operation | 7-102 |
| Rear Cross-traffic Collision-Avoidance Assist malfunction and limitations | 7-106 |
| Forward/Reverse Parking Distance Warning (PDW) | 7-110 |
| Forward/Reverse Parking Distance Warning operation | 7-110 |
| Forward/Reverse Parking Distance Warning malfunction and precautions | 7-112 |
| Reverse Parking Collision-Avoidance Assist (PCA) | 7-114 |
| Reverse Parking Collision-Avoidance Assist settings | 7-114 |

7. Driver assistance system

| | |
|--|-------|
| Reverse Parking Collision-Avoidance Assist operation..... | 7-115 |
| Reverse Parking Collision-Avoidance Assist malfunction and limitations | 7-116 |
| Driver assistance system sensors..... | 7-120 |
| Cameras..... | 7-120 |
| Radars | 7-121 |
| Ultrasonic sensors..... | 7-122 |
| Declaration of conformity..... | 7-123 |
| Front radar..... | 7-123 |
| Rear corner radar | 7-124 |

Before using driver assistance system

WARNING

Always maintain a safe distance from the vehicles ahead and adjust your vehicle speed to the road conditions. Driver Assistance system may not operate in all situations and cannot avoid all collisions.

To prevent serious injury or death:

- Control your vehicle at all times. In some cases, the Driver Assistance system may provide unanticipated braking or steering.
 - Never attempt to activate any Driver Assistance system by intentionally driving toward people, animals, objects, or other vehicles.
 - The steering, braking, and acceleration inputs from you may override the responses from driver assistance system.
 - Do not use Driver Assistance system when towing a trailer or using a hitch mounted carrier.
 - Do not use Driver Assistance system if you believe the sensors or the systems may not be functioning properly.
-

Information

Due to the infotainment software version, the description of each function of the driver assistance system may differ from the owner's manual.

Limitations of driver assistance system

Nearby vehicles, road conditions, or other factors may delay the response from Driver Assistance system or cause these systems not to function, including:

- Lane-restricted driving situations (tollbooths, construction zones, etc.)
- Curves, hills, or other road features that may detect vehicles in adjacent lanes or not detect vehicles ahead in the roadway
- If other vehicles, pedestrians, or cyclists are not detected
- Driving in inclement weather, such as heavy rain, snow or icy conditions
- Interference from strong electromagnetic waves
- Streets with railroad tracks or other embedded metal objects
- If anything is blocking or covering a sensor
- If any camera, radar, or sensor is damaged

Driver assistance system settings

Warning Methods

Type A

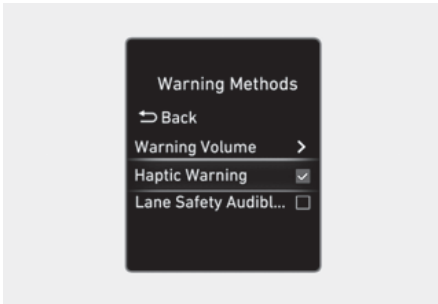

Type B

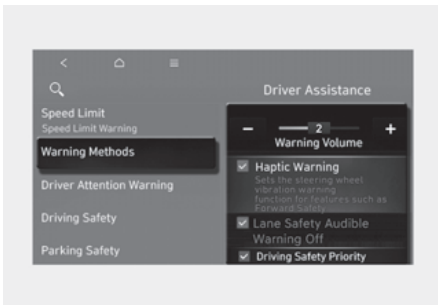

The Warning Methods can be set with the vehicle on. Select **User Settings > Driver Assistance > Warning Methods** from the settings menu in the instrument cluster or Press **Settings** and select **Vehicle > Driver Assistance > Warning Methods** from the infotainment system to change the following settings:

- **Warning Volume:** Adjusts the volume of the warning sound.
- **Haptic Warning:** Activate the steering wheel vibration warning. (if equipped)
- **Lane Safety Audible Warning Off:** Turns off the Lane Safety Audible Warning, even when both warning volume and haptic warning are on.

- **Driving Safety Priority:** Lowers all other audio volumes when the Driving Safety system sounds a warning.
- **Parking Safety Priority:** Lowers all other audio volumes when the Parking Assist view is active.

⚠ CAUTION

For safety, the warning method is different depending on each function of the driver assistance system.

Please check how each function warns you.

i Information

- If you change the Warning Methods, it can be applied to each function of the driver assistance system. Please check and change it in each function.
- If the vehicle is restarted, Warning Methods will maintain the last setting.
- The setting menu may not exist based on vehicle specification.
- If you turn off the **Warning Volume**, for your safety, the function may warn you with a low volume, except Blind-Spot Collision-Avoidance Assist and Rear Cross-Traffic Collision-Avoidance Assist.
- The **Warning Volume** and **Haptic Warning** cannot be turned off at the same time. When one of the warning is turned off the other is activated.
- The **Lane Safety Audible Warning Off** can be set when both the Warning Volume and the Haptic Warning are on.

Forward Collision Avoidance Assist (FCA) (Front view camera only)

 If equipped

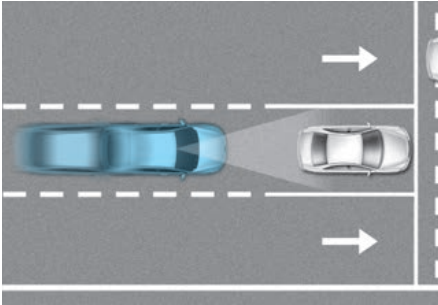

Forward Collision-Avoidance Assist uses the front view camera to help detect a vehicle, a pedestrian ahead on the road. The function may warn you with a warning message on the instrument cluster and an audible warning if a collision is imminent. If necessary, it may assist with braking your vehicle to help reduce collision speed and avoid a collision.

Information

Forward Collision-Avoidance Assist (Front view camera only) uses the following sensor:

- Front view camera

Refer to the "Driver assistance system sensors" section in this chapter for the location.

Forward Collision-Avoidance Assist settings

Forward Safety

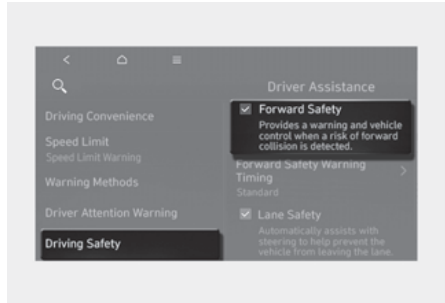

With the ignition switch ON, go to **User Settings > Driver Assistance > Driving Safety** from the settings menu in the instrument cluster or **Settings > Vehicle > Driver Assistance > Driving Safety** from the settings menu in the infotainment system to select the following:

- If **Forward Safety** is selected, Forward Collision-Avoidance Assist will warn the driver with a warning message, an audible warning depending on the collision risk levels. Braking assist will be applied depending on the collision risk levels. If Forward Safety is deselected, Forward Safety will turn off. The warning light () will illuminate on the cluster.

WARNING

Each time the engine is restarted, Forward Collision-Avoidance Assist turns on.

If **Forward Safety** is selected after the engine is restarted, the function does NOT brake your vehicle to help avoid a collision.

Forward Safety Warning Timing

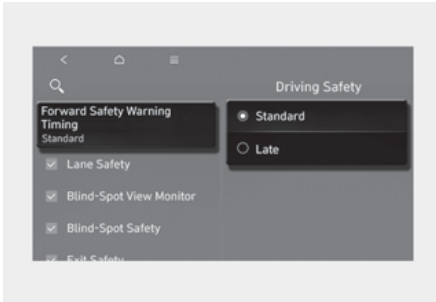

With the ignition switch ON, go to **User Settings > Driver Assistance > Driving Safety > Forward Safety Warning Timing** from the settings menu in the instrument cluster or **Settings > Vehicle > Driver Assistance > Driving Safety > Forward Safety Warning Timing** settings menu in the infotainment system to change the initial warning activation time. Warning Timing is set to **Standard** at the factory.

WARNING

- Even though Standard is selected for Forward Safety Warning Timing if the vehicle ahead of you suddenly stops, the initial warning activation time may not seem late.
- Select Late for Forward Safety Warning Timing when traffic is light and your vehicle speed is slow.

Information

When the engine is restarted, the Warning Timing maintains its last setting.

Information

You can set the following Warning Methods:

- Warning Volume/Haptic Warning/Driving Safety Priority

For more information, refer to the "Driver assistance system settings" section in this chapter.

Forward Collision-Avoidance Assist operation

Forward Collision-Avoidance Assist may warn and brake your vehicle depending on the collision risk level.

Basic function

Collision Warning



If Forward Collision-Avoidance Assist judges that a collision may occur, the message may appear on the instrument cluster and an audible warning is heard when:

- A vehicle or powered two-wheeler is detected, and your vehicle speed is about 6-112 mph (10-180 km/h).
- A pedestrian or cyclist is detected, and your vehicle speed is about 6-50 mph (10-80 km/h).

Emergency Braking

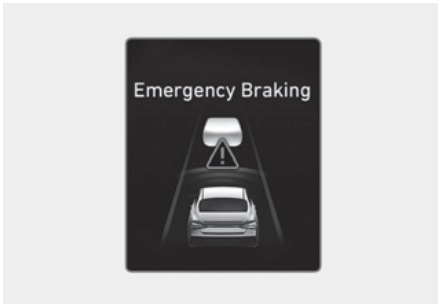

If Forward Collision-Avoidance Assist judges avoiding a collision may be difficult, it applies higher brake force that may help avoid a collision with the vehicle, pedestrian or cyclist detected ahead.

The warning message may appear on the instrument cluster and an audible warning is heard when:

- A vehicle or powered two-wheeler is detected, and your vehicle speed is about 6-37 mph (10-60 km/h).
- A pedestrian or cyclist is detected, and your vehicle speed is about 6-37 mph (10-60 km/h).

Stopping vehicle and ending brake control

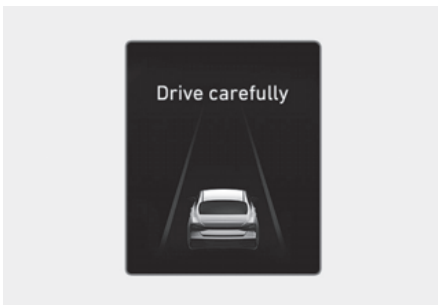

After your vehicle has stopped following an Emergency Braking event, the "Drive carefully" warning message may appear on the instrument cluster.

Depress the brake pedal immediately and check the surroundings.

- Braking control ends about 2 seconds after your vehicle is stopped following an Emergency Braking event.

WARNING

Forward Collision-Avoidance Assist may not operate in all situations and cannot avoid all collisions.

To prevent serious injury or death:

- Only change the settings after parking your vehicle at a safe location.
- Control your vehicle at all times. Do not depend on Forward Collision-Avoidance Assist to avoid a collision. Always maintain a safe distance from the vehicles ahead and reduce your vehicle speed as needed.
- Forward Collision-Avoidance Assist may stop operating, or may not operate, or operate unnecessarily depending on the road conditions and surroundings.
- When Active Assist or Warning Only is selected and ESC is turned off by pressing and holding the ESC OFF button, Forward Collision-Avoidance Assist turns off automatically. Then the Forward Collision-Avoidance Assist settings cannot be changed using the settings menu and the  warning light illuminates on the instrument cluster. If ESC is turned on again by pressing the ESC OFF button, Forward Collision-Avoidance Assist maintains its last setting.
- Never attempt to activate Forward Collision-Avoidance Assist by intentionally driving toward people, animals, objects, or other vehicles.
- Forward Collision-Avoidance Assist may not assist braking your vehicle if you depress the brake pedal sufficiently in response to the potential hazard detected by the function to avoid all collisions.

- During Forward Collision-Avoidance Assist operation, your vehicle may stop suddenly. Always wear your seat belt, check your passengers have their seat belts fastened and secure loose objects that may become projectiles.
- When other system's warning message appears or audible warning is heard, Forward Collision-Avoidance Assist may not warn you.
- You may not hear the audible warning of Forward Collision-Avoidance Assist if the surrounding environment is too noisy.

WARNING

- Even if there is an issue with Forward Collision-Avoidance Assist, the vehicle's braking system operates normally.
- During emergency braking, braking by the Forward Collision-Avoidance Assist automatically cancels if you depress the accelerator pedal or sharply steer your vehicle.
- Depending on the characteristics of the vehicle, pedestrian detected, and the surroundings, the speed or detection ranges for Forward Collision-Avoidance Assist may be reduced. The function may not operate or be limited.
- Forward Collision-Avoidance Assist operates only under certain conditions that determines the risk level:
 - Condition of other vehicles
 - The direction vehicles are driven
 - Vehicle speed
 - Surroundings
- If your vehicle speed is too high or the speed difference from the other vehicle is too large, the function may be limited or not operate.



i Information

- When a collision is imminent, braking may be assisted if you depress the brake pedal insufficiently.
- The images and colors in the instrument cluster may differ depending on the cluster type or theme selected from the settings menu.

Forward Collision-Avoidance Assist malfunction and limitations

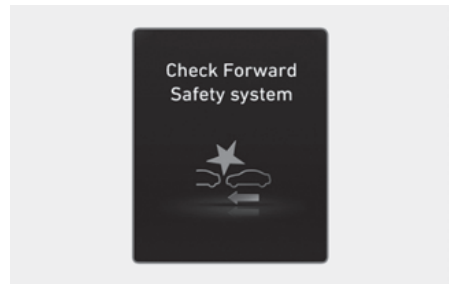
Forward Collision-Avoidance Assist malfunction



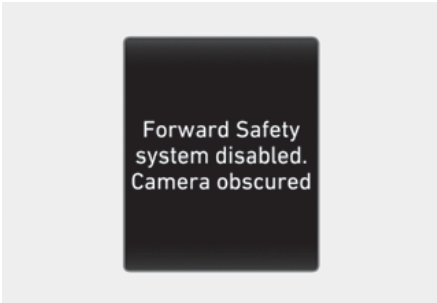

When Forward Collision-Avoidance Assist is not working properly, the "**Check Forward Safety system**" warning message may appear, and the  and  warning lights may illuminate on the instrument cluster. Have the vehicle inspected by an authorized HYUNDAI dealer.

Forward Collision-Avoidance Assist disabled



When the front view camera is covered or blocked, Forward Collision-Avoidance Assist may be temporarily limited or disabled.

The "**Forward Safety system disabled. Camera obscured**" warning message may appear, and the  and  warning lights may illuminate on the instrument cluster.

The function operates normally when such foreign material is removed, and the engine is restarted.

If Forward Collision-Avoidance Assist does not operate normally after the sensor has been uncovered or unblocked, have the vehicle inspected by an authorized HYUNDAI dealer.

WARNING

- Forward Collision-Avoidance Assist may not operate properly even if there is no warning message or warning light on the instrument cluster.
- Forward Collision-Avoidance Assist may not operate properly in open areas where no objects are detected (e.g. empty parking lot) or when the detecting sensors are blocked right after turning on the engine.
- Forward Collision-Avoidance Assist may not operate properly even after the engine has been restarted when the detecting sensors are blocked or there is a problem with the function.

Limitations of Forward Collision-Avoidance Assist

Forward Collision-Avoidance Assist may not operate normally or may operate unexpectedly if:

- The detecting sensor or the surroundings are contaminated or damaged.
- The temperature around the front view camera is high or low due to surrounding environment.
- The camera lens is contaminated due to tinted, filmed or coated windshield, damaged glass, or sticky foreign material (sticker, bug, etc.) on the glass.
- Moisture is not removed or frozen on the windshield.
- Washer fluid is continuously sprayed, or the wiper is on.
- Driving in heavy rain or snow, or thick fog.
- The field of view of the front view camera is obstructed by sun glare.
- Street light or light from an oncoming traffic is reflected on the wet road surface, such as a puddle on the road.
- An object is placed on the dashboard.

- Your vehicle is being towed.
- The surrounding is very bright.
- The surrounding is very dark, such as in a tunnel, etc.
- The brightness changes suddenly, for example when entering or exiting a tunnel.
- The brightness outside is low, and the headlights are not on or are not bright.
- Driving through steam, smoke or shadow.
- Only part of the vehicle, powered two-wheeler, pedestrian or cyclist is detected.
- The vehicle in front is a bus, heavy truck, truck with an unusually shaped cargo, trailer, etc.
- The vehicle or powered two-wheeler in front has no tail lights, tail lights are located unusually, etc.
- The brightness outside is low, and the tail lights are not on or are not bright.
- The rear of the front vehicle is small or the vehicle does not look normal, such as when the vehicle is tilted, overturned, or the side of the vehicle is visible, etc.
- The front vehicle's ground clearance is low or high.
- A vehicle, powered two-wheeler, pedestrian or cyclist suddenly cuts in front.
- The vehicle or powered two-wheeler in front is detected late.
- The vehicle or powered two-wheeler in front is suddenly blocked by an obstacle.
- The vehicle or powered two-wheeler in front suddenly changes lane or suddenly reduces speed.
- The vehicle or powered two-wheeler in front is bent out of shape.
- The front vehicle's speed is fast or slow.
- The vehicle or powered two-wheeler in front steers in the opposite direction of your vehicle to avoid a collision.
- With a vehicle in front, your vehicle changes lane at low speed.
- The vehicle in front is covered with snow.
- You are departing or returning to the lane.
- Unstable driving.
- You are on a roundabout and the vehicle in front is not detected.
- You are continuously driving in a circle.
- The vehicle or powered two-wheeler in front has an unusual shape.
- The vehicle or powered two-wheeler in front is driving uphill or downhill.
- The pedestrian or cyclist is not fully detected, for example, if the pedestrian is leaning over or is not fully walking upright.
- The pedestrian or cyclist is wearing clothing or equipment that makes it difficult to detect as a pedestrian or cyclist.



The illustration above shows the image the front view camera is capable of detecting as a vehicle, powered two-wheeler, pedestrian and cyclist.

- The pedestrian or cyclist in front is moving very quickly.
- The pedestrian or cyclist in front is short or is posing a low posture.

- The pedestrian or cyclist in front has impaired mobility.
- The pedestrian or cyclist in front is moving intersected with the driving direction.
- There is a group of pedestrians, cyclists or a large crowd in front.
- The pedestrian or cyclist is wearing clothing that easily blends into the background, making it difficult to detect.
- The pedestrian or cyclist is difficult to distinguish from the similarly shaped structure in the surroundings.
- You are driving by a pedestrian, cyclist, traffic signs, structures, etc., near the intersection.
- Driving in a parking lot.
- Driving through a tollgate, construction area, unpaved road, partial paved road, uneven road, speed bumps, etc.
- Driving on an incline road, curved road, etc.
- Driving through a roadside with trees or streetlights.
- The adverse road conditions cause excessive vehicle vibrations while driving.
- Your vehicle height is low or high due to heavy loads, abnormal tire pressure, etc.
- Driving through a narrow road where trees or grass or overgrown.
- There is interference by electromagnetic waves, such as driving in an area with strong radio waves or electrical noise.

WARNING

• Driving on a curved road

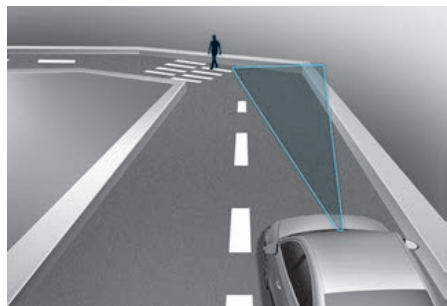
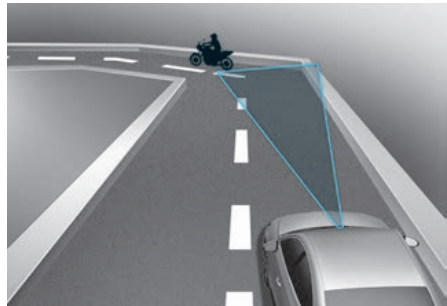
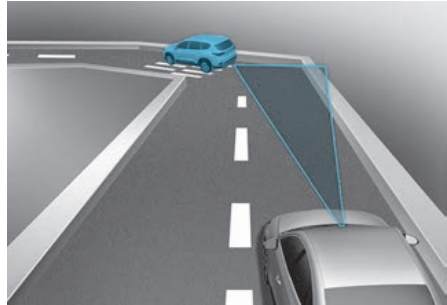

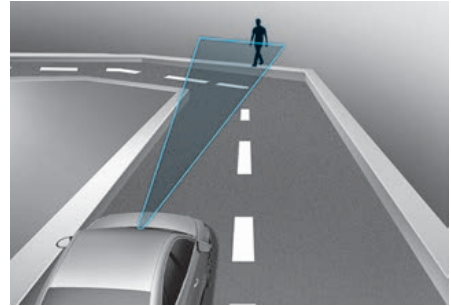
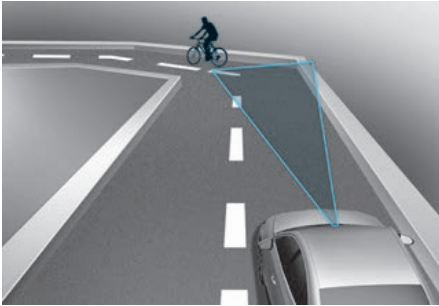

Forward Collision-Avoidance Assist may not detect other vehicles, powered two-wheeler, pedestrians or cyclists in front of you when driving on a curve and may not activate a warning or brake your vehicle when needed.

When driving on a curved road, always maintain a safe distance from others on the road. Reduce your vehicle speed or steer your vehicle as needed.

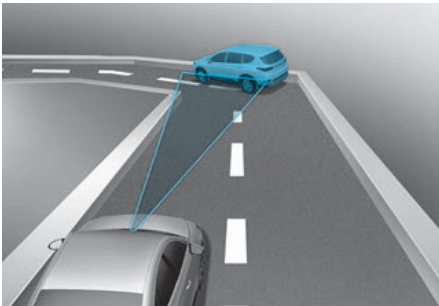
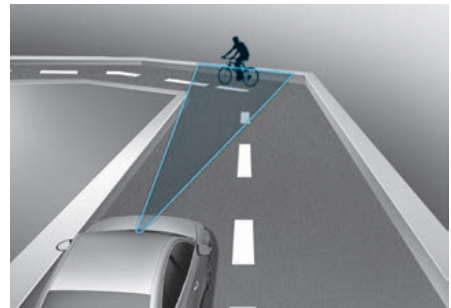

If a vehicle, powered two-wheeler, pedestrian or cyclist is detected in the next lane or outside the lane when driving on a curved road, Forward Collision-Avoidance Assist may warn you and may brake your vehicle even when not needed.

Always check road conditions, and if necessary, take appropriate actions to drive safely.

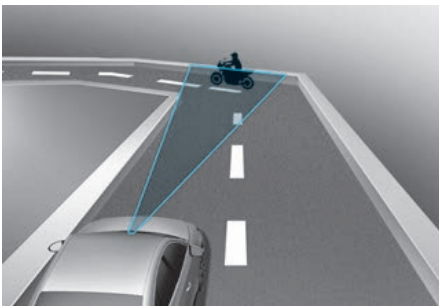

• Driving on an inclined road

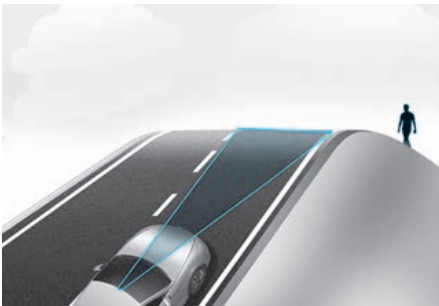
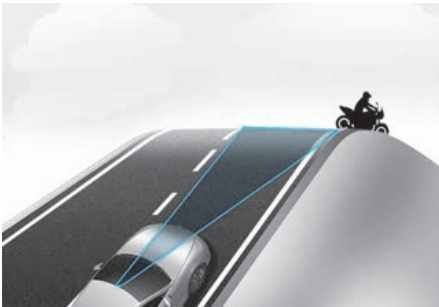
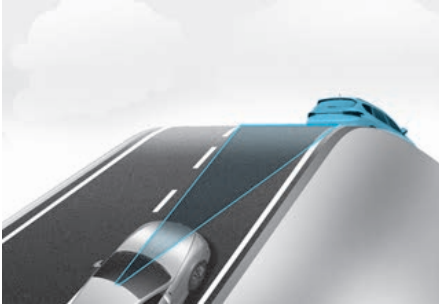

Forward Collision-Avoidance Assist may not detect other vehicles, powered two-wheeler, pedestrians or cyclists in front of you while driving uphill or downhill.

This may result in unnecessary warning or braking assist, or no warning or braking assist when needed.

Also, vehicle speed may rapidly decrease when a vehicle, powered two-wheeler, pedestrian or cyclist ahead is suddenly detected. Always maintain a safe distance from the others on the road. Adjust your vehicle speed or steer your vehicle depending on the road conditions.

• Changing lanes

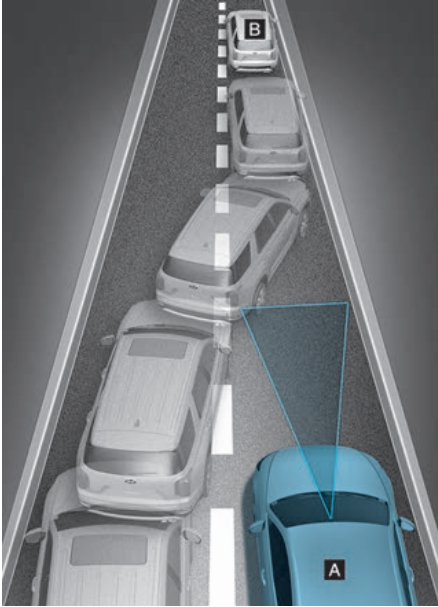

- [A] Your vehicle
- [B] Lane changing vehicle

When a vehicle moves into your lane from an adjacent lane, it cannot be detected by the sensor until it is in the sensor's detection range. Forward Collision-Avoidance Assist may not immediately detect the vehicle or powered two-wheeler when the vehicle changes lanes abruptly.

In this case, you must maintain a safe braking distance, and if necessary, steer your vehicle and depress the brake pedal to reduce your driving speed in order to maintain a safe distance.

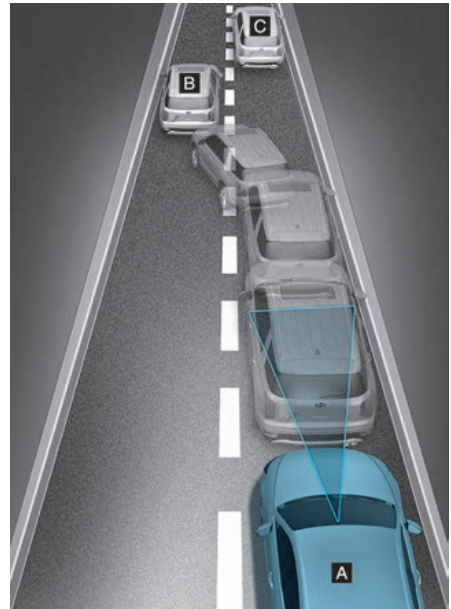

- [A] Your vehicle
- [B] Lane changing vehicle
- [C] Same lane vehicle

When a vehicle or powered two-wheeler in front of you merges out of the lane, Forward Collision-Avoidance Assist may not immediately detect the vehicle that is now in front of you.

In this case, you must maintain a safe braking distance, and if necessary, steer your vehicle and depress the brake pedal to reduce your driving speed in order to maintain a safe distance.

• **Detecting a vehicle**

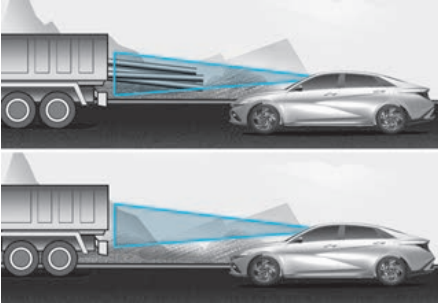

Forward Collision-Avoidance Assist may not be able to detect all potential hazards, like if the vehicle in front of you has cargo that extends rearward past the end of the vehicle or if the vehicle in front of you has higher ground clearance. Always maintain a safe distance from the vehicles ahead. Adjust your vehicle speed or steer your vehicle depending on the road conditions.

! WARNING

- When you are towing a trailer or another vehicle, turn off Forward Collision-Avoidance Assist.
- Forward Collision-Avoidance Assist may operate if objects that are similar in shape or characteristics to vehicles, powered two-wheelers, pedestrians are detected.
- Forward Collision-Avoidance Assist may not detect bicycles, motorcycles, or smaller wheeled objects such as luggage bags, shopping carts, or strollers.
- Forward Collision-Avoidance Assist may not operate normally if there is interference from strong electromagnetic waves.
- Forward Collision-Avoidance Assist may not operate for 15 seconds right after your vehicle is started or when the front view camera is initialized.

Forward Collision Avoidance Assist (FCA) (Sensor fusion)

 if equipped

Basic function

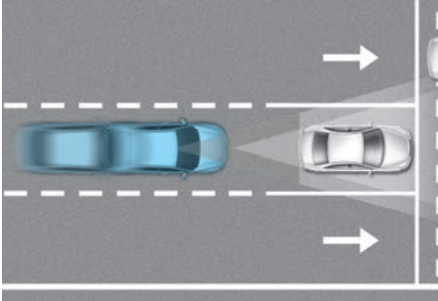

Forward Collision-Avoidance Assist detects a vehicle, a powered two-wheeler, a pedestrian, or a cyclist ahead on the road and may warn you of a possible collision with a warning message on the instrument cluster and a warning sound. Also, Forward Collision-Avoidance Assist may assist with braking your vehicle to help reduce collision speed or avoid a collision.

Junction Turning function

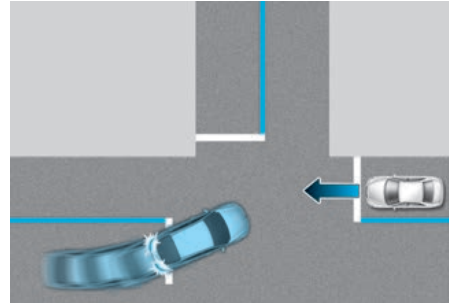

Junction Turning function can help avoid a collision with an oncoming vehicle in an adjacent lane when turning left at a crossroad with the turn signal on by applying emergency braking.

Direct Oncoming function

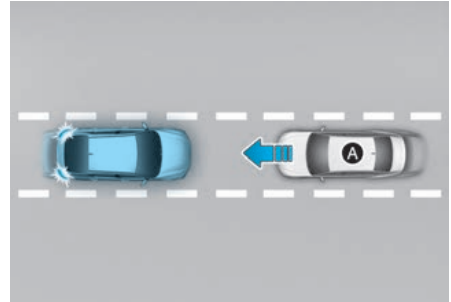

[A] Oncoming vehicle

Direct Oncoming function helps reduce the speed at the collision when a vehicle approaching from the opposite side is detected.

i Information

Forward Collision-Avoidance Assist (Sensor fusion) uses the following sensors:

- Front view camera
- Front radar

Refer to the "Driver assistance system sensors" section in this chapter for the location.

Forward Collision-Avoidance Assist settings

Forward Safety

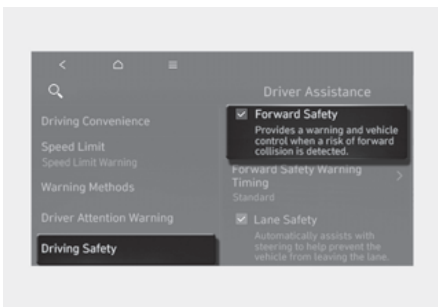

With the ignition switch ON, go to **User Settings > Driver Assistance > Driving Safety** from the Settings menu in the instrument cluster or **Settings > Vehicle > Driver Assistance > Driving Safety** from the settings menu in the infotainment system to select the following:

- If **Forward Safety** is selected, Forward Collision-Avoidance Assist will warn the driver with a warning message, an audible warning depending on the collision risk levels. Braking assist will be applied depending on the collision risk levels.

If **Forward Safety** is deselected, Forward Safety will turn off. The warning light (🚦) will illuminate on the instrument cluster.

! WARNING

When the engine is restarted, Forward Collision-Avoidance Assist will always turn on.

However, if **Forward Safety** is deselected, the driver should always be aware of the surroundings and drive safely.

! CAUTION

The setting for Forward Safety includes 'Basic function' and 'Junction Turning'.

Forward Safety Warning Timing

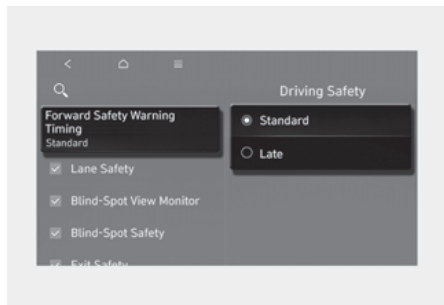

With the ignition switch ON, go to **User Settings > Driver Assistance > Driving Safety > Forward Safety Warning Timing** from the settings menu in the instrument cluster or **Settings > Vehicle > Driver Assistance > Driving Safety > Forward Safety Warning Timing** settings menu in the infotainment system to change the initial warning activation time. Warning Timing is set to **Standard** at the factory.

WARNING

- Even though Standard is selected for Forward Safety Warning Timing if the vehicle ahead of you suddenly stops, the initial warning activation time may not seem late.
- Select Late for Forward Safety Warning Timing when traffic is light and your vehicle speed is slow.

Information

When the engine is restarted, the Warning Timing maintains its last setting.

Information

You can set the following Warning Methods:

- Warning Volume/Haptic
Warning/Driving Safety Priority

For more information, refer to the "Driver assistance system settings" section in this chapter.

Forward Collision-Avoidance Assist operation

Basic function

Forward Collision-Avoidance Assist may warn and brake your vehicle depending on the collision risk level.

Collision Warning



If Forward Collision-Avoidance Assist judges that a collision may occur, the message may appear on the instrument cluster and an audible warning is heard when:

- A vehicle or powered two-wheeler is detected, and your vehicle speed is about 6-125 mph (10-200 km/h).
- A pedestrian or cyclist is detected, and your vehicle speed is about 6-53 mph (10-85 km/h).

Emergency Braking

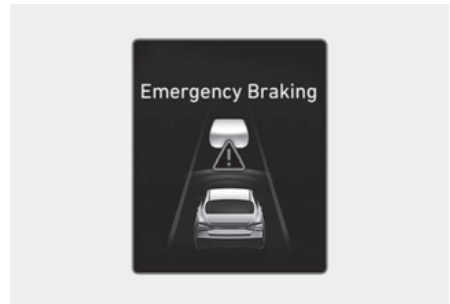

If Forward Collision-Avoidance Assist judges avoiding a collision may be difficult, it applies higher brake force that may help avoid a collision with the vehicle, pedestrian, or cyclist detected ahead.

The warning message may appear on the instrument cluster and an audible warning is heard when:

- Vehicle or powered two-wheeler:

| | Driving vehicle | Stopped vehicle |
|----------------------|---------------------------------------|-------------------------------------|
| Weak braking power | Approximately 6-125 mph (10-200 km/h) | |
| Strong braking power | Approximately 6-81 mph (10-130 km/h) | Approximately 6-47 mph (10-75 km/h) |

- Pedestrian or cyclist:
The function will operate when your vehicle speed is between approximately 6-40 mph (10-65 km/h).

Stopping vehicle and ending brake control

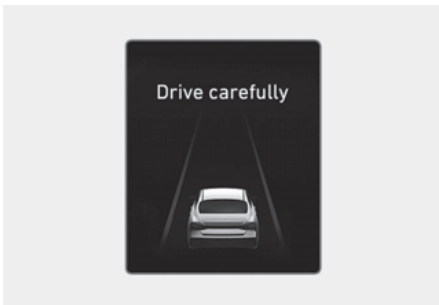

After your vehicle has stopped following an Emergency Braking event, the "**Drive carefully**" warning message may appear on the instrument cluster.

Depress the brake pedal immediately and check the surroundings.

- Braking control ends about 2 seconds after your vehicle is stopped following an Emergency Braking event.

Junction Turning function

Junction Turning function will warn and help control the vehicle depending on the collision risk level: 'Collision Warning', 'Emergency Braking' and 'Stopping vehicle and ending brake control'.

Collision Warning



If Forward Collision-Avoidance Assist judges that a collision may occur, the message may appear on the instrument cluster and an audible warning is heard when:

- Your vehicle speed is about 6-19 mph (10-30 km/h) and the oncoming vehicle speed is about 19-44 mph (30-70 km/h).

Emergency Braking

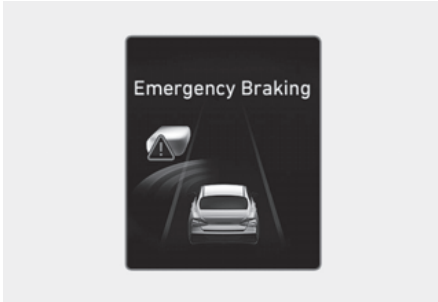

If Forward Collision-Avoidance Assist judges avoiding a collision may be difficult, it applies higher brake force that may help avoid a collision with the oncoming vehicle detected.

The warning message may appear on the instrument cluster and an audible warning is heard when:

- Your vehicle speed is about 6-19 mph (10-30 km/h) and the oncoming vehicle speed is about 19-44 mph (30-70 km/h).

Stopping vehicle and ending brake control



- After your vehicle has stopped following an Emergency Braking event, the "**Drive carefully**" warning message may appear on the instrument cluster. Depress the brake pedal immediately and check the surroundings.
- Braking control ends about 2 seconds after your vehicle is stopped following an Emergency Braking event.

Direct Oncoming function

Direct Oncoming function will warn and control the vehicle depending on the collision risk level: 'Collision Warning', 'Emergency Braking' and 'Stopping vehicle and ending brake control'.

Collision Warning

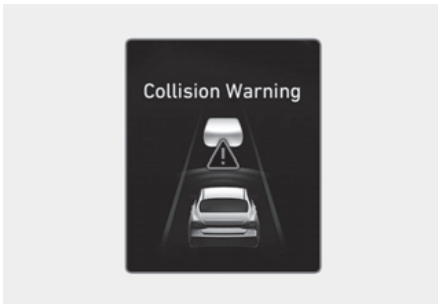

- To warn the driver of a collision, Forward Safety warning light (🚦) blinking, the "**Collision Warning**" warning message will appear on the instrument cluster, an audible warning will sound.
- The function will operate when your vehicle speed is between about 19-80 mph (30-130 km/h) and the detected oncoming vehicle speed is about above 6 mph (10 km/h) and the oncoming vehicle speed is about above 6 mph (10 km/h).

Emergency Braking

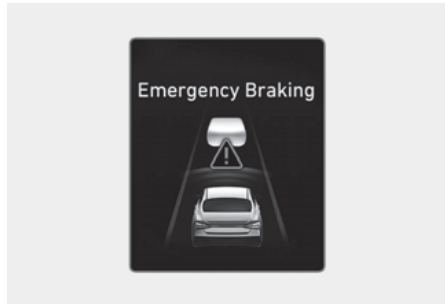

- To warn the driver that emergency braking will be assisted, Forward Safety warning light (🚦) blinking, the "**Emergency Braking**" warning message will appear on the instrument cluster, an audible warning will sound.
- In emergency braking situation, braking is assisted with strong braking power by the function to help prevent collision with the oncoming vehicle.
- The function will operate when your vehicle speed is between about 19-80 mph (30-130 km/h) and the detected oncoming vehicle speed is about above 6 mph (10 km/h).

Stopping vehicle and ending brake control



- When the vehicle is stopped due to emergency braking, the "**Drive carefully**" warning message will appear on the instrument cluster. For your safety, the driver should depress the brake pedal immediately and check the surroundings.
- Brake control will end after the vehicle is stopped by emergency braking for about 2 seconds.

CAUTION

If your vehicle or the oncoming vehicle is not driving straight, Direct Oncoming function warning and control may be late or may not operate.

Information

Press the hazard warning flasher to turn off the audible warning of the collision warning or emergency braking system.

WARNING

Forward Collision-Avoidance Assist may not operate in all situations and cannot avoid all collisions.

To prevent serious injury or death:

- Only change the settings after parking your vehicle at a safe location.
- Control your vehicle at all times. Do not depend on Forward Collision-Avoidance Assist to avoid a collision. Always maintain a safe distance from the vehicles ahead and reduce your vehicle speed as needed.
- Forward Collision-Avoidance Assist may stop operating, or may not operate, or operate unnecessarily depending on the road conditions and surroundings.
- When Active Assist or Warning Only is selected and ESC is turned off by pressing and holding the ESC OFF button, Forward Collision-Avoidance Assist turns off automatically. Then the Forward Collision-Avoidance Assist settings menu and the  warning light illuminates on the instrument cluster. If ESC is turned on again by pressing the ESC OFF button, Forward Collision-Avoidance Assist maintains its last setting.
- Never attempt to activate Forward Collision-Avoidance Assist by intentionally driving toward people, animals, objects, or other vehicles.
- Forward Collision-Avoidance Assist may not assist braking your vehicle if you depress the brake pedal sufficiently in response to the potential hazard detected by the function to avoid all collisions.

- During Forward Collision-Avoidance Assist operation, your vehicle may stop suddenly. Always wear your seat belt, check your passengers have their seat belts fastened and secure loose objects that may become projectiles.
- When other system's warning message appears or audible warning is heard, Forward Collision-Avoidance Assist may not warn you.
- You may not hear the audible warning of Forward Collision-Avoidance Assist if the surrounding environment is too noisy.
- Even if there is a problem with Forward Collision-Avoidance Assist, the vehicle's basic braking will function normally.
- During emergency braking, braking control by Forward Collision-Avoidance Assist will automatically cancel when the driver excessively depresses the accelerator pedal or sharply steers the vehicle.

CAUTION

- Depending on the condition of the vehicle, powered two-wheeler, pedestrian and cyclist in front and the surroundings, the speed range to operate Forward Collision-Avoidance Assist may reduce. Forward Collision-Avoidance Assist may only warn the driver, or it may not operate.
- Forward Collision-Avoidance Assist will operate under certain conditions by judging the risk level based on the condition of the oncoming vehicle, powered two-wheeler, driving direction, speed and surroundings.
- Forward Collision-Avoidance Assist may be limited or disabled if the vehicle or powered two-wheeler speed is too high or the distance to the vehicle ahead is far.

Information

- In a situation collision is imminent, braking may be assisted by Forward Collision-Avoidance Assist when braking is insufficient by the driver.
- The images and colors in the instrument cluster may differ depending on the cluster type or theme selected from the instrument cluster.

Forward Collision-Avoidance Assist malfunction and limitations

Forward Collision-Avoidance Assist malfunction

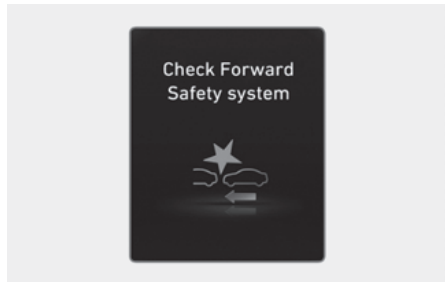

When Forward Collision-Avoidance Assist is not working properly, the "**Check Forward Safety system**" warning message may appear, and the  and warning lights may illuminate on the instrument cluster. Have the vehicle inspected by an authorized HYUNDAI dealer.

Forward Collision-Avoidance Assist disabled

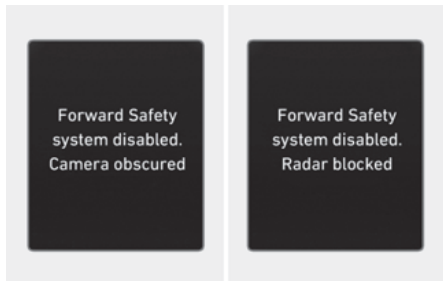

When the front view camera or front radar is covered or blocked, Forward Collision-Avoidance Assist may be temporarily limited or disabled.

The "**Forward Safety system disabled. Camera obscured**" and "**Forward Safety system disabled. Radar blocked**" warning messages may appear, and the

⚠ and 🚫 warning lights may illuminate on the instrument cluster.

The function operates normally when such foreign material is removed, and the engine is restarted.

If Forward Collision-Avoidance Assist does not operate normally after the sensor has been uncovered or unblocked, have the vehicle inspected by an authorized HYUNDAI dealer.

⚠ WARNING

- Forward Collision-Avoidance Assist may not operate properly even if there is no warning message or warning light on the instrument cluster.
- Forward Collision-Avoidance Assist may not operate properly in open areas where no objects are detected (e.g. empty parking lot) or when the detecting sensors are blocked right after turning on the engine.
- Forward Collision-Avoidance Assist may not operate properly even after the engine has been restarted when the detecting sensors are blocked or there is a problem with the function.

Limitations of Forward Collision-Avoidance Assist

Forward Collision-Avoidance Assist may not operate normally or may operate unexpectedly if:

- The detecting sensor or the surroundings are contaminated or damaged.
- The temperature around the front view camera is high or low due to surrounding environment.
- The camera lens is contaminated due to tinted, filmed or coated windshield, damaged glass, or sticky foreign material (sticker, bug, etc.) on the glass.
- Moisture is not removed or frozen on the windshield.
- Washer fluid is continuously sprayed, or the wiper is on.
- Driving in heavy rain or snow, or thick fog.
- The field of view of the front view camera is obstructed by sun glare.
- Street light or light from an oncoming traffic is reflected on the wet road surface, such as a puddle on the road.
- An object is placed on the dashboard.

- Your vehicle is being towed.
- The surrounding is very bright.
- The surrounding is very dark, such as in a tunnel, etc.
- The brightness changes suddenly, for example when entering or exiting a tunnel.
- The brightness outside is low, and the headlamps are not on or are not bright.
- Driving through steam, smoke or shadow.
- Only part of the vehicle, powered two-wheeler, pedestrian or cyclist is detected.
- The vehicle in front is a bus, heavy truck, truck with an unusually shaped cargo, trailer, etc.
- The vehicle or powered two-wheeler in front has no tail lights, tail lights are located unusually, etc.
- The brightness outside is low, and the tail lamps are not on or are not bright.
- The rear of the front vehicle is small or the vehicle does not look normal, such as when the vehicle is tilted, overturned, or the side of the vehicle is visible, etc.
- The front vehicle's ground clearance is low or high.
- A vehicle, powered two-wheeler, pedestrian or cyclist suddenly cuts in front.
- The bumper around the front radar is impacted, damaged or the front radar is out of position.
- The temperature around the front radar is high or low.
- Driving through a tunnel or iron bridge.
- Driving in vast areas where there are few vehicles or structures. (for example, desert, meadow, suburb, etc.)
- Driving near areas containing metal substances, such as a construction zone, railroad, etc.
- A material is near that reflects very well on the front radar, such as a guardrail, nearby vehicle, etc.
- The cyclist in front is on a bicycle made of material that does not reflect on the front radar.
- The vehicle or powered two-wheeler in front is detected late.
- The vehicle or powered two-wheeler in front is suddenly blocked by an obstacle.
- The vehicle or powered two-wheeler in front suddenly changes lane or suddenly reduces speed.
- The vehicle or powered two-wheeler in front is bent out of shape.
- The front vehicle or powered two-wheeler speed is fast or slow.
- The vehicle in front steers in the opposite direction of your vehicle to avoid a collision.
- With a vehicle in front, your vehicle changes lane at low speed.
- The vehicle or powered two-wheeler in front is covered with snow.
- You are departing or returning to the lane.
- Unstable driving.
- You are on a roundabout and the vehicle in front is not detected.
- You are continuously driving in a circle.
- The vehicle or powered two-wheeler in front has an unusual shape.
- The vehicle or powered two-wheeler in front is driving uphill or downhill.
- The pedestrian or cyclist is not fully detected, for example, if the pedestrian is leaning over or is not fully walking upright.
- The pedestrian or cyclist is wearing clothing or equipment that makes it difficult to detect.



The illustration above shows the image the front view camera and front radar are capable of detecting as a vehicle, powered two-wheeler, pedestrian and cyclist.

- The pedestrian or cyclist in front is moving very quickly.
- The pedestrian or cyclist in front is short or is posing a low posture.
- The pedestrian or cyclist in front has impaired mobility.
- The pedestrian or cyclist in front is moving intersected with the driving direction.
- There is a group of pedestrians, cyclists or a large crowd in front.
- The pedestrian or cyclist is wearing clothing that easily blends into the background, making it difficult to detect.
- The pedestrian or cyclist is difficult to distinguish from the similarly shaped structure in the surroundings.
- You are driving by a pedestrian, cyclist, traffic signs, structures, etc. near the intersection.
- Driving in a parking lot.
- Driving through a tollgate, construction area, unpaved road, partial paved road, uneven road, speed bumps, etc.
- Driving on an incline road, curved road, etc.
- Driving through a roadside with trees or streetlights.

- The adverse road conditions cause excessive vehicle vibrations while driving.
- Your vehicle height is low or high due to heavy loads, abnormal tire pressure, etc.
- Driving through a narrow road where trees or grass or overgrown.
- There is interference by electromagnetic waves, such as driving in an area with strong radio waves or electrical noise.

WARNING

- **Driving on a curved road**

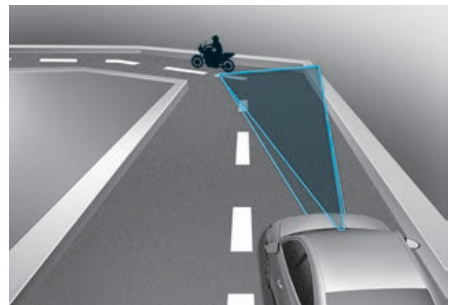
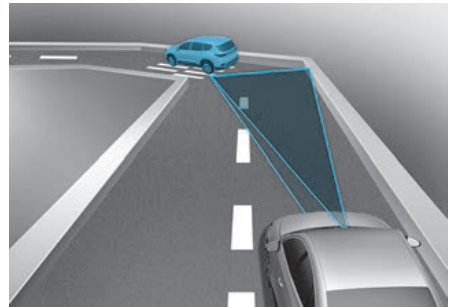

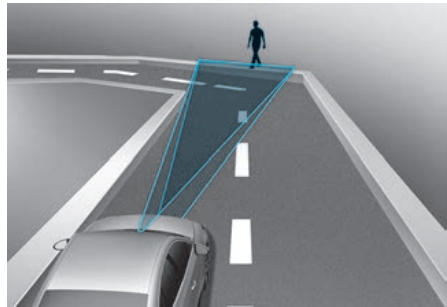
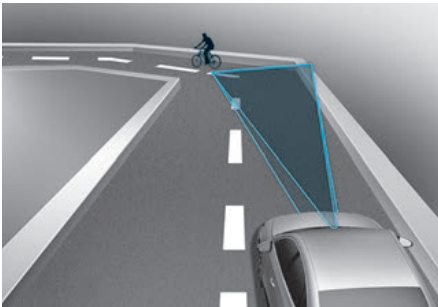
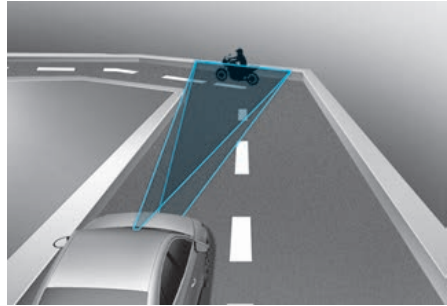
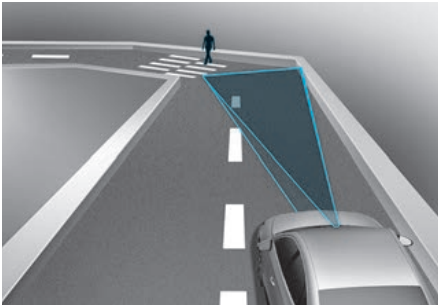

Forward Collision-Avoidance Assist may not detect other vehicles, powered two-wheelers, pedestrians or cyclists in front of you when driving on a curved road adversely affecting the performance of the sensors. This may result in no warning, braking assist when necessary.

When driving on a curved road, always maintain a safe distance from others on the road. Reduce your vehicle speed or steer your vehicle as needed.

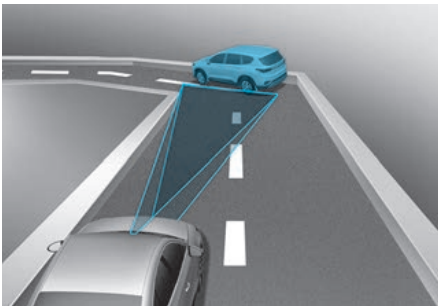
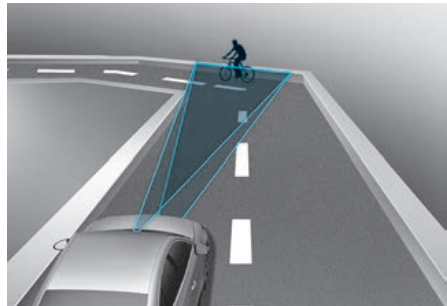

Forward Collision-Avoidance Assist may detect a vehicle, powered two-wheeler, pedestrian or cyclist in the next lane or outside the lane when driving on a curved road.

Always check road conditions, and if necessary, take appropriate actions to drive safely.

- Driving on an inclined road

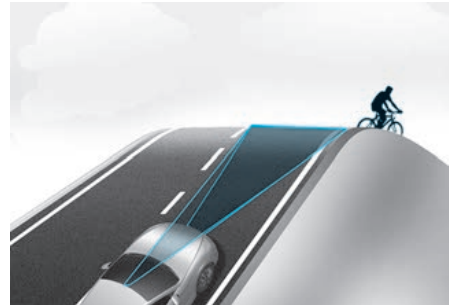
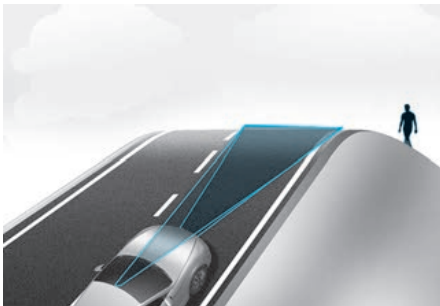
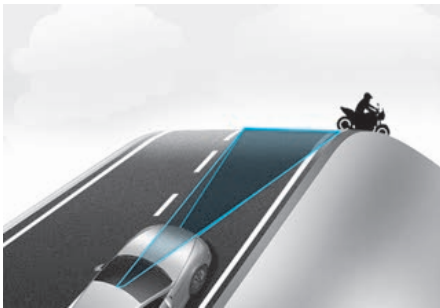
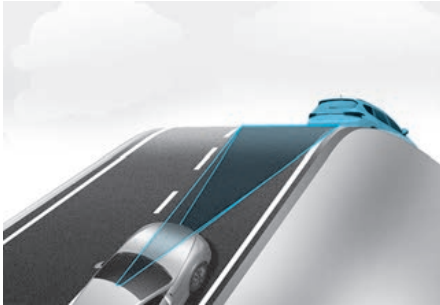

Forward Collision-Avoidance Assist may not detect other vehicles, powered two-wheelers, pedestrians or cyclists in front of you while driving uphill or downhill adversely affecting the performance of the sensors.

This may result in unnecessary warning or braking assist, or no warning or braking assist when needed.

Also, vehicle speed may rapidly decrease when a vehicle, powered two-wheeler, pedestrian or cyclist ahead is suddenly detected. Always maintain a safe distance from the others on the road. Adjust your vehicle speed or steer your vehicle depending on the road conditions.

• Changing lanes

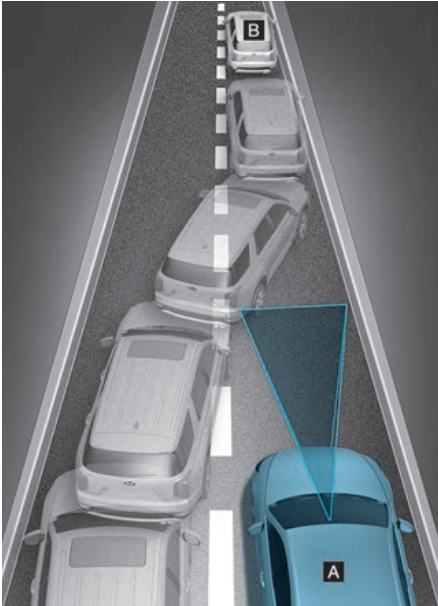

[A] Your vehicle
[B] Lane changing vehicle

When a vehicle moves into your lane from an adjacent lane, it cannot be detected by the sensor until it is within the sensor's detection range. Forward Collision-Avoidance Assist may not immediately detect the vehicle when the vehicle changes lanes suddenly.

Always maintain a safe distance from the vehicles ahead. Adjust your vehicle speed or steer your vehicle depending on the road conditions.

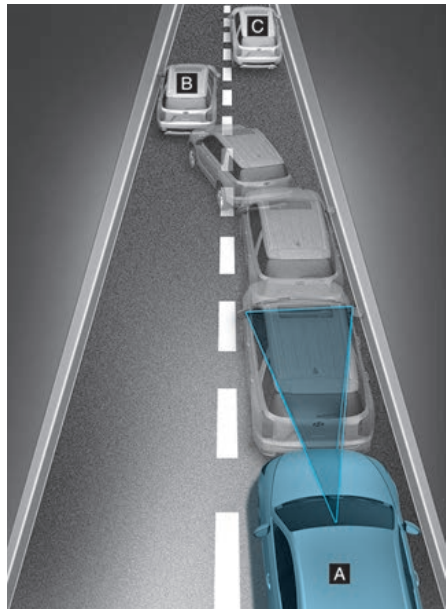

[A] Your vehicle
[B] Lane changing vehicle
[C] Same lane vehicle

When a vehicle in front of you departs the lane, Forward Collision-Avoidance Assist may not immediately detect another vehicle in your lane of travel.

Always maintain a safe distance from the vehicles ahead. Adjust your vehicle speed or steer your vehicle depending on the road conditions.

- **Detecting a vehicle**

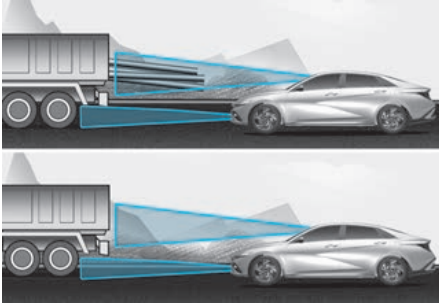

Forward Collision-Avoidance Assist may not be able to detect all potential hazards, like if the vehicle in front of you has cargo that extends rearward past the end of the vehicle or if the vehicle in front of you has higher ground clearance. Always maintain a safe distance from the vehicles ahead. Adjust your vehicle speed or steer your vehicle depending on the road conditions.

WARNING

- When you are towing a trailer or another vehicle, turn off Forward Collision-Avoidance Assist.
- Forward Collision-Avoidance Assist may operate if objects that are similar in shape or characteristics to vehicles, powered two-wheeler, pedestrians and cyclists are detected.
- Forward Collision-Avoidance Assist may not detect bicycles, motorcycles, or smaller wheeled objects such as luggage bags, shopping carts, or strollers.
- Forward Collision-Avoidance Assist may not operate normally if there is interference from strong electromagnetic waves.
- Forward Collision-Avoidance Assist may not operate for 15 seconds right after your vehicle is started or when the front view camera is initialized.

Lane Keeping Assist (LKA)

Lane Keeping Assist uses the front view camera to help detect lane markings (or road edges) while driving over a certain speed. Lane Keeping Assist may warn you if your vehicle leaves the lane without using the turn signal and may steer the vehicle to help prevent it from departing its travel lane.

WARNING

Always monitor your vehicle speed and the distance to vehicles ahead on the road. Lane Keeping Assist is not a substitute for safe driving practices, but a supplemental function only.

Information

Lane Keeping Assist uses the following sensor:

- Front view camera

Refer to the "Driver assistance system sensors" section in this chapter for the location.

Lane Keeping Assist settings

Lane Safety

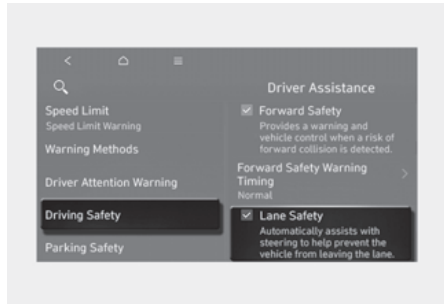

With the ignition switch ON, go to **User Settings > Driver Assistance > Driving Safety > Lane Safety** from the settings menu in the instrument cluster or **Settings > Vehicle > Driver Assistance > Driving Safety > Lane Safety** from the settings menu in the infotainment system to select the following:

If **Lane Safety** is selected, Lane Keeping Assist will automatically assist the driver's steering when lane departure is detected to help prevent the vehicle from moving out of its lane. If **Lane Safety** is deselected, Lane keeping Assist will turn off and the indicator light will turn off the cluster.

WARNING

- Lane Keeping Assist does not control the steering wheel when the vehicle is driven in the middle of the lane.
- The driver should always be aware of the surroundings. If **Lane Safety** is deselected, Lane Keeping assist cannot assist you.

i Information

You can set the following Warning Methods:

- Warning Volume/Haptic Warning/Lane Safety Audible Warning Off/Driving Safety Priority

For more information, refer to the "Driver assistance system settings" section in this chapter.

Lane Keeping Assist operation

Turning Lane Keeping Assist On/Off

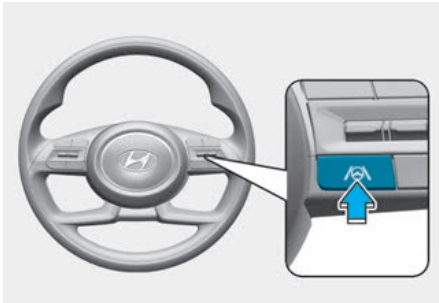

With the engine ON, press and hold the Driving Assist button located on the steering wheel to turn on and off. The grey or green  indicator light illuminates on the instrument cluster when the function is on.

Press and hold the button again to turn off the function.

i Information

- When the engine is restarted, Lane Keeping Assist maintains its last setting.
- When Lane Keeping Assist is turned off by pressing the Lane Driving Assist button, the Lane Safety setting is changed to Off.

Warning and control

Left



Right

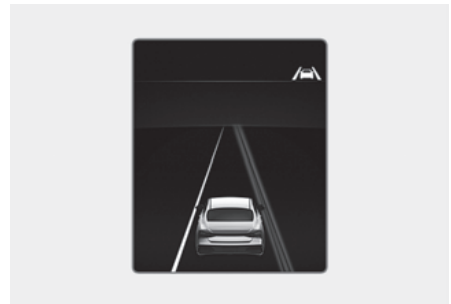

Lane Departure Warning

If the vehicle detects it is departing from the projected lane ahead, the green  indicator light and the lane line blink on the instrument cluster depending on which direction your vehicle is veering, and an audible warning sounds.

- Lane Keeping Assist operates when your vehicle speed is about 40-120 mph (60-200 km/h).

Lane Keeping Assist

If your vehicle detects it is departing from the projected lane ahead, the green  indicator light blinks on the instrument cluster, and the steering wheel makes adjustments to keep your vehicle inside its travel lane.

- Lane Keeping Assist operates when your vehicle speed is about 40-120 mph (60-200 km/h).

Hands-off warning

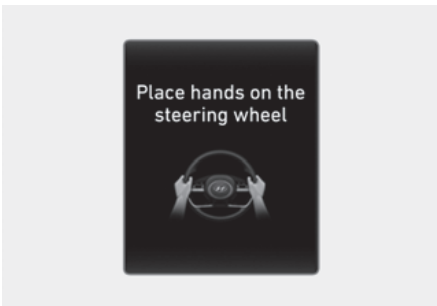

If you take your hands off the steering wheel for several seconds, the **"Place hands on steering wheel"** warning message may appear on the instrument cluster, and an audible warning may sound in successive stages.

WARNING

Lane Keeping Assist may not operate in all situations and cannot avoid all collisions.

To prevent serious injury or death:

- Always steer your vehicle. Lane Keeping Assist is not an autonomous driving system and does not steer your vehicle at all times.
- Lane Keeping Assist may not steer if the steering wheel is held too tightly, or the steering wheel is turned too far left or right.
- If the steering wheel is held very loosely, the hands-off warning message may appear because the Lane Keeping Assist may not recognize that you have your hands on the steering wheel.
- The hands-off warning message may appear late or not at all depending on the road condition.
- If you attach objects to the steering wheel, the hands-off warning may not work properly.

Information

- The status of the Lane Keeping Assist operation appears in Driving Assist mode on the instrument cluster. Refer to the "View modes" section in chapter 4.
- When lane markings (or road edges) are detected, the lane lines on the instrument cluster changes from gray to white. When Lane Keeping Assist is enabled, the green  indicator light illuminates.

Lane undetected



Lane detected



- The images and colors in the instrument cluster may differ depending on the cluster type or theme selected from the settings menu.
- You can steer your vehicle even when steering is assisted by Lane Keeping Assist.
- It may require more or less force to turn the steering wheel when Lane Keeping Assist is providing steering assistance.

Lane Keeping Assist malfunction and limitations

Lane Keeping Assist malfunction

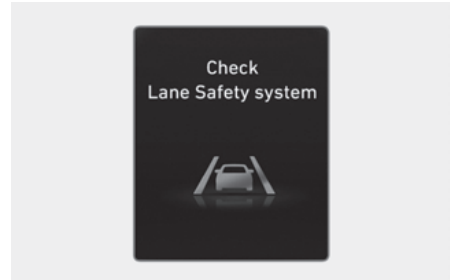

When Lane Keeping Assist is not working properly, the "**Check Lane Safety system**" message may appear and the yellow  indicator light may illuminate on the instrument cluster. Have the vehicle inspected by an authorized HYUNDAI dealer.

Limitations of Lane Keeping Assist

Lane Keeping Assist may not operate normally or may operate unexpectedly if:

- The lane is difficult to distinguish because:
 - The lane markings (or road edge) are damaged or covered with rain, snow, dirt, oil, etc.
 - The color of the lane marking (or road edge) is not distinguishable from the road.
 - There are markings (or road edges) on the road or near the lane that looks similar to the lane markings (or road edge).
- The lane markings are covered by the shadow of objects around the road, such as median strip, guardrails, noise barriers, and trees.
- There are more than two lane markings (or road edges) on the road.

- The lane number increases or decreases, or the lane markings (or road edges) are crossing.
- The lane markings (or road edges) are complicated or a structure substitutes for the lines, such as a construction area or tollbooth area.
- There are road markings, such as zigzag lanes, crosswalk markings and road signs.
- The lane suddenly disappears, such as at the intersection.
- The lane (or road width) is very wide or narrow.
- There is a road edge without a lane.
- There is a boundary structure on the road, such as sidewalk or curb.
- The distance to the front vehicle is extremely short or the vehicle in front is covering the lane marking (or road edge).

i Information

For more information on limitations of the front view camera, refer to the "Forward Collision Avoidance Assist (FCA) (Sensor fusion)" section in this chapter.

! WARNING

- Lane Keeping Assist may be canceled or may not work properly depending on the road conditions and the surroundings.
 - When you are towing a trailer or another vehicle, turn off Lane Keeping Assist.
 - If your vehicle is driven at high speeds, Lane Keeping Assist may not steer the vehicle.
 - When other system's warning message appears or audible warning is heard, Lane Keeping Assist may not warn you.
 - You may not hear the audible warning of Lane Keeping Assist if the surrounding environment is too noisy.
 - Lane Keeping Assist may not operate for 15 seconds right after your vehicle is started or when the front view camera is initialized.
 - Lane Keeping Assist does not operate when:
 - Either the turn signal or hazard warning flasher is turned on.
 - Your vehicle is not driven in the center of the lane after turning on Lane Keeping Assist or after changing lanes.
 - ESC (Electronic Stability Control) or VSM (Vehicle Stability Management) is controlling the brake force to the wheels.
 - Your vehicle is driven on sharp curves.
 - Driving below 35 mph (55 km/h) or above 130 mph (210 km/h).
 - Your vehicle makes sharp lane changes.
 - Your vehicle brakes suddenly.
-

Blind-spot Collision-Avoidance Assist (BCA)

 if equipped

Blind-Spot Collision-Avoidance Assist uses the front view camera and the rear corner radar to help detect approaching vehicles in the driver's blind spot areas and warn you of a possible collision with a warning message and audible warning.

If there is a collision risk when driving forward out of a parking space, Blind-Spot Collision-Avoidance Assist may brake your vehicle to help avoid a collision.

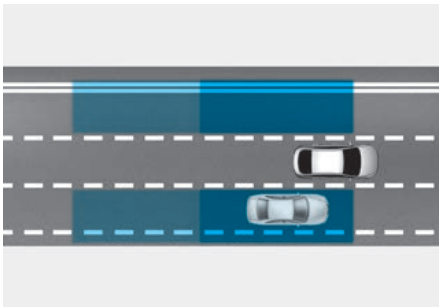

Blind-Spot Collision-Avoidance Assist helps detect and warns you that a vehicle is in the blind spot area.

WARNING

The detecting range may differ depending on the speed of your vehicle. Vehicles in the blind spot area may not be detected by Blind-Spot Collision-Avoidance Assist when you pass other vehicles at high speeds.

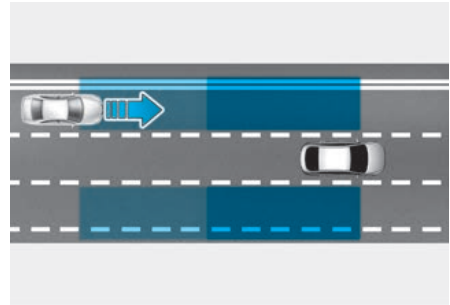

Blind-Spot Collision-Avoidance Assist helps detect and warns you that a vehicle is approaching at high speed from the blind spot area.

CAUTION

The warning timing may differ depending on the speed of the vehicle approaching you at high speed.

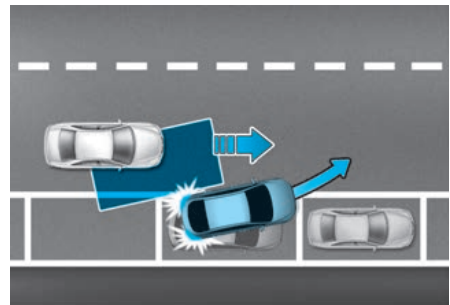

Blind-Spot Collision-Avoidance Assist may brake your vehicle if there is a detected collision risk when driving forward out of a parking space.

i Information

Blind-Spot Collision-Avoidance Assist uses the following sensors:

- Front view camera
- Rear corner radars

Refer to the "Driver assistance system sensors" section in this chapter for the location.

Blind-spot Collision-Avoidance Assist settings

Blind-Spot Safety

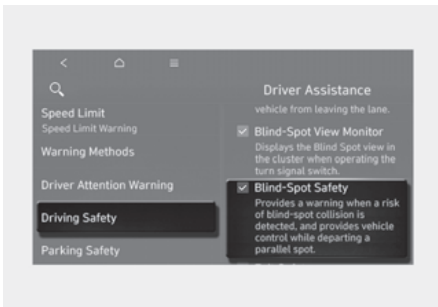

With the ignition switch ON, go to **User settings > Driver Assistance > Driving Safety > Blind-Spot Safety** from the settings menu in the instrument cluster or **Settings > Vehicle > Driver Assistance > Driving Safety > Blind-Spot Safety** from the settings menu in the infotainment system to select the following:

If **Blind-Spot Safety** is selected, Blind-Spot Collision-Avoidance Assist will warn the driver with a warning message, an audible warning depending on the collision risk

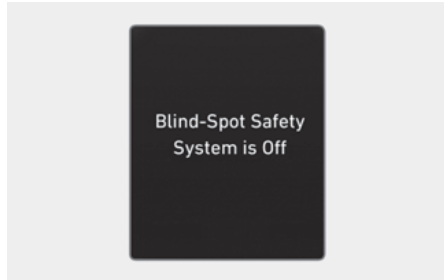

When the engine is restarted with Blind-Spot Collision-Avoidance Assist off, the "**Blind-Spot Safety System is Off**" message will appear on the instrument cluster. If you select Blind-spot safety, warning light on the side view mirror will blink for three seconds. In addition, if the vehicle is turned on, when Blind-Spot Safety is selected, the warning light on the side view mirror will blink for three seconds.

! WARNING

The driver should always be aware of the surroundings and drive safely. If **Blind-spot safety** is deselected, Blind-Spot Collision-Avoidance Assist cannot assist you.

i Information

When the engine is restarted, Blind-Spot Collision-Avoidance Assist maintains its last setting.

i Information

You can set the Warning Timing and following Warning Methods:

- Warning Volume/Haptic Warning/Driving Safety Priority

For more information, refer to the "Driver assistance system settings" section in this chapter.

Blind-spot Collision-Avoidance Assist operation

Driving-Warning



Vehicle detection

When a vehicle is detected in a blind spot, the warning light on the side view mirror illuminates.

- Vehicle detection operates when your vehicle speed is above 12 mph (20 km/h) and the speed of the vehicle in the blind spot area is above 6 mph (10 km/h).

Collision warning

Collision warning may operate when the turn signal is turned on in the direction of a detected vehicle.

- To warn you of a potential collision, the warning light on the side view mirror may blink and an audible warning may sound.
- When the turn signal is turned off or you move away from the vehicle in the blind spot, the function returns to vehicle detection state.
- Collision warning may warn when your vehicle speed is above 25 mph (40 km/h) and the speed of the vehicle in the blind spot area is above 6 mph (10 km/h).

WARNING

- The detection range of the rear corner radar is determined by a standard road width. On narrow roads, the function may detect other vehicles in the next lane and warn you. On wide roads, the function may not be able to detect a vehicle driving in the next lane and may not warn you.
- When the hazard warning flasher is on, the collision warning initiated by activating the turn signal may not operate.

Collision-avoidance assist (while parallel parking exit)



To warn you of a potential collision, the warning light on the side view mirror may blink, a warning message may appear on the instrument cluster, and an audible warning may sound.

- Blind-Spot Collision-Avoidance Assist operates when your vehicle speed is below 2 mph (3 km/h) and the speed of the vehicle in the blind spot area is above 3 mph (5 km/h).
- Blind-Spot Collision-Avoidance Assist may assist with braking your vehicle to avoid a collision.



After your vehicle is stopped following an Emergency Braking event, the "Drive carefully" warning message may appear on the instrument cluster.

Depress the brake pedal immediately and check the surroundings.

- Braking control ends about 2 seconds after your vehicle is stopped following an Emergency Braking event.

WARNING

Blind-Spot Collision-Avoidance Assist may not operate in all situations and cannot avoid all collisions.

To prevent serious injury or death:

- Only change the settings after parking your vehicle at a safe location.
- Blind-Spot Collision-Avoidance Assist may not operate if the function determines you have depressed the brake pedal sufficiently in response to the potential hazard detected by the function.
- If Blind-Spot Collision-Avoidance Assist is assisting to brake your vehicle and you excessively depress the accelerator pedal or sharply steer your vehicle, it stops assisted braking.
- During Blind-Spot Collision-Avoidance Assist operation, your vehicle may stop suddenly. Always wear your seat belt, check your passengers have their seat belts fastened and secure loose objects that may become projectiles.

- Even if there is a problem with Blind-Spot Collision-Avoidance Assist, your vehicle's braking system operates normally.
- Control your vehicle at all times. Always maintain a safe distance from the vehicles ahead and adjust your vehicle speed depending on the road conditions.
- Never attempt to activate Blind-Spot Collision-Avoidance Assist by intentionally driving toward people, animals, objects, or other vehicles.
- When other system's warning message appears or audible warning is heard, Blind-Spot Collision-Avoidance Assist may not warn you.
- You may not hear the audible warning of Blind-Spot Collision-Avoidance Assist if the surrounding environment is too noisy.

WARNING

Braking is not assisted and only a warning is provided when:

- The ESC (Electronic Stability Control) warning light is on.
- ESC (Electronic Stability Control) is controlling the brake force to the wheels.

Information

The images and colors in the instrument cluster may differ depending on the cluster type or theme selected from the settings menu.

Blind-spot Collision-Avoidance Assist malfunction and limitations

Blind-Spot Collision-Avoidance Assist malfunction

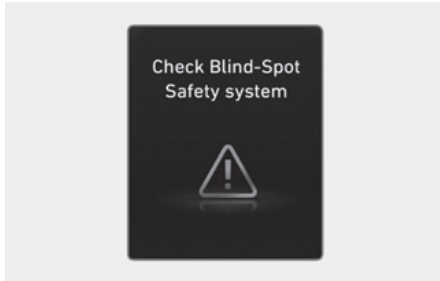

When Blind-Spot Collision-Avoidance Assist is not working properly, the "**Check Blind-Spot Safety system**" warning message will appear on the instrument cluster for several seconds, and the master (⚠) warning light will appear on the instrument cluster. Have the vehicle be inspected by an authorized HYUNDAI dealer.

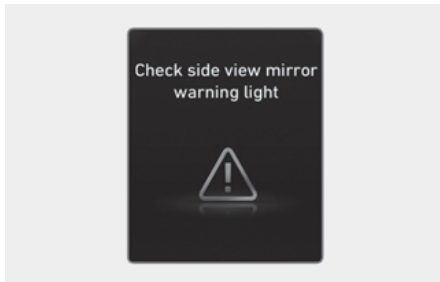

When the side view mirror warning light is not working properly, the "**Check side view mirror warning light**" warning message will appear on the instrument cluster for several seconds, and the master (⚠) warning light will illuminate on the instrument cluster. Have the vehicle inspected by an authorized HYUNDAI dealer.

Blind-Spot Collision-Avoidance Assist disabled

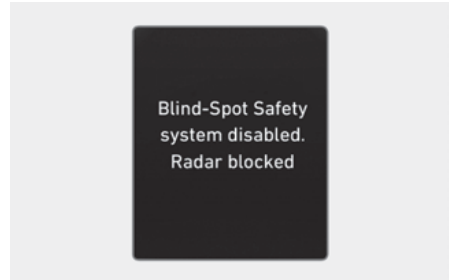

If the rear corner radar is blocked or covered, or when the rear bumper around the rear corner radar or sensor is covered by any foreign material, such as snow, rain, or dirt, or when a trailer or hitch mounted carrier is installed, the detecting performance may decrease and temporarily limit or disable Blind-Spot Collision-Avoidance Assist.

The "**Blind-Spot Safety system disabled. Radar blocked**" warning message may appear on the instrument cluster.

The function operates normally when such foreign material, trailer, or carrier is removed, and the engine is restarted.

If the function does not operate normally after anything covering or blocking the sensors is removed, have the vehicle inspected by an authorized HYUNDAI dealer.



WARNING

- Blind-Spot Collision-Avoidance Assist may not operate properly even if there is no warning message or warning light on the instrument cluster.
- Blind-Spot Collision-Avoidance Assist may not operate properly in open areas where no objects are detected (e.g. empty parking lot) or when the detecting sensors are blocked right after turning on the engine.
- Always turn off Blind-Spot Collision-Avoidance Assist when towing a trailer or using a hitch mounted carrier.

Limitations of Blind-Spot Collision-Avoidance Assist

Blind-Spot Collision-Avoidance Assist may not operate normally or the function may operate unexpectedly if:

- There is inclement weather, such as heavy snow, heavy rain, etc.
- The rear corner radar or the area near the rear corner radar is covered by snow, water, or dirt.
- The rear corner radar or the area near the rear corner radar is blocked by a vehicle, wall, or pillar.
- The temperature near the rear corner radar is very hot or cold.
- You are driving on a highway access road or through a tollbooth.
- The road pavement (or the ground near your vehicle) contains metallic components (i.e. possibly due to subway construction).
- There is a fixed object near your vehicle, such as sound barriers, guardrails, central dividers, entry barriers, streetlights, signs, tunnels, walls, etc.
- You are driving on a narrow road where trees or grass are overgrown.

- You are driving in large, open areas where there are few vehicles or structures (e.g. desert, meadow, empty parking lot).
- You are driving on a wet road.
- The other vehicle drives very close behind your vehicle, or passes by your vehicle in close proximity.
- The speed of the other vehicle is so fast that it passes by your vehicle in a short time.
- Your vehicle passes another vehicle.
- Your vehicle changes lanes.
- Your vehicle has started at the same time as the vehicle next to you and has accelerated.
- The vehicle in the next lane moves two lanes away from you, or the vehicle moves two lanes away to the next lane.
- A trailer or hitch mounted carrier is installed and it blocks the rear corner radar.
- The area near the rear corner radar is covered with objects, such as bumper sticker, bumper guard, bike rack, etc.
- The bumper around the rear corner radar has been damaged or modified, and the radar is out of position.
- Your vehicle height is lower or higher than normal due to heavy loads, abnormal tire pressure, etc.

Blind-Spot Collision-Avoidance Assist may not operate normally or may operate unexpectedly when the following objects are detected:

- A motorcycle or bicycle
- A vehicle such as flat trailer
- A big vehicle such as bus or truck
- A moving obstacle such as pedestrian, animal, shopping cart, or baby stroller
- A vehicle with lower height, such as sports car

Blind-Spot Collision-Avoidance Assist may not assist braking when:

- Your vehicle severely vibrates while driving over a bumpy road, uneven road, or concrete patch.
- You are driving on a slippery surface due to snow, water puddle, ice, etc.
- The tire pressure is low or any tire is damaged.
- There is an issue with the braking system.
- Your vehicle makes abrupt lane changes.

i Information

For more information on limitations of the front view camera, refer to the "Forward Collision Avoidance Assist (FCA) (Sensor fusion)" section in this chapter.

⚠ WARNING

- **Driving on a curved road**

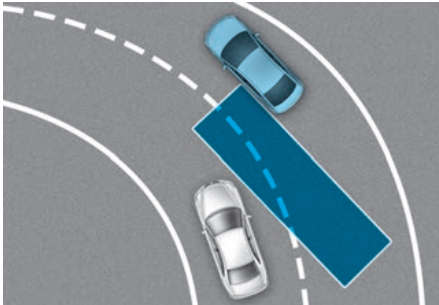

Blind-Spot Collision-Avoidance Assist may not detect a vehicle in an adjacent lane when driving on a curved road and may not activate a warning or brake your vehicle.

Always check road conditions, and if necessary, take appropriate actions to drive safely.

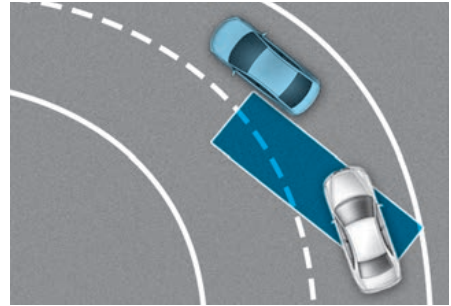

Blind-Spot Collision-Avoidance Assist may detect a vehicle in the same lane when driving on a curved road and activate a warning or brake your vehicle.

Always check road conditions, and if necessary, take appropriate actions to drive safely.

- **Driving where the road is merging/dividing**

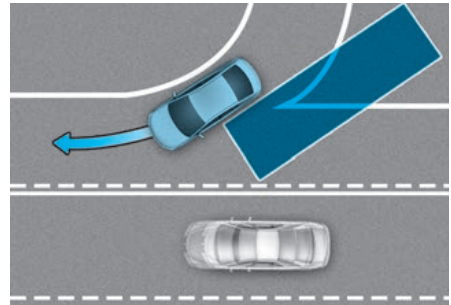

Blind-Spot Collision-Avoidance Assist may not detect a vehicle in an adjacent lane when the road merges or divides and may not activate a warning or brake your vehicle.

Always check road conditions, and if necessary, take appropriate actions to drive safely.

- **Driving on hills**

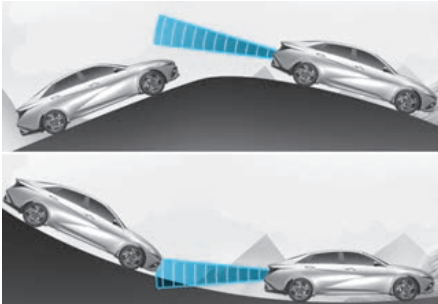

Blind-Spot Collision-Avoidance Assist may not detect a vehicle in an adjacent lane or may incorrectly detect the ground or another object when driving on hills and activate a warning or brake your vehicle.

Always check road conditions, and if necessary, take appropriate actions to drive safely.

- **Driving where the heights of the lanes are different**

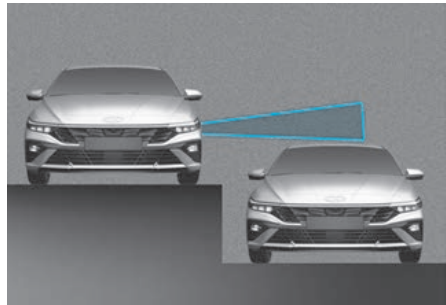

Blind-Spot Collision-Avoidance Assist may not operate properly when driving where the heights of the lanes are different. The function may not detect a vehicle on a road with a different lane height (underpass joining section, grade separated intersections, etc.) and not activate a warning or brake your vehicle.

Always check road conditions, and if necessary, take appropriate actions to drive safely.

 **WARNING**

- Blind-Spot Collision-Avoidance Assist may not operate normally if there is interference from strong electromagnetic waves.
- Blind-Spot Collision-Avoidance Assist may not operate right after your vehicle is started or when the front view camera and rear corner radars are initialized.

Safe Exit Warning (SEW)

 if equipped

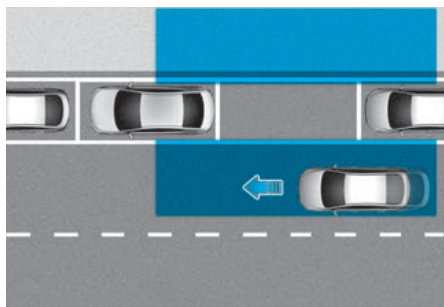

Safe Exit Warning uses the rear corner radars to help detect a vehicle approaching the rear of your vehicle, after the vehicle is stopped and a passenger opens a door.

If Safe Exit Warning is activated, an audible warning sounds and a warning message may appear on the instrument cluster.

The warning timing may differ depending on the speed of the detected vehicle.

i Information

Safe Exit Warning uses the following sensor:

- Rear corner radars

Refer to the "Driver assistance system sensors" section in this chapter for the location.

Safe Exit Warning settings

Exit Warning

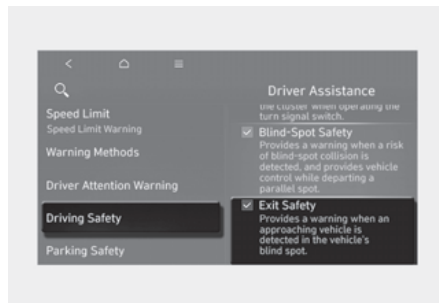

With the ignition switch ON, go to **User settings > Driver Assistance > Driving Safety > Exit Safety** from the settings menu in the instrument cluster or **Settings > Vehicle > Driver Assistance > Driving Safety > Exit Safety** from the Settings menu in the infotainment system to turn this function on and off.

WARNING

The driver should always be aware of unexpected and sudden situations from occurring. If **Exit Safety** is deselected, Safe Exit Warning cannot assist you.

i Information

When the engine is restarted, Safe Exit Warning maintains the last setting.

i Information

You can set the following Warning Methods:

- Warning Volume/Driving Safety Priority
- For more information, refer to the "Driver assistance system settings" section in this chapter.

Safe Exit Warning operation

Collision warning when exiting your vehicle

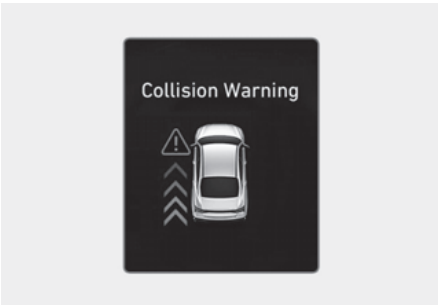

When an approaching vehicle from the rear is detected while a door is being opened, the warning light on the side view mirror may blink, a warning message may appear on the instrument cluster, and an audible warning may sound.

- Safe Exit Warning may warn you when your vehicle speed is below 2 mph (3 km/h), and the speed of the vehicle approaching the rear of your vehicle is above 4 mph (6 km/h).

WARNING

Safe Exit Warning may not operate in all situations and cannot avoid all collisions.

To prevent serious injury or death:

- Always check the surroundings before you or your passengers exit your vehicle.
- Only change the settings after parking your vehicle at a safe location.
- When other system's warning message appears or audible warning is heard, Safe Exit Warning may not warn you.
- You may not hear the audible warning of Safe Exit Warning if the surrounding environment is too noisy.
- Safe Exit Warning may stop operating, or may not operate, or operate unnecessarily depending on the road conditions and surroundings.

Information

- After the engine is turned off, Safe Exit Warning may detect approaching vehicles for up to 10 minutes, but does not function after the doors are locked.
- The images and colors in the instrument cluster may differ depending on the cluster type or theme selected from the settings menu.

Safe Exit Warning malfunction and limitations

Safe Exit Warning malfunction

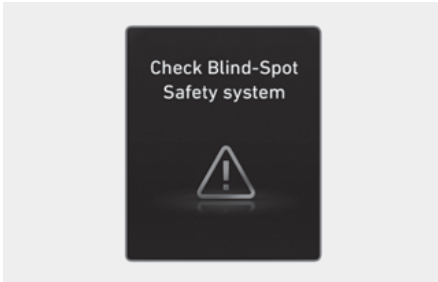

When Safe Exit Warning is not working properly, the "**Check Blind-Spot Safety system**" warning message will appear on the instrument cluster for several second, and the master (⚠) warning light will appear on the instrument cluster. Have the vehicle inspected by an authorized HYUNDAI dealer.

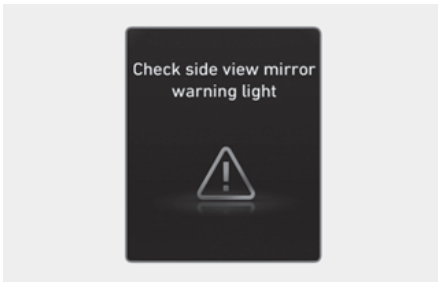

When the side view mirror warning light is not working properly, the "**Check side view mirror warning light**" warning message will appear on the instrument cluster for several seconds, and the master (⚠) warning light will illuminate on the instrument cluster. Have the vehicle inspected by an authorized HYUNDAI dealer.

Safe Exit Warning disabled

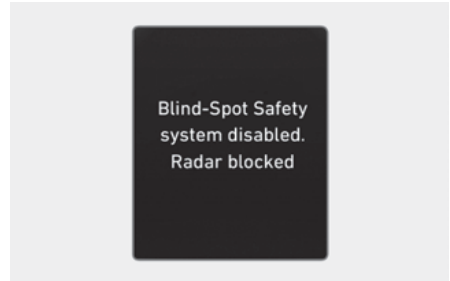

If the rear corner radar is blocked or covered, or when the rear bumper around the rear corner radar or sensor is covered by any foreign material, such as snow, rain, or dirt, or when a trailer or hitch mounted carrier is installed, the detecting performance may decrease and temporarily limit or disable Safe Exit Warning.

The "**Blind-Spot Safety system disabled. Radar blocked**" warning message may appear on the instrument cluster.

The function operates normally when such foreign material, trailer, or carrier is removed, and the engine is restarted.

If the function does not operate normally after anything covering or blocking the sensors is removed, have the vehicle inspected by an authorized HYUNDAI dealer.

 **WARNING**

- Safe Exit Warning may not operate properly even if there is no warning message or warning light on the instrument cluster.
 - Safe Exit Warning may not operate properly in open areas where no objects are detected (e.g. empty parking lot) or when the detecting sensors are blocked right after turning on the engine.
 - Turn off Safe Exit Warning when towing a trailer or using a hitch mounted carrier.
-

Limitations of Safe Exit Warning

Safe Exit Warning may not operate normally, or may operate unexpectedly if:

- Trees or grass near your vehicle are overgrown.
- The road is wet.
- The approaching vehicle is very fast or slow.

 **Information**

For more information on the limitations on the rear corner radar, refer to the "Blind-spot Collision-Avoidance Assist (BCA)" section in this chapter.

 **WARNING**

- Safe Exit Warning may not operate if there is interference from strong electromagnetic waves.
 - Safe Exit Warning may not operate for 3 seconds right after your vehicle is started or when the rear corner radars are initialized.
 - Safe Exit Warning may not operate properly even after the engine has been restarted when the detecting sensors are blocked or there is a problem with the function.
-

Manual Speed Limit Assist (MSLA)



- (1) Manual Speed Limit Assist enabled indicator
- (2) Set speed

Manual Speed Limit Assist allows you to set a self-imposed maximum speed limit. If you drive over the set speed, Manual Speed Limit Assist blinks and chimes until your vehicle speed decreases below the set speed.

Manual Speed Limit Assist operation

Setting speed limit

1. Press and hold the Driving Assist (MODE) button at the desired speed. The Manual Speed Limit Assist (LIMIT) indicator light illuminates on the instrument cluster.

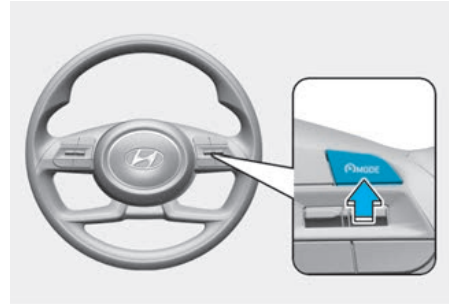

2. Push the + switch up or - switch down to change the set speed.

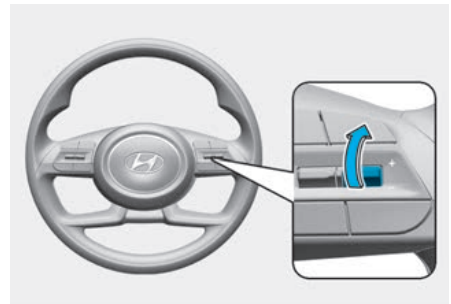

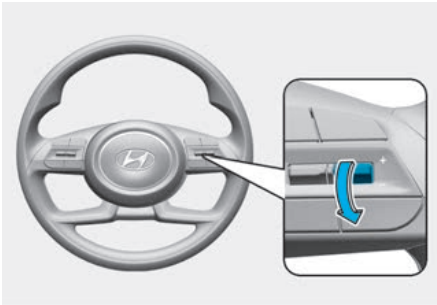

Push and hold to increase or decrease to the nearest multiple of five (multiple of ten in km/h), and then increase or decrease by 5 mph (10 km/h).



3. Check the set speed limit on the instrument cluster.
The set speed limit blinks and chime sounds until your vehicle speed decreases below the set speed limit.

i Information

When the accelerator pedal is not depressed beyond the pressure point, vehicle speed will maintain within the speed limit.

Temporarily pausing Manual Speed Limit Assist

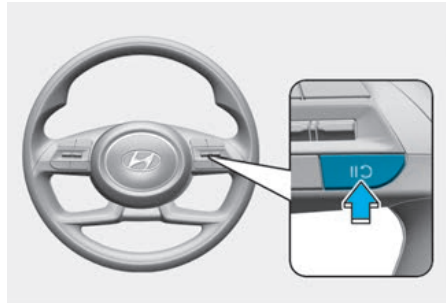

Press the **II** button to temporarily cancel the set speed limit. The set speed turns off, but the Manual Speed Limit Assist (LIMIT) indicator light stays on.

Resuming Manual Speed Limit Assist

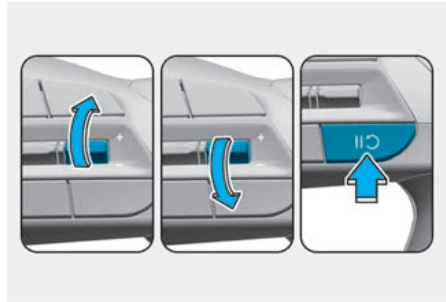

Push the +/- switch or **II** button.

If you push the + switch up or - switch down, the set speed is set to the current speed.

If you press the **II** button, the set speed resumes to the previously set speed limit.

Turning off Manual Speed Limit Assist

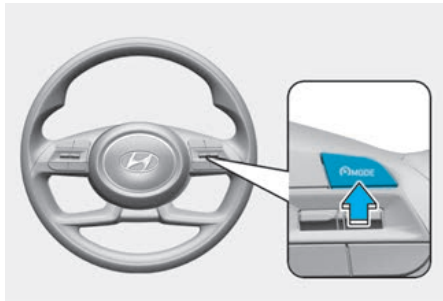

Press the Driving Assist (MODE) button to turn off Manual Speed Limit Assist off. The Manual Speed Limit Assist (LIMIT) indicator light turns off.

Always press the Driving Assist (MODE) button to turn off Manual Speed Limit Assist when not in use.

! WARNING

To prevent serious injury or death:

- Set your vehicle speed to the speed limit for the road and use the appropriate unit (mph or km/h) for your country.
- Keep Manual Speed Limit Assist off when not in use, to avoid inadvertently setting a speed. Check that the Manual Speed Limit Assist (LIMIT) indicator light is off.
- Always drive defensively and pay attention to the driving task.

Intelligent Speed Limit Assist (ISLA)

+ if equipped

Intelligent Speed Limit Assist uses information of road signs detected from the front view camera and uses the navigation system data to inform you of the speed limit and help maintain within the speed limit on the road.

! WARNING

- Intelligent Speed Limit Assist may not display the correct speed limit or may not properly control the driving speed because it is a supplemental function to inform you of the speed limit on the road.
- Set your vehicle speed to the speed limit for the road and use the appropriate unit (mph or km/h) for your country.
- Intelligent Speed Limit Assist may not operate properly if used in other countries.
- Intelligent Speed Limit Assist may not operate properly if the navigation system is not updated regularly. (for navigation applied vehicles)

i Information

Intelligent Speed Limit Assist uses the following sensor:

- Front view camera

Refer to the "Driver assistance system sensors" section in this chapter for the location.

Intelligent Speed Limit Assist settings

Speed Limit

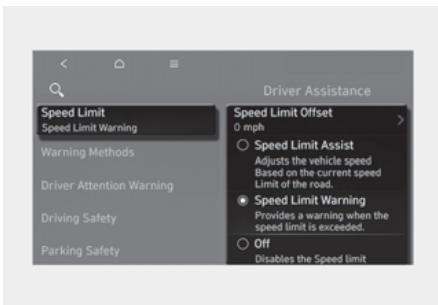
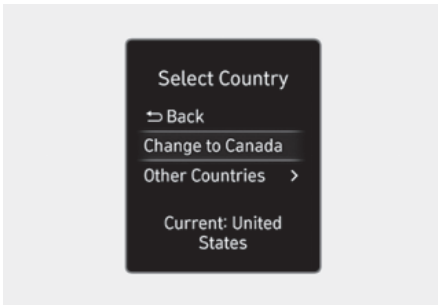

With the ignition switch ON, select or deselect **User Settings > Driver Assistance > Speed Limit** from the User Settings menu in the instrument cluster or **Settings > Vehicle > Driver Assistance > Speed Limit** from the Settings menu in the infotainment system to set whether to use each function.

- **Select Country:** When the navigation system is not available, you can manually select the country to set the speed limit from the User Settings menu in the instrument cluster.

- **Speed Limit Assist:** Intelligent Speed Limit Assist will inform the driver of speed limit and additional road signs. In addition, Intelligent Speed Limit Assist will inform the driver to change set speed of Manual Speed Limit Assist and/or Smart Cruise Control to help the driver stay within the speed limit.
- **Speed Limit Warning:** Intelligent Speed Limit Assist will inform the driver of speed limit. In addition, Intelligent Speed Limit Assist will warn the driver when the vehicle is driven faster than the speed limit.
- **Off:** Intelligent Speed Limit Assist will turn off.

Intelligent Speed Limit Assist operation

Intelligent Speed Limit Assist may warn and control your vehicle by "Displaying speed limit", "Warning overspeed", and "Changing set speed".

i Information

Intelligent Speed Limit operation is described based on the offset adjusted to "0". For more information on setting the offset, refer to "Intelligent Speed Limit Assist settings" in this section.

Displaying speed limit



Speed limit information appears on the instrument cluster.

- If the speed limit information of the road cannot be recognized, "---" appears.
- Intelligent Speed Limit Assist provides additional road sign information in addition to speed limit information. Additional road sign information provided may differ depending on your country.
- The images and colors in the instrument cluster may differ depending on the cluster type or theme selected from the settings menu.

Warning overspeed



When driving at a speed higher than the displayed speed limit, the speed limit appears in red.

Changing set speed

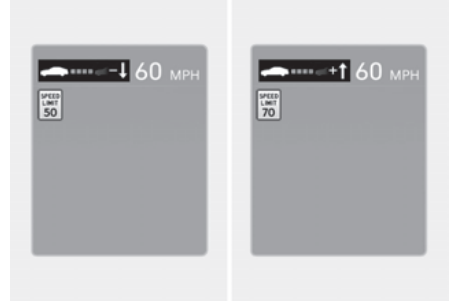

If the speed limit changes when using Manual Speed Limit Assist or Smart Cruise Control, an arrow in the direction of up or down appears to inform you to change the set speed by pushing the + or - switch.

Set Speed Auto Change (Navigation equipped)



Manual Speed Limit Assist or Smart Cruise Control assists the vehicle to adjust its speed according to the speed limit. When the cruising speed is set as same as the speed limit, the vehicle automatically adjusts its speed if the speed limit changes. The function operates on the road which has a speed limit of 44 mph (70 km/h) or higher. When the function is active, the cruising speed on the instrument cluster appears in green.

 **WARNING**

- If you want to drive below the speed limit, set the Speed Limit Offset under "0" or use the - switch on the steering wheel to lower the set speed. If the Speed Limit Offset is set over "0", the set speed changes to a speed higher than the limit for the road.
- If necessary, reduce your driving speed as needed. Even after changing the set speed according to the speed limit for the road, your vehicle can still be driven over the speed limit.
- If the speed limit for the road is under 20 mph (30 km/h), the set speed changing function does not work.
- Intelligent Speed Limit Assist operates using the speed unit set by you from the settings menu. If the speed unit is set to a unit other than the speed unit used in your country, Intelligent Speed Limit Assist may not operate properly.

 **Information**

- For more information on Manual Speed Limit Assist operation, refer to the "Manual Speed Limit Assist (MSLA)" section in this chapter.
- For more information on Smart Cruise Control operation, refer to the "Smart Cruise Control (SCC)" section in this chapter.

Intelligent Speed Limit Assist malfunction and limitations

Intelligent Speed Limit Assist malfunction

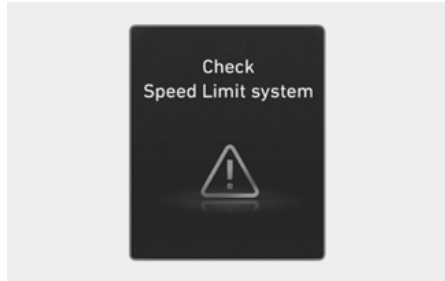

When Intelligent Speed Limit Assist is not working properly, the "**Check Speed Limit Assist System**" warning message may appear, and the () warning light may illuminate on the instrument cluster. Have the vehicle inspected by an authorized HYUNDAI dealer.

Intelligent Speed Limit Assist disabled

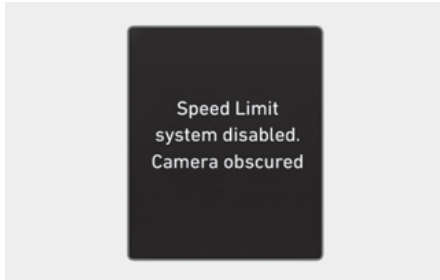

If the front view camera is covered or blocked, its detecting performance is reduced, and Intelligent Speed Limit Assist is temporarily limited or disabled.

The "**Speed Limit Assist system disabled. Camera obscured**" warning message may appear on the instrument cluster.

If Intelligent Speed Limit Assist does not operate normally after the sensor has been uncovered or unblocked, have the vehicle inspected by an authorized HYUNDAI dealer.

WARNING

Intelligent Speed Limit Assist may not operate properly even if there is no warning message or warning light on the instrument cluster.

Limitations of Intelligent Speed Limit Assist

Intelligent Speed Limit Assist may not operate or may be limited if:

- The road sign is damaged, difficult to see due to rain, snow, fog, dirt, sand, oil, etc., or obscured by surrounding objects or shadows.
- The road signs do not conform to the standard designs in your country.
 - The text or picture on the road sign is different from the standard designs in your country.
 - The road sign is installed between the main road and exit road or between diverging roads.
 - A sign is attached to another vehicle.
- The distance between the driving lane and road sign is far.
- There are LED road signs.
- The numbers or pictures in the road sign is incorrectly recognized as the speed limit.
- Road signs on adjacent roads are incorrectly recognized as road signs you are driving on.
- Multiple signs are installed close together.
- Supplementary road signs or signboards are installed near the road sign.
- A minimum speed limit sign is incorrectly recognized as the maximum speed limit sign.
- The brightness changes suddenly, for example when entering or exiting a tunnel or passing under a bridge.
- Headlights are not used, or the brightness of the headlights are weak at night or in the tunnel.
- Road signs are difficult to recognize due to the reflection of sunlight, streetlights, or oncoming vehicles.
- The front view camera's field of view is obstructed by glare from the sun.

- You are driving on a road that is sharply curved or continuously curved.
- You are driving through speed bumps, or driving up and down, or left to right on steep inclines.
- Your vehicle is shaking heavily.
- There is an error in the navigation map data or GPS data.
- You are not driving your vehicle based on the route guidance.
- You are driving your vehicle on a newly opened road.
- The navigation system is updated while driving or restarts.

i Information

For more information on the limitations of the front view camera, refer to the "Forward Collision Avoidance Assist (FCA) (Front view camera only)" section in this chapter.

Driver Attention Warning (DAW)

Basic function

Driver Attention Warning uses the front view camera to help monitor your driving pattern and uses the driving time to recommend a break.

Leading Vehicle Departure Alert function

Leading Vehicle Departure Alert function informs you when a detected vehicle in front departs from a stop.

i Information

Driver Attention Warning uses the following sensor:

- Front view camera

Refer to the "Driver assistance system sensors" section in this chapter for the location.

Driver Attention Warning settings

With the ignition switch ON, go to **User Settings > Driver Assistance > Driver Attention Warning** from the settings menu in the instrument cluster or **Settings > Vehicle > Driver Assistance > Driver Attention Warning** from the settings menu in the infotainment system to set the following:

Leading Vehicle Departure Alert

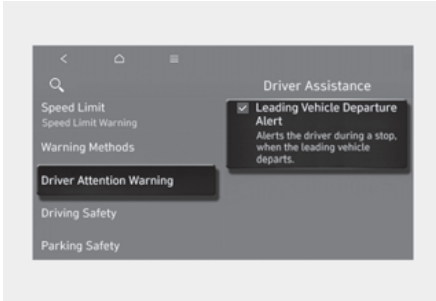

If Leading Vehicle Departure Alert is selected, the function informs you when a detected vehicle in front departs from a stop.

i Information

When the engine is restarted, Driver Attention Warning maintains the last setting.

i Information

You can change the Warning Timing settings or select Driving Safety Priority for Driver Attention Warning from the Settings menu. For more information, refer to the "Driver assistance system settings" section in this chapter.

Driver Attention Warning operation

Basic function

The basic function of Driver Attention Warning is to warn the driver "**Consider taking a break**".

Taking a break

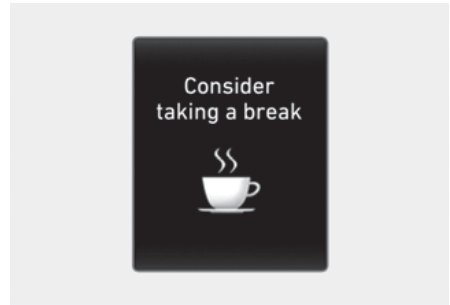

- The "**Consider taking a break**" message and Driver Attention Warning light (☹️) will appear on the cluster and an audible warning will sound to suggest that the driver take a break, when the driver's attention level is below 1.
- Driver Attention Warning will not suggest a break when the total driving time is shorter than 4 minutes or 4 minutes has not passed after the last break was suggested.
- A break is suggested when your vehicle speed is between approximately 0-120 mph (0-200 km/h).

WARNING

For your safety, only change the Settings after parking the vehicle at a safe location.

⚠ CAUTION

- Driver Attention Warning may suggest a break depending on your driving pattern or habit, even if you do not feel fatigued.
 - Driver Attention Warning is a supplemental function only and does not determine if you are paying attention to the driving task.
 - If you feel fatigued or want to take a break, do so as needed at a safe location.
-

i Information

- The status of the Driver Attention Warning appears in Driving Assist mode on the instrument cluster. Refer to the "View modes" section in chapter 4.
 - Driver Attention Warning resets the last break time to 00:00 when:
 - The engine is turned off.
 - The driver's seat belt is unfastened, and the driver's door is opened.
 - The vehicle is stopped for more than 10 minutes.
-

Leading Vehicle Departure Alert function

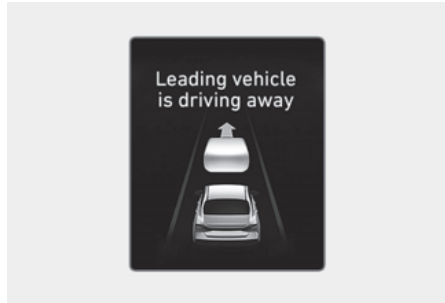

Departure Alert displays the "**Leading vehicle is driving away**" message on the instrument cluster and an audible warning sounds.

⚠ WARNING

- When other system's warning message appears or audible warning is heard, Leading Vehicle Departure Alert may not alert you.
 - Always check road conditions, and if necessary, take appropriate actions to drive safely. It is your responsibility to operate your vehicle in a safe manner.
-

⚠ CAUTION

- Leading Vehicle Departure Alert is a supplemental function and may not alert you whenever the front vehicle departs from a stop.
 - Always check if it is safe to proceed before driving even if the function alerts you that the front vehicle has departed.
-

i Information

The images and colors in the instrument cluster may differ depending on the cluster type or theme selected from the settings menu.

Driver Attention Warning malfunction and limitations

Driver Attention Warning malfunction

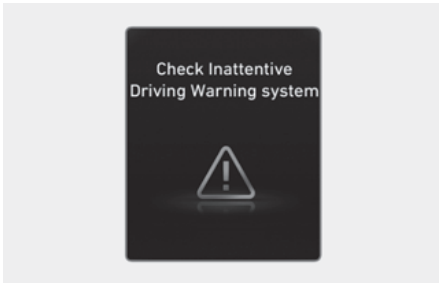

When Driver Attention Warning is not working properly, the "**Check inattentive Driving Warning system**" warning message may appear, and the (⚠) warning light may illuminate on the instrument cluster. Have the vehicle inspected by an authorized HYUNDAI dealer.

Driver Attention Warning disabled

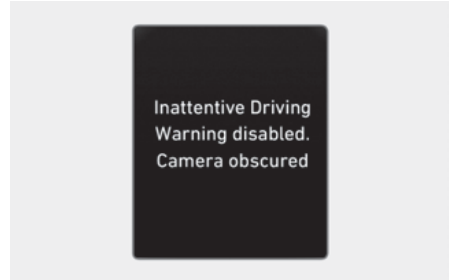

When the front windshield where the front view camera is located is covered with foreign material, such as snow or rain, it can reduce the detecting performance and temporarily limit or disable Driver Attention Warning. If this occurs, the "**Inattentive Driving Warning disabled. Camera obscured**" warning message will appear on the instrument cluster. Driver Attention Warning will operate properly when snow, rain or foreign material is removed.

If Driver Attention Warning does not operate properly after it is removed, have the vehicle inspected by an authorized HYUNDAI dealer.

WARNING

- Driver Attention Warning may not properly operate in an area (e.g. open terrain) where any objects are not detected right after turning ON the engine.
- If the engine is turned off and restarted while the camera is blocked or malfunctioned, the condition is maintained. Therefore, Driver Attention Warning may not operate properly.

Limitations of Driver Attention Warning

Driver Attention Warning may not work properly in the following situations:

- The vehicle is driven violently
- The vehicle intentionally crosses over lanes frequently
- The vehicle is controlled by Driver Assistance system, such as Lane Keeping Assist

Leading Vehicle Departure Alert feature

- When the vehicle ahead cuts in

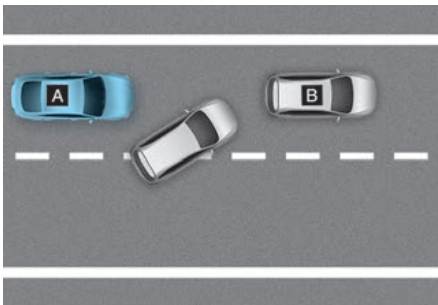
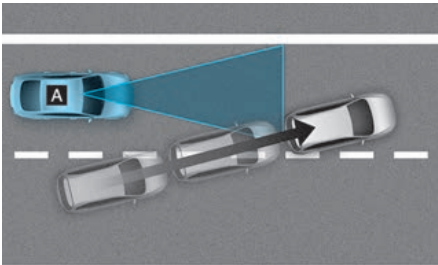

[A] Your vehicle
[B] Front vehicle

- When the vehicle ahead sharply steers

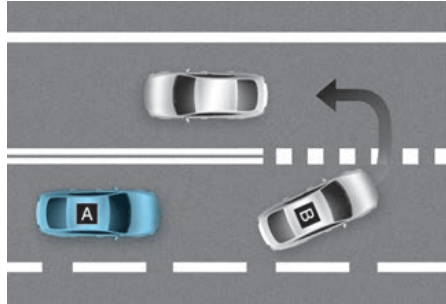

[A] Your vehicle
[B] Front vehicle

If the vehicle in front makes a sharp turn, such as to turn left or right or make a Uturn, etc., Leading Vehicle Departure Alert may not operate properly.

- When the vehicle ahead abruptly departs

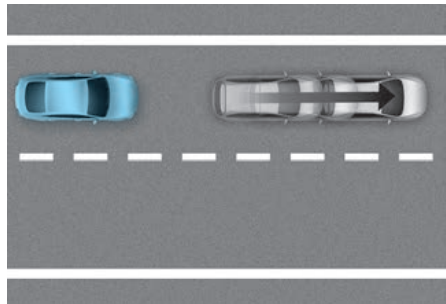

If the vehicle in front abruptly departs, Leading Vehicle Departure Alert may not operate properly.

- When a pedestrian or bicycle is between you and the vehicle ahead

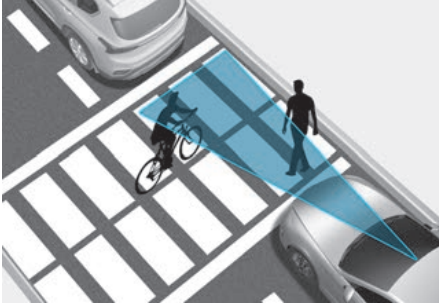

If there is a pedestrian(s) or bicycle(s) in between you and the vehicle in front, Leading Vehicle Departure Alert may not operate properly.

- When in a parking lot

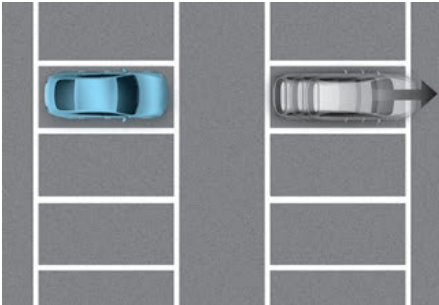

If a vehicle parked in front drives away from you, Leading Vehicle Departure Alert may alert you that the parked vehicle is driving away.

- When driving at a tollgate or intersection, etc.

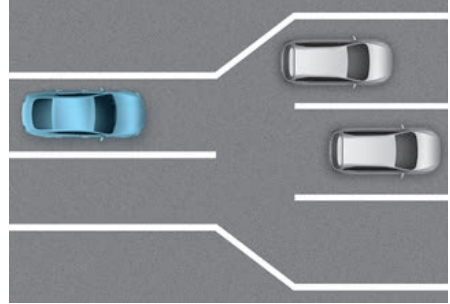

If you pass a tollgate or intersection with lots of vehicles or you drive where lanes are merged or divided frequently, Leading Vehicle Departure Alert may not operate properly.

i Information

For more information on the precautions of the front view camera, refer to the "Forward Collision Avoidance Assist (FCA) (Sensor fusion)" section in this chapter.

WARNING

Driver Attention Warning may not operate for 15 seconds right after your vehicle is started or when the front view camera is initialized.

Blind-spot View Monitor (BVM)

 If equipped

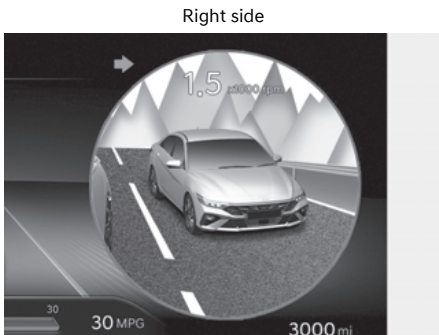
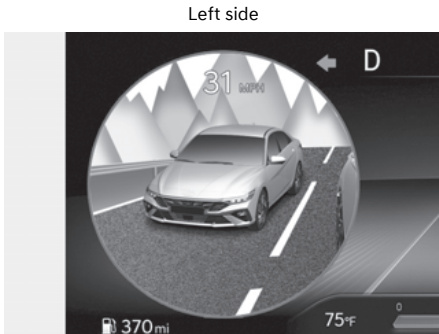

Blind-Spot View Monitor uses the wide-side view cameras to display the rear blind spot area of your vehicle on the instrument cluster when the turn signal is turned on.

Information

Blind-Spot View Monitor uses the following sensor:

- Wide-side view cameras (camera located at bottom of the mirror)

Refer to the "Driver assistance system sensors" section in this chapter for the location.

Blind-spot View Monitor settings

Blind-Spot View

With the ignition switch ON, go to **Setup > Vehicle > Driver Assistance > Driving Safety > Blind-Spot View** (for infotainment system type) from the Settings menu to turn on and off Blind-Spot View Monitor.

Blind-spot View Monitor operation

Operating conditions

The left or right side turn signal turns on, the corresponding side view camera image appears on the instrument cluster.

Off conditions

- The turn signal turns off, the image on the instrument cluster turns off.
- The hazard warning flasher is on. Blind-Spot View Monitor turns off, independent of the turn signal status.
- Other warnings on the instrument cluster may replace the side view camera image when changing lanes.

Blind-spot View Monitor malfunction

When Blind-Spot View Monitor is not working properly, have the vehicle inspected by an authorized HYUNDAI dealer.

WARNING

- Always turn your head and look to determine if there is enough distance to change lanes. The perceived distance from another vehicle shown on the instrument cluster may differ from the actual distance.
- Always keep the side view camera lenses clean. If the lens is blocked or covered, Blind-Spot View Monitor may not operate normally. Do not clean with strong chemicals containing high alkaline or volatile organic solvents (e.g. gasoline, acetone).

Cruise Control (CC)

 if equipped

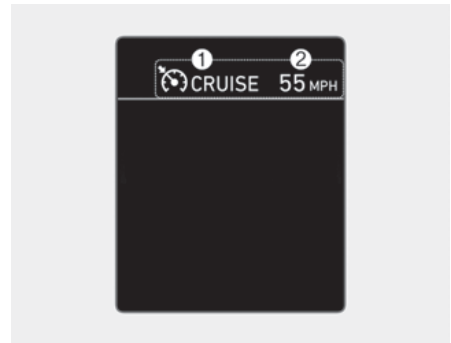

- (1) Cruise indicator light
- (2) Set speed



Cruise Control allows you to drive at speeds above 20 mph (30 km/h) without depressing the accelerator pedal.

Cruise Control operation

Setting set speed

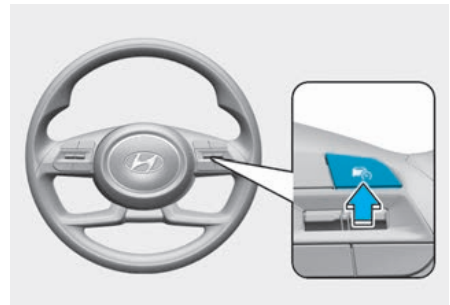
1. Accelerate to the desired speed, which must be more than 20 mph (30 km/h).



2. Press the Driving Assist () button at the desired speed. The set speed and Cruise ( CRUISE) indicator light illuminates on the instrument cluster.

3. Release the accelerator pedal.

Vehicle speed maintains the set speed even when the accelerator pedal is not depressed.

i Information

The vehicle speed may slow down or speed up while driving uphill or downhill.

Increasing set speed

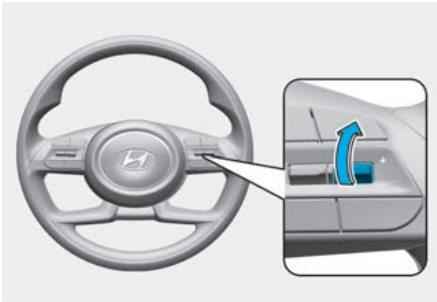

- Push the + switch up and release it immediately to increase the cruising speed by 1 mph (1 km/h).
- Push and hold the + switch up to increase to the nearest multiple of 5 mph (or multiple of 10 km/h) at first, and then increase by an additional 5 mph (10 km/h) each time.

Accelerating temporarily

If you want to accelerate temporarily when Cruise Control is on, depress the accelerator pedal.

To return to the set speed, take your foot off the accelerator pedal.

If you push the + switch up or - switch down at a higher speed, the cruising speed is set to the higher speed.

Decreasing set speed

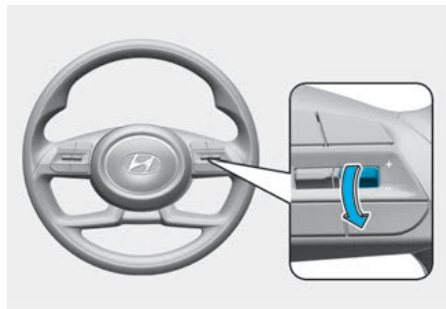

- Push the - switch down and release it immediately to decrease the cruising speed by 1 mph (1 km/h).
- Push and hold the - switch down to decrease to the nearest multiple of 5 mph (or multiple of 10 km/h) at first, and then decrease by 5 mph (10 km/h) each time.

⚠ WARNING

If you need to slow down quickly to avoid a collision, depress the brake pedal as needed.

Temporarily pausing Cruise Control

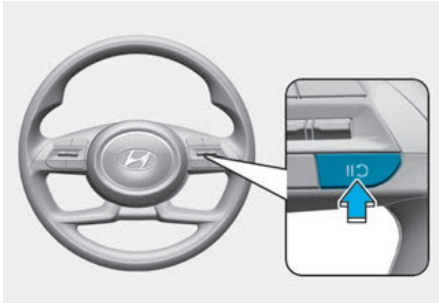

Cruise Control cancels when:

- Depressing the brake pedal
- Pressing the **||**  button
- Shifting the gear to N (Neutral)
- Decreasing vehicle speed to less than 16 mph (25 km/h)
- Operating ESC (Electronic Stability Control)
- Accelerating the vehicle speed above 118 mph (190 km/h)



The set speed turns off but the Cruise ( CRUISE) indicator light will stay on.

NOTICE

If Cruise Control cancels during a situation not listed above, have the vehicle inspected by an authorized HYUNDAI dealer.

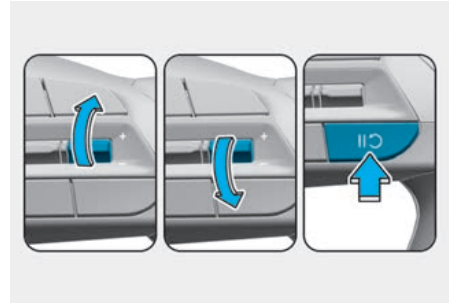
Resuming Cruise Control



- Push the +/- switch or **||**  button.
If you push the +/- switch up or down, your vehicle speed is set to the current speed on the instrument cluster.
- If you press the **||**  button, your vehicle speed resumes the previously set speed.
- Your vehicle speed must be above 20 mph (30 km/h) for the function to resume.

WARNING

Your vehicle speed may rapidly increase or decrease when you press the **||**  button.

Turning off Cruise Control

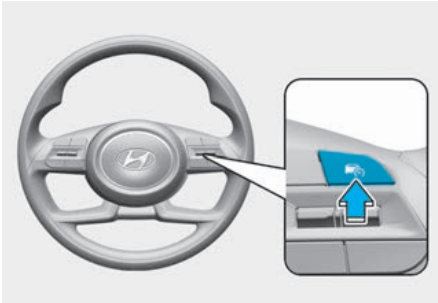

Press the Driving Assist (🚗) button to turn off Cruise Control. The Cruise (🚗 CRUISE) indicator light goes off.

Always press the Driving Assist (🚗) button to turn off Cruise Control when not in use.

i Information

If your vehicle is equipped with Manual Speed Limit Assist, press and hold the Driving Assist (🚗) button to turn off Cruise Control and turn on Manual Speed Limit Assist.

⚠ WARNING

To prevent serious injury or death:

- Keep Cruise Control off when not in use, to avoid inadvertently setting a speed. Check that the Cruise Control (🚗 CRUISE) indicator light is off.
- Always drive defensively and pay attention to the driving task.
- Set your vehicle speed to the speed limit for the road and use the appropriate unit (mph or km/h) for your country.
- Do not use Cruise Control when it may be unsafe to keep your vehicle at a constant speed including when driving:
 - in heavy traffic, or when traffic conditions make it difficult to drive at a constant speed
 - on rainy, icy, or snow-covered roads
 - on hilly or windy roads
 - with limited visibility such as fog, snow, rain, and sandstorm
- Do not shift the gear to N (Neutral) while the cruise control is activating without clutch pedal depressed.

Smart Cruise Control (SCC)

 if equipped

Basic function

Smart Cruise Control uses the front view camera and front radar to help detect a vehicle ahead and maintain the desired speed and distance between your vehicle and the vehicle ahead.

Overtaking Acceleration Assist

While Smart Cruise Control is operating, if the function judges you are attempting to overtake a vehicle in front, Smart Cruise Control accelerates your vehicle to assist you with this maneuver.

WARNING

Always monitor your vehicle speed and the distance to vehicles ahead on the road. Smart Cruise Control is not a substitute for safe driving practices, but a supplemental function only.

Information

Smart Cruise Control uses the following sensors:

- Front view camera
- Front radar

Refer to the "Driver assistance system sensors" section in this chapter for the location.

Smart Cruise Control settings

Smart Cruise Control

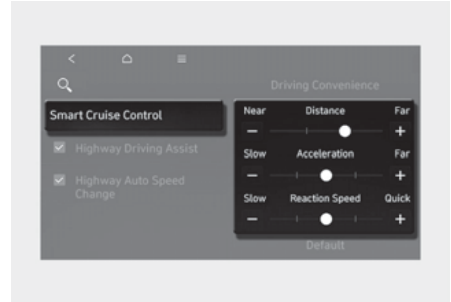

With the ignition switch ON, go to **User settings > Driver Assistance > Smart Cruise Control** from the settings menu on the instrument cluster or **Settings > Vehicle > Driver Assistance > Driving Convenience > Smart Cruise Control** in the infotainment system to change Distance, Acceleration, Reaction Speed manually.

Information

You can set the following Warning Methods:

- Warning Volume/Haptic Warning/Driving Safety Priority

For more information, refer to the "Driver assistance system settings" section in this chapter.

Smart Cruise Control operation

Operating conditions

Basic function

Smart Cruise Control operates when the following conditions are met:

- The gear is in D (Drive).
- Your vehicle speed is within the operating speed range.
 - 5-112 mph (10-180 km/h): When there is no vehicle in front
 - 0-112 mph (0-180 km/h): When there is a vehicle in front
- ESC (Electronic Stability Control) or ABS is enabled.

Smart Cruise Control does not operate when:

- The driver's door is opened.
- Engine RPM is high.
- Parking brake is applied.
- ESC (Electronic Stability Control) or ABS (Anti-Lock Braking System) is controlling your vehicle.
- Forward Collision-Avoidance Assist braking control is operating (if equipped).

i Information

If stopped behind another vehicle, you have to depress the brake pedal to turn on Smart Cruise Control.

Operating conditions for Acceleration Assist

Overtaking Acceleration Assist operates when the turn signal indicator is turned on to the left while Smart Cruise Control is operating, and the following conditions are satisfied:

- Your vehicle speed is above 40 mph (60 km/h).
- A vehicle is detected in front of your vehicle.

Overtaking Acceleration Assist does not operate when:

- The hazard warning flasher is on.
- Deceleration is needed to maintain the distance from the vehicle in front.

WARNING

- When the turn signal indicator is turned on to the left while there is a vehicle ahead, the vehicle may accelerate temporarily. Pay attention to the road conditions at all times.
 - Regardless of the driving direction in your country, Overtaking Acceleration Assist will operate when the conditions are satisfied. When using the function in countries with different driving direction, always check the road conditions at all times.
-

Turning on Smart Cruise Control

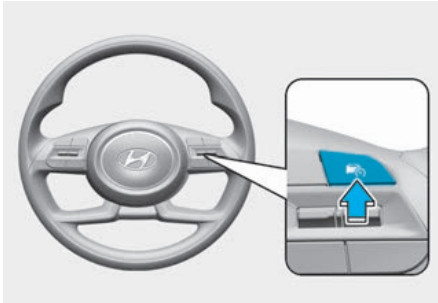

- Press the Driving Assist (Ⓜ) button. The speed is set to the current speed on the instrument cluster.
- If there is no vehicle in front of you, the set speed is maintained.
- If there is a vehicle in front of you, your vehicle speed may be adjusted to maintain the distance from the vehicle ahead.
- If the vehicle ahead accelerates and the distance between vehicles increase, your vehicle accelerates to the set speed, and then travels at a constant speed after your vehicle reaches the set distance.

i Information

- If your vehicle speed is 0-20 mph (0-30 km/h) when you press the Driving Assist (Ⓜ) button, the Smart Cruise Control speed is set to 20 mph (30 km/h).
- The Driving Assist (Ⓜ) button symbol may differ depending on your vehicle option.
- If you shift from a higher gear to a lower gear using the manual shift mode or paddle shifter, the vehicle speed may not accelerate to the set speed.

Setting vehicle distance

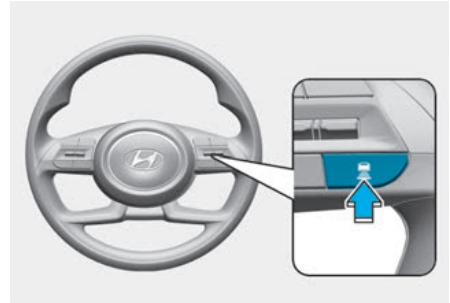

Each time the button is pressed, the vehicle distance changes as follows:

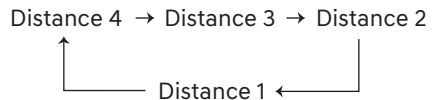

If you drive at 56 mph (90 km/h), the distance is maintained as follows:

- Distance 4 - about 172 ft. (52.5 m)
- Distance 3 - about 130 ft. (40 m)
- Distance 2 - about 106 ft. (32.5 m)
- Distance 1 - about 82 ft. (25 m)

i Information

When the engine is restarted or Smart Cruise Control is temporarily canceled, the following distance maintains the last setting.

Increasing set speed

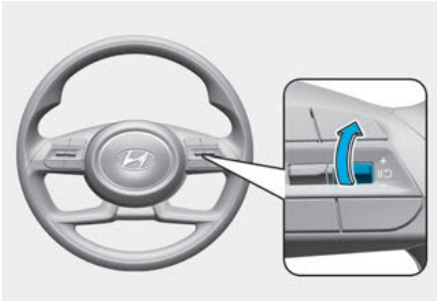

- Push the + switch up and release it immediately to increase the cruising speed by 1 mph (1 km/h).
- Push and hold the + switch up to increase to the nearest multiple of 5 mph (or multiple of 10 km/h) at first, and then increase by an additional 5 mph (10 km/h) each time.
- The vehicle speed can be set to a maximum of 112 mph (180 km/h).

⚠ WARNING

Your vehicle speed may rapidly increase when you push and hold the + switch.

Decreasing set speed

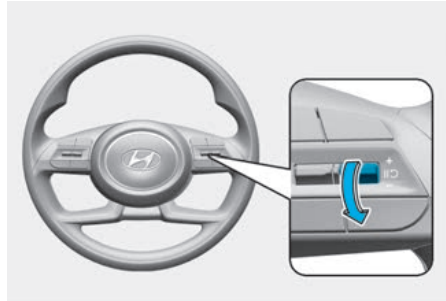

- Push the - switch down and release it immediately to decrease the cruising speed by 1 mph (1 km/h).
- Push and hold the - switch down to decrease to the nearest multiple of 5 mph (or multiple of 10 km/h) at first, and then decrease by 5 mph (10 km/h) each time.
- The vehicle speed can be set to a minimum of 20 mph (30 km/h).

⚠ WARNING

If you need to slow down quickly to avoid a collision, depress the brake pedal as needed.

Temporarily cancelling Smart Cruise Control

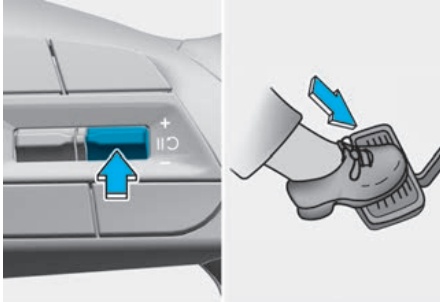

Press the **||** button or depress the brake pedal to temporarily cancel Smart Cruise Control.

Resuming Smart Cruise Control

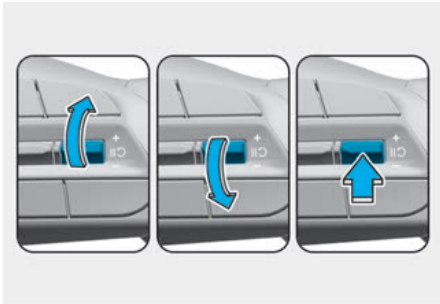

Push the +/- switch or **||** button.

If you push the +/- switch up or down, your vehicle speed is set to the current speed on the instrument cluster.

If you press the **||** button, your vehicle speed resumes to the previously set speed.

! WARNING

Your vehicle speed may rapidly increase or decrease when you press the **||** button.

Turning off Smart Cruise Control

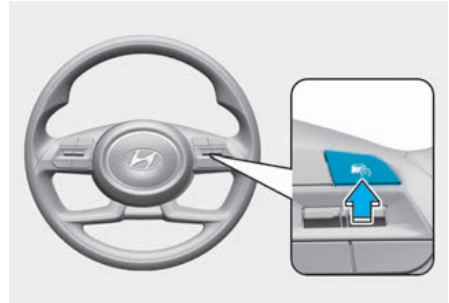

Press the Driving Assist (**DA**) button to turn off Smart Cruise Control.

i Information

If your vehicle is equipped with Manual Speed Limit Assist, press and hold the Driving Assist (**DA**) button to turn off Cruise Control and turn on Manual Speed Limit Assist.

! WARNING

Do not operate multiple buttons or switches simultaneously. Smart Cruise Control may not operate properly.

Display and control

The status of the Smart Cruise Control operation appears in Driving Assist mode on the instrument cluster. Refer to the "View modes" section in chapter 4.

When operating



- (1) Whether there is a vehicle ahead and the selected distance level appears.
- (2) Set speed appears.
- (3) Whether there is a vehicle ahead and the target vehicle distance appears.

When temporarily canceled

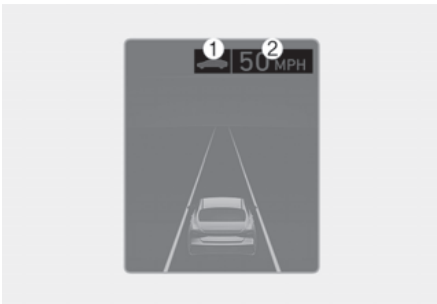

- (1) Your vehicle (grey)
- (2) Previous set speed (grey)

i Information

- The distance from the front vehicle on the instrument cluster appears according to the actual distance between your vehicle and the vehicle ahead.
- The target distance may differ depending on the vehicle speed and the set distance level. If the vehicle speed is low, even though the vehicle distance have changed, the change of the target vehicle distance may be small.
- The images and colors in the instrument cluster may differ depending on the cluster type or theme selected from the settings menu.

Accelerating temporarily



If you depress the accelerator pedal above a certain speed while Smart Cruise Control is operating, your vehicle can speed up temporarily without changing the set speed. The set speed, distance level, and target distance blink on the instrument cluster while depressing the accelerator pedal. Your vehicle speed may decrease if the accelerator pedal is not depressed far enough.

WARNING

Be careful when accelerating temporarily, because Smart Cruise Control is not controlling the speed and distance even if there is a vehicle in front of you.

Always maintain a safe distance from the vehicles ahead and adjust your vehicle speed depending on the road conditions.

Temporarily cancelling Smart Cruise Control

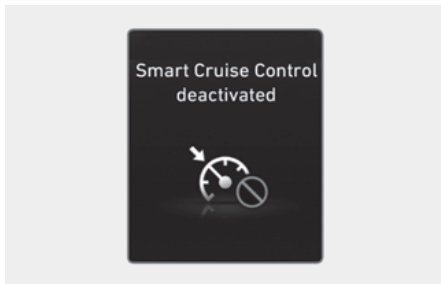

Smart Cruise Control is temporarily canceled automatically when:

- Your vehicle speed is over 120 mph (190 km/h).
- Your vehicle is stopped for a certain period of time.
- Your accelerator pedal is continuously depressed for a certain period of time.
- The conditions for the Smart Cruise Control to operate are not met.

If Smart Cruise Control is temporarily canceled automatically, the "**Smart Cruise Control deactivated**" warning message may appear on the instrument cluster, and an audible warning sounds to warn you.



If Smart Cruise Control is temporarily canceled while your vehicle is at a standstill with the function activated, the Electronic Parking Brake (EPB) may be applied.

WARNING

Always maintain a safe distance from the vehicles ahead and adjust your vehicle speed to the road conditions. When Smart Cruise Control is temporarily canceled, it is not controlling the speed and distance from the vehicle ahead.

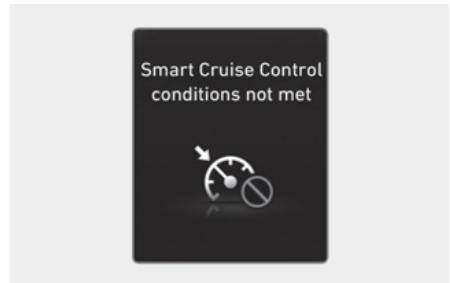
Smart Cruise Control conditions not satisfied



If the Driving Assist () button, the +/- switch, or the  button is pushed when Smart Cruise Control's operating conditions are not met, the "**Smart Cruise Control conditions not met**" message appears on the instrument cluster, and an audible warning sounds.

In traffic situation

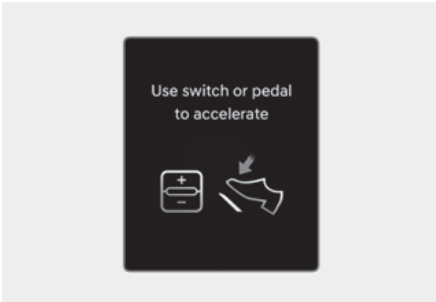

In traffic, your vehicle stops if the vehicle ahead of you stops. Also, if the vehicle ahead of you starts moving, your vehicle starts moving as well. In addition, after your vehicle has stopped and a certain amount of time has passed, the **"Use switch or pedal to accelerate"** message appears on the instrument cluster. Depress the accelerator pedal or push the +/- switch or  button to start driving.

WARNING

While the message appears on the instrument cluster, if there is no vehicle in front or the vehicle is far away from you, and the +/- switch or  button is pushed, Smart Cruise Control is automatically canceled and EPB is applied. If the accelerator pedal is depressed, EPB is not applied even though the function is canceled.

Warning road conditions ahead

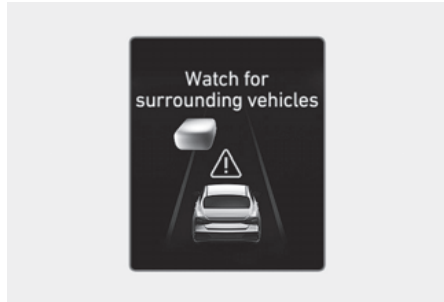

The **"Watch for surrounding vehicles"** warning message may appear on the instrument cluster, and an audible warning sounds if the vehicle in front disappears when Smart Cruise Control is maintaining the distance from the vehicle ahead while driving below a certain speed.

WARNING

Always pay attention to vehicles or objects that may suddenly appear in front of you. Always maintain a safe distance from the vehicles ahead and adjust your vehicle speed to the road conditions.

Collision Warning



While Smart Cruise Control is operating and the collision risk of the vehicle ahead is high, the "**Collision Warning**" warning message may appear on the instrument cluster, and an audible alert sounds.

WARNING

Smart Cruise Control may not warn you of a collision if:

- The distance to the vehicle ahead is close, or the speed of the vehicle ahead is faster or similar to your vehicle.
- The speed of the vehicle ahead is very slow or the vehicle is stopped.
- The accelerator pedal is depressed right after Smart Cruise Control is turned on.

Always maintain a safe distance from the vehicles ahead and adjust your vehicle speed to the road conditions.

WARNING

Smart Cruise Control is not a substitute for proper and safe driving.

To prevent serious injury or death:

- Always maintain a safe distance from the vehicles ahead and adjust your vehicle speed to the road conditions. Smart Cruise Control may not recognize unexpected and sudden situations or complex driving situations.
- Keep Smart Cruise Control off when not in use to avoid inadvertently setting the speed.
- Do not open the door or leave your vehicle when Smart Cruise Control is operating, even if your vehicle is stopped.
- Always check the vehicle speed and distance to the front vehicle that have been selected.
- Keep a safe distance depending on the road condition and vehicle speed. If the distance to the front vehicle is too close while driving at high speeds, it may cause a serious collision.
- When maintaining distance from the vehicle ahead, if the front vehicle is no longer detected, Smart Cruise Control may suddenly accelerate to the set speed.
- The vehicle speed may slow down or speed up while driving uphill or downhill.
- Always be aware of situations such as when a vehicle cuts in suddenly.
- When you are towing a trailer or another vehicle, turn off Smart Cruise Control.
- Turn off Smart Cruise Control when your vehicle is being towed.
- Smart Cruise Control may not operate normally if there is interference from strong electromagnetic waves.

- Smart Cruise Control may not detect obstacles in front and cause a collision.
- Vehicles frequently changing lanes may cause a delay or may cause Smart Cruise Control to react to a vehicle in an adjacent lane.
- When other system's warning message appears or audible warning is heard, Smart Cruise Control may not warn you.
- You may not hear the audible warning of Smart Cruise Control if the surrounding environment is too noisy.
- The vehicle manufacturer is not responsible for any traffic violation or collisions caused by you.
- Set your vehicle speed to the speed limit for the road and use the appropriate unit (mph or km/h) for your country.
- Smart Cruise Control may not operate for 15 seconds right after your vehicle is started or when the front view camera and front radar are initialized.

i Information

You may hear sounds when Smart Cruise Control is braking your vehicle. This is normal and does not indicate a malfunction.

Smart Cruise Control malfunction and limitations

Smart Cruise Control malfunction

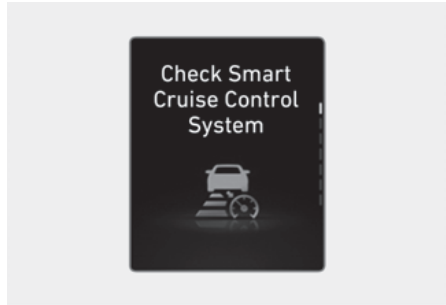

When Smart Cruise Control is not working properly, the "**Check Smart Cruise Control system**" warning message may appear, and the  warning light may illuminate on the instrument cluster. Have the vehicle inspected by an authorized HYUNDAI dealer.

Smart Cruise Control disabled

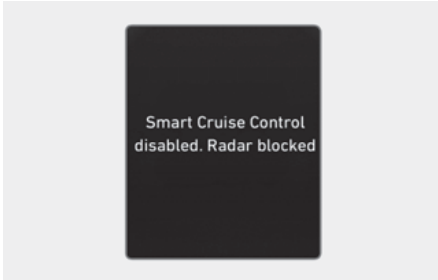

If the front radar is covered or blocked, its detecting performance is reduced, and Smart Cruise Control is temporarily limited or disabled.

The "**Smart Cruise Control disabled. Radar blocked**" warning message may appear on the instrument cluster.

If Smart Cruise Control does not operate normally after the sensor has been uncovered or unblocked, have the vehicle inspected by an authorized HYUNDAI dealer.

WARNING

- Smart Cruise Control may not operate properly even if there is no warning message or warning light on the instrument cluster.
- Smart Cruise Control may not operate properly in open areas where no objects are detected (e.g. empty parking lot) or when the detecting sensors are blocked right after turning on the engine.

Limitations of Smart Cruise Control

Smart Cruise Control may not operate normally or may operate unexpectedly if:

- The sensor or the area near the sensor is blocked, covered, or damaged.
- The temperature near the front view camera is very hot or cold.
- The camera lens is covered or blocked by windshield tint, the windshield is damaged, or a sticky material (sticker, bug, etc.) is on the glass.
- Moisture is not removed or is frozen on the windshield.
- Washer fluid is sprayed continuously, or the wiper is on.
- You are driving in heavy rain, snow, or thick fog.
- The front view camera's field of view is obstructed by glare from the sun.
- Sunlight, streetlight, or light from an oncoming vehicle is reflected on the wet road surface such as a puddle on the road.
- An object is placed on the dashboard.
- The surrounding is very bright or very dark (nighttime, tunnel, etc.).
- The brightness changes suddenly, for example when entering or exiting a tunnel.
- The brightness outside is low, and the headlights of the front vehicle are turned off or are not bright.
- A front vehicle is partially visible.
- The vehicle in front has no tail lights or tail lights are located in an unusual location.
- In low light conditions, the tail lights of the front vehicle are turned off or not bright.
- The rear of the front vehicle is small or the vehicle does not look normal, such as when your vehicle is tilted, overturned, or the side of your vehicle is visible.

- The front vehicle's ground clearance is so low or high.
- Your vehicle is being towed.
- A vehicle suddenly cuts in front.
- The bumper around the front radar has been damaged or modified, and the radar is out of position.
- A material is near that reflects very well on the front radar, such as guardrail, nearby vehicle, etc.
- The temperature near the front radar is very hot or cold.
- The vehicle in front is made of a material that does not reflect on the front radar well.
- The vehicle in front is detected late.
- The vehicle in front is suddenly blocked by an obstacle.
- The vehicle in front suddenly changes lanes or reduces the speed.
- The angle of the vehicle in front is out of the detection range.
- Your vehicle changes lanes at a low speed with a vehicle in front.
- The vehicle in front is covered with snow.
- You are on a curved road or roundabout and the vehicle in front is not detected.
- You are continuously driving in a circle.
- Your vehicle moves unstably or vibrates excessively.
- Your vehicle height is low or high due to heavy loads, abnormal tire pressure, etc.
- You are driving through steam, smoke, or shadow.
- You are driving through a tunnel or an iron bridge.
- You are driving in large, open areas where there are few vehicles or structures (e.g. desert, meadow, empty suburb).
- You are driving in a parking lot.
- You are driving through a tollbooth, construction area, unpaved road, partial paved road, uneven road, speed bumps, etc.
- You are driving through roads with railroad tracks or other embedded metal objects.
- You are driving on an inclined road or a curved road.
- You are driving on a sharply curved road.
- You are driving through a roadside with trees or streetlights.
- You are driving on a narrow road where trees or grass are overgrown.
- You are driving on a slippery surface due to snow, water puddle, ice, etc.
- You are driving in an area with strong radio waves or electrical noise interference.

- **Driving on a curved road**

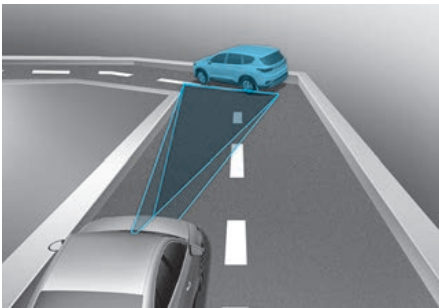
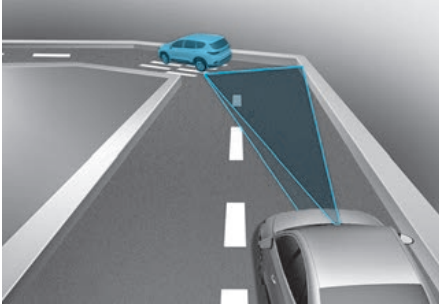

On a curved road, Smart Cruise Control may not detect a vehicle in the same lane, and may accelerate to the set speed. Your vehicle speed may be reduced if a vehicle is detected in an adjacent lane and your vehicle speed may rapidly decrease when a vehicle ahead is detected suddenly.

Select an appropriate set speed for a curved road and apply the brake pedal or accelerator pedal depending on the road and driving conditions.

- **Driving on an inclined road**

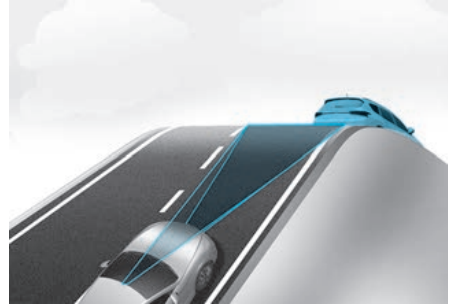

During uphill or downhill driving, Smart Cruise Control may not detect a moving vehicle in your lane, and cause your vehicle to accelerate to the set speed. Also, your vehicle speed rapidly decreases when a vehicle ahead is detected suddenly.

Select an appropriate set speed on inclines and apply the brake pedal or accelerator pedal depending on the road and driving conditions.

• Changing lanes

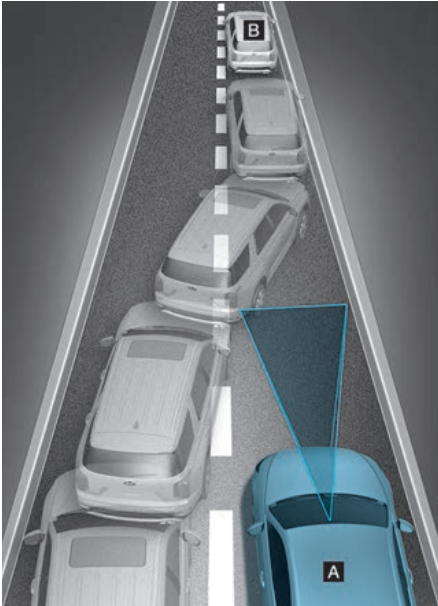

[A] Your vehicle
[B] Lane changing vehicle

When a vehicle moves into your lane from an adjacent lane, it cannot be detected by the sensor until it is in the sensor's detection range. Smart Cruise Control may not immediately detect the vehicle when your vehicle changes lanes abruptly. Brake as needed to reduce your driving speed.

• Situations when detecting are limited

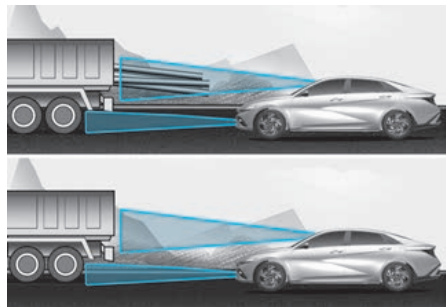
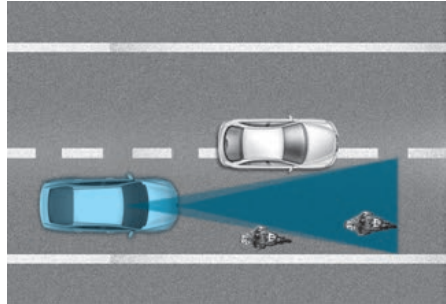

Some vehicles in your lane or in be detected by the sensor:

- Vehicles offset to one side
- Slow-moving vehicles or sudden-decelerating vehicles
- Vehicles with higher ground clearance or vehicles carrying loads that extend past the end of the vehicle
- Vehicles that have the front tilted due to heavy loads
- Oncoming vehicles
- Stopped vehicles
- Vehicles with small rear profile, such as trailers
- Narrow vehicles, such as motorcycles or bicycles
- Vehicles with low (e.g., sports car) or high (e.g. large truck, bus) ground clearance
- Animals and pedestrians

- Making sharp steering inputs when driving
- Driving on narrow or sharply curved roads

Brake as needed to reduce your driving speed.

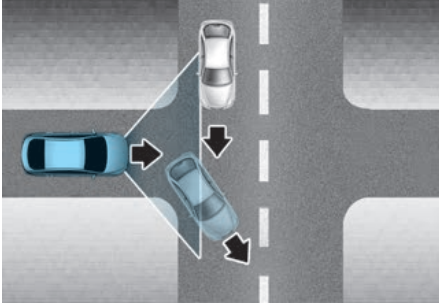

- When a vehicle ahead turns at an intersection and is no longer detected, your vehicle may accelerate.

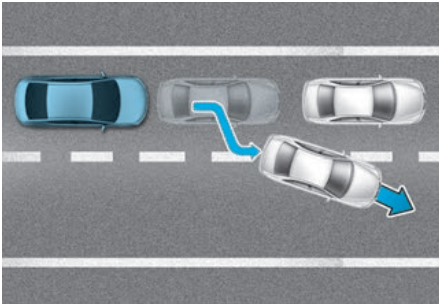

- When a vehicle in front of you merges out of the lane, Smart Cruise Control may not immediately detect a new vehicle that is now in front of your vehicle.

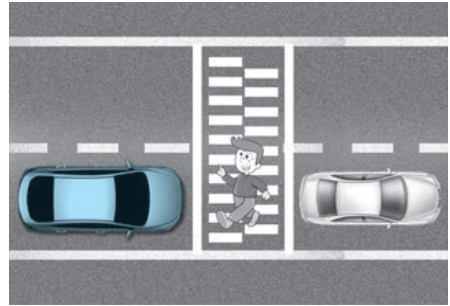

- Always look out for pedestrians when your vehicle is maintaining a distance with the vehicle ahead.

Navigation-based Smart Cruise Control (NSCC)

 If equipped

Navigation-based Smart Cruise Control helps maintain the speed depending on the road conditions when driving on highways by using information from the navigation system while Smart Cruise Control is operating.

i Information

- Navigation-based Smart Cruise Control is available only on controlled access roads.
 - Controlled access roads are roads with limited entrances and exits that allow uninterrupted high speed traffic flow.

Available highway (Controlled access road)

| | |
|--------|---|
| USA | Select Interstate Highway and U.S. (Federal) and State Highways |
| Canada | Select Provincial and Territorial Highways |

- Additional highways may be available in future navigation system updates.
- Navigation-based Smart Cruise Control does not operate on interchanges or junctions.

Highway Curve Zone Auto Slowdown

If the vehicle speed is high, Highway Curve Zone Auto Slowdown temporarily slows your vehicle in curved sections, based on the curve information in the navigation system.

Navigation-based Smart Cruise Control settings

Highway Auto Speed Change

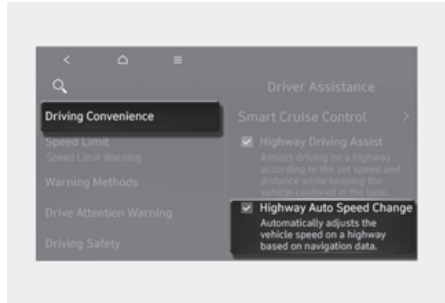

With the ignition switch ON, go to **Settings > Vehicle > Driver Assistance > Driving Convenience > Highway Auto Speed Change** from the Settings menu to turn on Navigation-based Smart Cruise Control and deselect to turn off the function.

i Information

When there is a problem with Navigation-based Smart Cruise Control, the function cannot be set from the settings menu.

Navigation-based Smart Cruise Control operation

Navigation-based Smart Cruise Control may be available when:

- Highway Auto Speed Change is selected from the settings menu.
- Smart Cruise Control is operating.
- Driving on main roads of highways (or motorways).

i Information

For more information on how to operate Smart Cruise Control, refer to the "Smart Cruise Control (SCC)" section in this chapter.

Navigation-based Smart Cruise Control display and control

The following may appear on the instrument cluster:

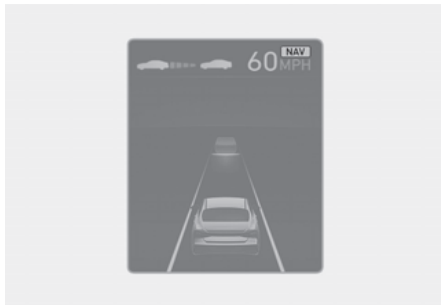

- **Navigation-based Smart Cruise Control standby**

If the operating conditions are satisfied, the green **NAV** indicator light illuminates.

- **Navigation-based Smart Cruise Control operating**

While the speed is being controlled, the green **NAV** indicator light blinks.

Temporarily canceled or interrupted by the driver

If Navigation-based Smart Cruise Control cannot control the vehicle, such as when Smart Cruise Control is temporarily canceled or the navigation system is searching for a route, the gray **NAV** indicator light illuminates.

When the driver depresses the accelerator pedal, the white **NAV** indicator light blinks.

! WARNING



The "**Drive carefully**" warning message appears if Navigation-based Smart Cruise Control is not able to slow down your vehicle.

i Information

The images and colors in the instrument cluster may differ depending on the cluster type or theme selected from the settings menu.

Highway Auto Curve Slowdown

- Depending on the curve ahead on the highway (or motorway), your vehicle decelerates, and after passing the curve, your vehicle accelerates to Smart Cruise Control's set speed.
- Vehicle deceleration time may differ depending on your vehicle speed and the degree of the curve on the road. The higher the driving speed, deceleration starts earlier.

Limitations of Navigation-based Smart Cruise Control

Navigation-based Smart Cruise Control may not operate normally if:

- The navigation system is not working properly.
- Map information is not transmitted due to an issue with the infotainment system.
- Speed limit and road information in the navigation system has not been updated.
- The map information differs from the actual road conditions because of real-time GPS data or map information error.
- The navigation system is searching for a route while driving.
- GPS signals are blocked in an area such as tunnel.
- A road is divided into two or more roads and they join again.
- You go off the route set in the navigation system.
- The route to the destination is changed or canceled by resetting the navigation system.
- Your vehicle enters a service station or rest area.
- Android Auto or Car Play is operating.

- The navigation system cannot detect the current vehicle position (e.g. elevated roads including overpass adjacent to general roads or nearby roads exist in a parallel way).
- The navigation system is updated while driving or restarts.
- The speed limits of some sections have changed according to the road situations (e.g. construction zone).
- You are driving on a road that is under facility construction.
- You are driving in lane-restricted driving situations.
- There is inclement weather, such as heavy rain or heavy snow.
- You are driving on a road with sharp curves.
- Driving on roads with intersections, roundabouts, straight entrances and exits, etc.

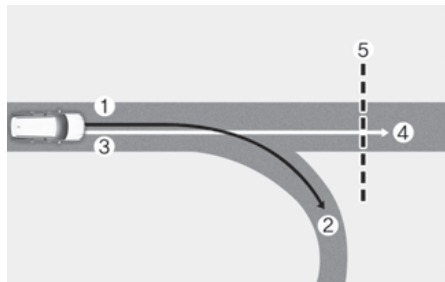

- (1) Set route
- (2) Branch line
- (3) Driving route
- (4) Main road
- (5) Curved road section

- When there is a difference between the navigation set route (branch line) and the driving route (main road), Highway Curve Zone Auto Slowdown function may not operate until the driving route is recognized as the main road.

- When the vehicle's driving route is recognized as the main road by maintaining the main road instead of the navigation set route, Highway Curve Zone Auto Slowdown function will operate. Depending on the distance to the curve and the current vehicle speed, vehicle deceleration may not be sufficient or may decelerate rapidly.

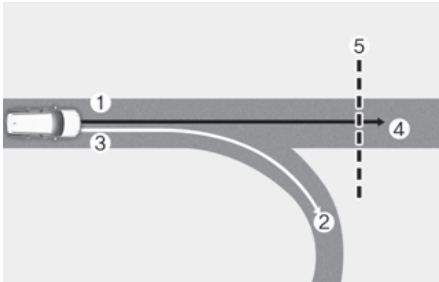

- (1) Set route
- (2) Branch line
- (3) Driving route
- (4) Main road
- (5) Curved road section

- When there is a difference between the navigation route (main road) and the driving route (branch line), Highway Curve Zone Auto Slowdown function will operate based on the curve information on the main road.
- When it is judged that you are driving out of the route by entering the highway interchange or junction, Highway Curve Zone Auto Slowdown function will not operate..

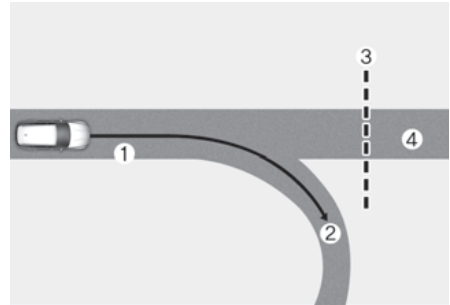

- (1) Driving route
- (2) Branch line
- (3) Curved road section
- (4) Main road

- If there is no destination set on the navigation, Highway Auto Curve Slowdown operates based on the curve information for the controlled access road in the navigation system.
- Even if you depart from the main road, Highway Curve Zone Auto Slowdown function may temporarily operate due to navigation information of the highway curve section.

WARNING

Always have your eyes on the road. It is your responsibility to avoid violating traffic laws. Navigation-based Smart Cruise Control is not a substitute for safe driving practices, but a supplemental function only.

To prevent serious injury or death:

- Always check the speed limit while driving. The navigation's speed limit information may differ from the actual speed limit on the road.
- Navigation-based Smart Cruise Control is automatically canceled when you leave the highway and enter a general road, interchange, junction, or rest area.

- Navigation-based Smart Cruise Control may not operate depending on the configuration of vehicles detected ahead on the road.
 - When you are towing a trailer or another vehicle, turn off Navigation-based Smart Cruise Control.
 - After you pass through a tollbooth on a highway, Navigation-based Smart Cruise Control operates based on the outermost lane. If you enter one of the other lanes, Navigation-based Smart Cruise Control may not operate properly.
 - Your vehicle accelerates if you depress the accelerator pedal while Navigation-based Smart Cruise Control is operating. If the accelerator pedal is not depressed far enough, your vehicle may decelerate.
 - If you accelerate and release the accelerator pedal while Navigation-based Smart Cruise Control is operating, your vehicle may not decelerate sufficiently or may rapidly decelerate.
 - If the curve is too sharp or if it is a slight curve, Navigation-based Smart Cruise Control may not operate.
-

i Information

- There may be a gap in time between the navigation system's guidance and when the Navigation-based Smart Cruise Control operation starts and ends.
 - The speed information on the instrument cluster may differ from the navigation system.
 - Even if you are driving at a speed lower than the Smart Cruise Control's set speed, acceleration may be limited by the curves ahead on the road.
 - If Navigation-based Smart Cruise Control is operating while leaving the highway and entering an interchange, junction, or rest area, the function may continue to operate for a while.
 - Deceleration by Navigation-based Smart Cruise Control may not feel sufficient due to the road conditions such as uneven road surfaces or narrow lanes.
-

Lane Following Assist (LFA)

Lane Following Assist uses the front view camera to help detect lane markings and/or vehicles on the road, and to provide steering assist to center the vehicle in the lane.

i Information

Lane Following Assist uses the following sensor:

- Front view camera

Refer to the "Driver assistance system sensors" section in this chapter for the location.

Lane Following Assist operation

Turning Lane Following Assist On/Off

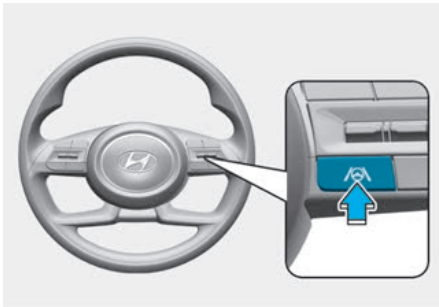

With the ignition switch ON, press the Lane Driving Assist button on the steering wheel to turn on Lane Following Assist. The white or green  indicator light illuminates on the instrument cluster. Press the button again to turn off the function.

i Information

You can set the following Warning Methods:

- Warning Volume/Driving Safety Priority

For more information, refer to the "Driver assistance system settings" section in this chapter.

Lane Following Assist



If both the lane markings and/or the vehicle ahead are detected and your vehicle speed is below 120 mph (200 km/h), Lane Following Assist helps center your vehicle in the lane by assisting with steering. The green  indicator light illuminates on the instrument cluster.

CAUTION

When the steering wheel is not assisted, the white  indicator light blinks and changes to grey.

Hands-off warning



If you take your hands off the steering wheel for several seconds, the "**Place hands on the steering wheel**" warning message may appear on the instrument cluster, and an audible warning sounds in successive stages.

First stage: Warning message

Second stage: Warning message (red steering wheel) and audible warning

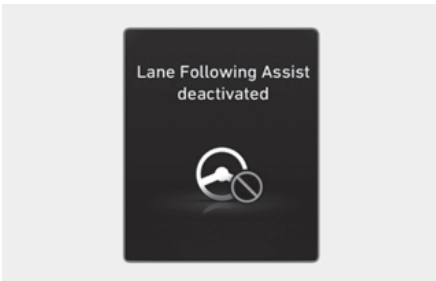

If you do not have your hands on the steering wheel after the hands-off warning, the "**Lane Following Assist deactivated**" warning message may appear and Lane Following Assist is automatically canceled.

WARNING

Always safely steer your vehicle and maintain the position of your vehicle in its lane.

To prevent serious injury or death:

- Always have your hands on the steering wheel while driving.
- Lane Following Assist may not steer if the steering wheel is held too tightly, or the steering wheel is turned too far left or right.
- If the steering wheel is held very loosely, the hands-off warning message may appear because the Lane Following Assist may not recognize that you have your hands on the steering wheel.
- The hands-off warning message may appear late or not at all depending on the road condition.
- If you attach objects to the steering wheel, the hands-off warning may not work properly.

Information

- The status of the Lane Following Assist operation appears in Driving Assist mode on the instrument cluster. Refer to the "View modes" section in chapter 4.
- When lane markings are detected, the lane lines on the instrument cluster change from gray to white.

Lane undetected



Lane detected



- The images and colors in the instrument cluster may differ depending on the cluster type or theme selected from the settings menu.
- If lane markings are not detected, steering wheel control by Lane Following Assist can be limited depending on the vehicle in front or driving condition.
- You can steer your vehicle even when steering is assisted by Lane Following Assist.
- It may require more or less force to turn the steering wheel when Lane Following Assist is providing steering assistance.

Lane Following Assist malfunction and limitations

Lane Following Assist malfunction

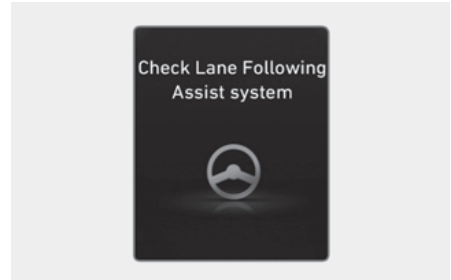

When Lane Following Assist is not working properly, the "**Check Lane Following Assist system**" message may appear, and the  warning light may illuminate on the instrument cluster. Have the vehicle inspected by an authorized HYUNDAI dealer.

Limitations of Lane Following Assist

For more information on Lane Following Assist's limitations, refer to the "Lane Keeping Assist (LKA)" section in this chapter.

i Information

For more information on "**Warnings**" when using Lane Following Assist, refer to the "Lane Keeping Assist (LKA)" section in this chapter.

Highway Driving Assist (HDA)

 If equipped

Highway Driving Assist uses the front view camera and front radar to:

- Help detect vehicles and lanes ahead.
- Help maintain the distance from the vehicle ahead and the set speed.
- Help center your vehicle in the lane while driving on the highway.

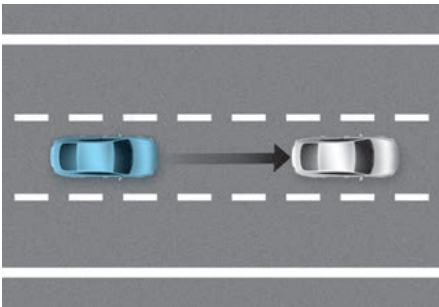

i Information

- Highway Driving Assist is available only on controlled access roads.
- Controlled access roads are roads with limited entrances and exits that allow uninterrupted high speed traffic flow.

Available highway (Controlled access road)

| | |
|--------|---|
| USA | Select Interstate Highway and U.S. (Federal) and State Highways |
| Canada | Select Provincial and Territorial Highways |

- Additional highways may be available in future navigation system updates.
- Highway Driving Assist does not operate on interchanges or junctions.

i Information

Highway Driving Assist uses the following sensors:

- Front view camera
- Front radar

Refer to the "Driver assistance system sensors" section in this chapter for the location.

Highway Driving Assist settings

Highway Driving Assist

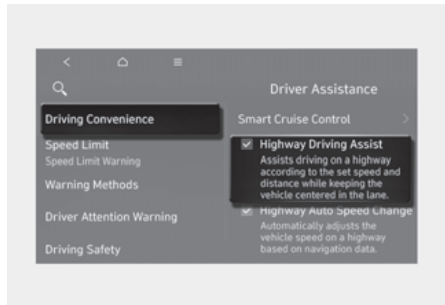

With the ignition switch ON, go to **User Settings > Driver Assistance > Driving Convenience** from the settings menu in the instrument cluster or **Settings > Vehicle > Driver Assistance > Driving Convenience** from the settings menu in the infotainment system to set whether to use each function.

- If **Highway Driving Assist** is selected, the function helps maintain distance from the vehicle ahead, maintain the set speed, and help center your vehicle in the lane while driving on the highway.

i Information

- When there is a problem with Highway Driving Assist, the function cannot be set from the Settings menu. Have the vehicle inspected by an authorized HYUNDAI dealer.
- When the engine is restarted, the function maintains the last setting.

WARNING

Only change the settings after parking your vehicle at a safe location.

i Information

You can set the following Warning Methods:

- Warning Volume/Driving Safety Priority
- For more information, refer to the "Driver assistance system settings" section in this chapter.

Highway Driving Assist operation

Highway Driving Assist display

The status of the Highway Driving Assist operation appears in Driving Assist mode on the instrument cluster. Refer to the "View modes" section in chapter 4.

Operating state



Standby state



1. Indicates if there is a vehicle ahead and the selected distance level appears.
Highway Driving Assist indicator (HDA)
 - Green HDA: Operating state
 - Grey HDA: Standby state
 - White HDA: Accelerator depressed state
2. Set speed
3. Lane Following Assist indicator
4. Whether there is a vehicle ahead and the selected headway
5. Whether the lane is detected or not

i Information

- For more information on Smart Cruise Control and Lane Following Assist, refer to the "Smart Cruise Control (SCC)" and "Lane Following Assist (LFA)" sections in this chapter.
- The images and colors in the instrument cluster may differ depending on the cluster type or theme selected from the settings menu.

Highway Driving Assist operating

Highway Driving Assist operates when:

- You have pressed the Driving Assist button after entering or driving on controlled access roads.
- Entering or driving on controlled access roads with both Lane Following Assist and Smart Cruise Control operating.

Restarting after stopping

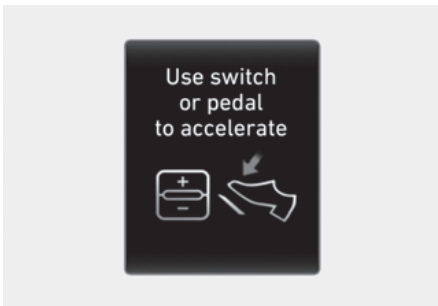

When Highway Driving Assist is operating, your vehicle stops if the vehicle ahead of you stops. Also, if the vehicle ahead of you starts moving within 30 seconds after the stop, your vehicle starts as well. If your vehicle has stopped and 30 seconds have passed, the "Use switch or pedal to accelerate" message appears on the instrument cluster. Depress the accelerator pedal or operate the +/- switch  button to accelerate.

Hands-off warning

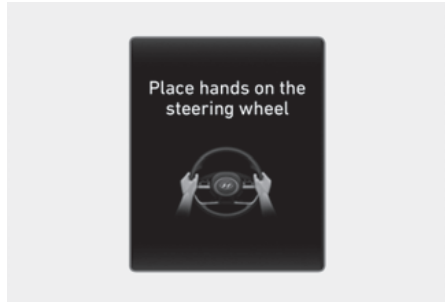

If you take your hands off the steering wheel for several seconds, the "**Place hands on the steering wheel**" warning message may appear on the instrument cluster, and an audible warning sounds in successive stages.

First stage: Warning message

Second stage: Warning message (red steering wheel) and audible warning

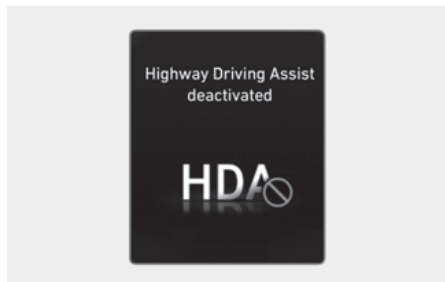

If the driver still does not have their hands on the steering wheel after the hands-off warning, the "**Highway Driving Assist deactivated**" warning message may appear and Highway Driving Assist is automatically canceled.

Highway Driving Assist malfunction and limitations

Highway Driving Assist malfunction

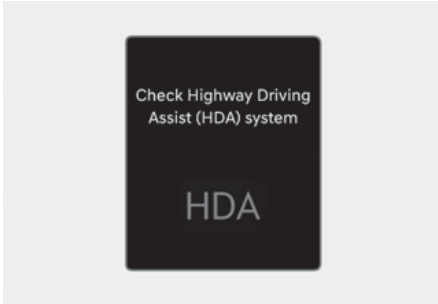

When Highway Driving Assist is not working properly, the "**Check Highway Driving Assist (HDA) system**" warning message may appear, and the  warning light may illuminate on the instrument cluster. Have the vehicle inspected by an authorized HYUNDAI dealer.

WARNING

Always check road conditions, and if necessary, take appropriate actions to drive safely. Highway Driving Assist is a supplemental function only and it is not a self driving or autonomous driving system.

To prevent serious injury or death:

- Always have your hands on the steering wheel while driving.
- Always have your eyes on the road and pay attention. It is your responsibility to avoid violating traffic laws.
- Highway Driving Assist may not be able to recognize all traffic situations and may not detect possible collision hazards. Obstacles such as vehicles, motorcycles, bicycles, pedestrians, or unspecified objects or structures (e.g. guardrails and tollbooth) may not be detected.

- Highway Driving Assist turns off automatically under the following situations:
 - You are driving on roads that Highway Driving Assist does not operate, such as rest area, intersection, junction, etc.
 - The navigation does not operate properly such as when the navigation system is updating or restarting.
- Highway Driving Assist may inadvertently operate or turn off depending on the road conditions (based on the navigation system information) and surroundings.
- Lane Following Assist may be temporarily disabled when the front view camera cannot detect lanes properly or the hands-off warning is on.
- The hands-off warning message may appear early or late depending on how the steering wheel is held or road conditions.
- You may not hear the audible warning of Highway Driving Assist if the surrounding environment is too noisy.
- When your vehicle is driven at high speeds through a curve, your vehicle may depart from your driving lane if you do not maintain control.
- When you are towing a trailer or another vehicle, turn off Highway Driving Assist.
- Highway Driving Assist may not operate right after the engine is started or when the sensors or navigation system is initialized.

Limitations of Highway Driving Assist

Highway Driving Assist may not operate normally or may not operate if:

- The map information differs from the actual road conditions because the navigation system has not been updated, or there is a real-time GPS data or map information error.
- The infotainment system is overloaded by simultaneously performing functions such as route search, video playback, voice recognition, etc.
- GPS signals are blocked in an area such as tunnel.
- You depart from the navigation route or the route to the destination is changed or canceled.
- Your vehicle enters a service station or rest area.
- Android Auto or Car Play is operating.
- The navigation system cannot detect the current vehicle position (e.g. elevated roads including overpass adjacent to general roads or nearby roads exist in a parallel way).
- A trailer or hitch mounted carrier is connected to your vehicle.

***i* Information**

For more information on the limitations of the front view camera and front radar, refer to the "Forward Collision Avoidance Assist (FCA) (Sensor fusion)" section in this chapter.

Rear View Monitor (RVM)

 if equipped

Rear View Monitor uses the wide-rear view camera to display the area behind your vehicle to assist you when parking or backing up.

***i* Information**

If display audio is applied, the description of the Rear View Monitor may differ from the owner's manual. For more information, scan the QR code in the separately supplied simple manual.

***i* Information**

Rear View Monitor uses the following sensor:

- Wide-rear view camera

Refer to the "Driver assistance system sensors" section in this chapter for the location.

Rear View Monitor settings

Camera settings

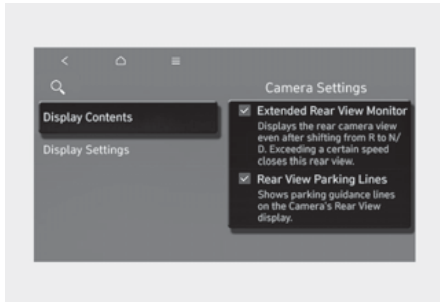

To change the settings of Rear View Monitor's Display Contents or Display Settings, press the setup icon (⚙️) on the screen while Rear View Monitor is operating, or go to **Settings > Vehicle > Driver Assistance > Parking Safety > Camera Settings** from the Settings menu in the infotainment system when the engine is on.

Extended Rear View Monitor

Keeps displaying the rear view when shifting from R (Reverse) to N (Neutral) or D (Drive). When exceeding a certain speed, the rear view stops displaying.

Rear View Parking Guide Lines

If **Rear View Parking Lines (Rear view reference lines)** is selected, the rear view parking guide lines and rear top view guide lines will be displayed at the left side of the infotainment system.

i Information

- The horizontal guideline of the Rear View Parking Guidance shows the distance of 1.6 ft. (0.5 m), 3.3 ft. (1 m) and 7.6 ft. (2.3 m) from the vehicle.
- The horizontal guideline of the Rear Top View Parking Guidance shows the distance of 1.6 ft. (0.5 m) and 4.9 ft. (1.5 m) from the vehicle.

i Information

You can set the following Warning Methods:

- Parking Safety Priority

For more information, refer to the "Driver assistance system settings" section in this chapter.

Rear View Monitor operation

Parking/View button



Press the Parking/View button (1) while the gear is in P (Park) to turn on Rear View Monitor.

Rear view with parking guidance

The rear view with parking guidance appears on the screen when parking.

Turns on if:

- You shift the gear to R (Reverse).
- You press the Parking/View button (1) while the gear is in P (Park). However, parking guidance is not displayed.

Turns off if:

- You press the Parking/View button (1) again while the gear is in P (Park) with the rear view on the screen.
- You shift the gear from R (Reverse) to P (Park).

Maintaining rear view

The rear view will maintain showing on the screen to help you when parking. However, parking guidance is not displayed.

Turns on if:

You shift the gear from R (Reverse) to N (Neutral) or D (Drive).

Turns off if:

- When vehicle speed is above 6 mph (10 km/h), the rear view will turn off.
- You shift the gear to P (Park).

Rear top view



Press the  icon.

The top view appears on the screen and the distance from the vehicle appears in the back of your vehicle.

***i* Information**

- The rear view cannot be turned off when the gear is in R (Reverse).
 - When the Rear View Monitor is turned on, the last displayed view mode appears on the screen. If the gear is in R (Reverse), the rear view appears on the screen.
-

Rear View Monitor malfunction and limitations

Rear View Monitor malfunction

When Rear View Monitor is not working properly, or the screen flickers, or the camera image does not display normally, have the vehicle inspected by an authorized HYUNDAI dealer.

Limitations of Rear View Monitor

When your vehicle is stopped for a long time in winter or when your vehicle is parked in an indoor parking lot, the exhaust fumes may temporarily blur the image.

WARNING

- Always turn your head to check blind spots. The rear view camera does not cover the entire area behind your vehicle.
- The perceived distance on the screen may differ from the actual distance.
- Always keep the rear view camera lens clean. If the lens is blocked or covered, the Rear View Monitor may not operate normally. Do not clean with strong chemicals containing high alkaline or volatile organic solvents (e.g. gasoline, acetone).

Surround View Monitor (SVM)

 if equipped

Surround View Monitor uses the wide-front view camera, wide-side view camera, and wide-rear view camera to display images around your vehicle through the infotainment system screen when parking.

- Parking Assist View provides various view modes of your vehicle's surroundings.

Information

Surround View Monitor uses the following sensors:

- Wide-front view camera
- Wide-side view cameras
- Wide-rear view camera

Refer to the "Driver assistance system sensors" section in this chapter for the location.

Surround View Monitor settings

Camera settings

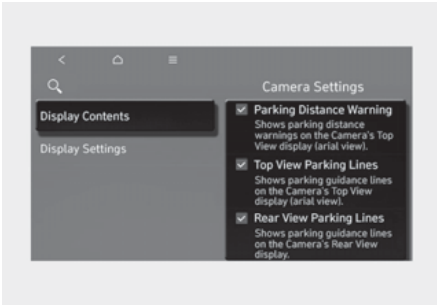

To change the settings of Surround View Monitor's Display Contents or Display Settings, press the setup icon (⚙️) on the screen while Rear View Monitor is operating, or go to **Settings > Vehicle > Driver Assistance > Parking Safety > Camera Settings** from the Settings menu in the infotainment system when the engine is on.

i Information

You can set the following Warning Methods:

- Parking Safety Priority

For more information, refer to the "Driver assistance system settings" section in this chapter.

Parking distance warning

When the Parking Distance Warning is selected, parking distance warning appears on the right side of the Surround View Monitor screen.

Top View Parking Guidance

When the **Top View Parking Lines (Top view reference lines)** is selected, parking guidance is displayed on the right side of the Surround View Monitor screen.

i Information

The horizontal guideline of the Rear Top View Parking Guidance shows the distance of 1.6 ft. (0.5 m) and 6.6 ft (2 m) from the vehicle.

Rear View Parking Guidance

If Rear View Parking Guidance is selected, the parking guideline appears on the right side of the Surround View Monitor screen when the rear view is displayed.

i Information

The horizontal guideline shows the distance of 1.6 ft. (0.5 m), 3.3 ft. (1 m) and 7.6 ft. (2.3 m).

Surround View Monitor Auto On

With the ignition switch ON, go to **Settings > Vehicle > Driver Assistance > Parking Safety > Surround View Monitor Auto On**(for infotainment system type) from the Settings menu to use the function.

If **Surround View Monitor Auto On** is selected, the front parking assist view screen appears when the Parking Distance Warning warns you while driving in D (Drive).

i Information

You can select Driving Safety Priority for Surround View Monitor from the Settings menu. For more information, refer to the "Driver assistance system settings" section in this chapter.

Surround View Monitor operation

Parking/View button



Press the Parking/View button (1) to turn on Surround View Monitor.

Front view

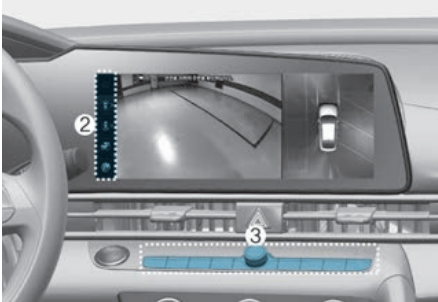

The front view appears on the screen when the gear is in N (Neutral) or D (Drive) to assist parking. The front view has top view, front view, and side view.

View modes can be selected by pressing the view buttons (2) on the Surround View Monitor screen.

Turns on if:

- The gear is in N (Neutral) or D (Drive), and your vehicle speed is 6 mph (10 km/h) or less.
- You press the Parking/View button (1) when the gear is in N (Neutral) or D (Drive) and your vehicle speed is 6 mph (10 km/h) or less.
- Surround View Monitor Auto On function is operated.
 - When **Driver Assistance > Parking Safety > Surround View Monitor Auto On** is selected from the Settings menu, the front view while parking appears.

i Information

When the front view is activated, the latest used view mode is displayed.

Turns off if:

- The gear is shifted from N (Neutral) or D (Drive) to P (Park) or R (Reverse).
- The Parking/View button (1) or the infotainment system buttons (3) is pressed.
- Vehicle speed is above 6 mph (10 km/h).

i Information

Surround View Monitor turns off if your vehicle speed is greater than 6 mph (10 km/h). Although you slow down to less than 6 mph (10 km/h) again, Surround View Monitor does not turn on again.

Rear view

The rear view appears on the screen when the gear is in R (Reverse) or P (Park) to assist parking. The rear view has top view, front view, and side view.

View modes can be selected by pressing the view buttons (2) on the Surround View Monitor screen.

Turns on if:

- The gear is shifted to R (Reverse).
- The rear view is selected by pressing the change view button (2) after pressing the Parking/View button (1), while the gear is in P (Park), N (Neutral) or D (Drive), and vehicle speed is 6 mph (10 km/h) or less.

Turns off if:

- The gear is shifted from R (Reverse) to P (Park).
- The Parking/View button (1) is pressed, while the gear is in P (Park).

***i* Information**

The rear view cannot be turned off when the gear is in R (Reverse) even if the infotainment system buttons (3) are pressed.

3D view

The 3D view shows the image around the vehicle from various angles.

You can change angles by tapping the screen. Press the 3D View button again to return to the initial angle.

Turns on if:

When the 3D view is selected by pressing the change view button (2):

- The gear is in P (Park), N (Neutral) or D (Drive) when vehicle speed is below 6 mph (10 km/h).
- The Surround View Monitor is turned on when the gear is in R (Reverse).

Turns off if:

When the gear is in P (Park), N (Neutral) or D (Drive):

- The gear is shifted to P (Park) from N (Neutral) or D (Drive).
- The Parking/View button (1) or the Infotainment system button (3) is pressed.
- Vehicle speed is above 6 mph (10 km/h).

When the gear is in R (Reverse):

- The gear is shifted to P (Park).

***i* Information**

3D view does not display guidelines.

Surround View Monitor malfunction and limitations

Surround View Monitor malfunction

When Surround View Monitor is not working properly, or the screen flickers, or the camera image does not display normally, have the vehicle inspected by an authorized HYUNDAI dealer.

Limitations of Surround View Monitor

- When your vehicle is stopped for a long time in winter or when your vehicle is parked in an indoor parking lot, the exhaust fumes may temporarily blur the image.
- The screen may not display the surround view properly and an icon may appear at the top left of the screen if:
 - The trunk is opened.
 - The driver or front passenger door is opened.
 - The side view mirror is folded.

WARNING

- Always look around your vehicle to make sure there are no objects or obstacles before driving.
- The perceived distance on the screen may differ from the actual distance.
- Surround View Monitor is designed to be used on a flat surface. When your vehicle is used on roads with different heights such as curbs and speed bumps, the image on the screen may not look correct.
- Always keep the camera lens clean. If the lens is blocked or covered, the Surround View Monitor may not operate normally. Do not clean with strong chemicals containing high alkaline or volatile organic solvents (gasoline, acetone etc.).

Rear Cross-traffic Collision-Avoidance Assist (RCCA)

 if equipped

Rear Cross-Traffic Collision-Avoidance Assist uses the rear corner radars to help detect vehicles approaching from the left or right while your vehicle is reversing, and to warn you that a collision is imminent with a warning message and an audible warning. Braking may also be assisted to avoid a collision.

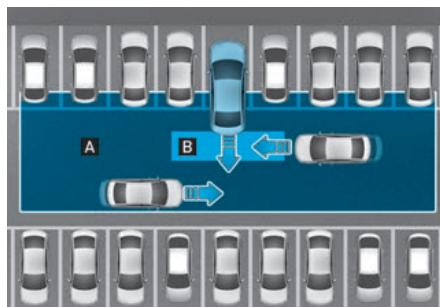

[A] Rear Cross-Traffic Collision Warning operating range
[B] Rear Cross-Traffic Collision-Avoidance Assist operating range

The time of warning may vary depending on the speed of the approaching vehicle.

Information

Rear Cross-Traffic Collision-Avoidance Assist uses the following sensor:

- Rear corner radars

Refer to the "Driver assistance system sensors" section in this chapter for the location.

Rear Cross-traffic Collision-Avoidance Assist settings

Rear Cross-Traffic Safety

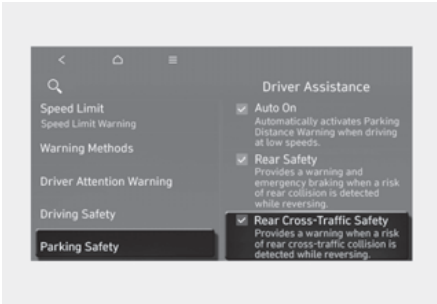

With the ignition switch ON, go to **User settings > Driver Assistance > Parking Safety > Rear Cross-Traffic Safety** from the settings menu in the instrument cluster or **Settings > Vehicle > Parking Safety > Rear Cross-Traffic Safety** from the settings menu in the infotainment system to turn on Rear Cross-Traffic Collision-Avoidance Assist and deselect to turn Rear Cross-Traffic Collision-Avoidance Assist on and off.

WARNING

When the engine is restarted, the Rear Cross-Traffic Collision-Avoidance Assist turns on. If **Off** is selected after the engine is restarted, Rear Cross-Traffic Collision-Avoidance Assist does not function until the next time your vehicle is started.

Information

Settings for **Rear Cross-Traffic Safety** include Rear Cross-Traffic Collision Warning and Rear Cross-Traffic Collision-Avoidance Assist.

Information

You can set the Warning Timing and following Warning Methods:

- Warning Volume/Haptic Warning

For more information, refer to the "Driver assistance system settings" section in this chapter.

Rear Cross-traffic Collision-Avoidance Assist operation

Rear Cross-Traffic Collision-Avoidance Assist may warn and control your vehicle depending on the collision risk level.

Collision Warning





To warn you of an approaching vehicle from the rear left or right of your vehicle, the warning light on the side view mirror may blink, a warning message may appear on the instrument cluster, and an audible warning may sound.

When Rear View Monitor is operating, a warning may appear on the infotainment system screen.

Collision warning may operate if:

- The gear is shifted to R (Reverse).
- Vehicle speed is below 5 mph (8 km/h).
- The approaching vehicle is within approximately 82 ft. (25 m) from the left and right side of your vehicle.
- The speed of the vehicle approaching from the left or right is above 3 mph (5 km/h).

i Information

- If the operating conditions are met, a warning is provided whenever your vehicle approaches from the left or right even though your vehicle speed is 0 mph (0 km/h).
- The images and colors in the instrument cluster may differ depending on the cluster type or theme selected from the settings menu.

Emergency Braking

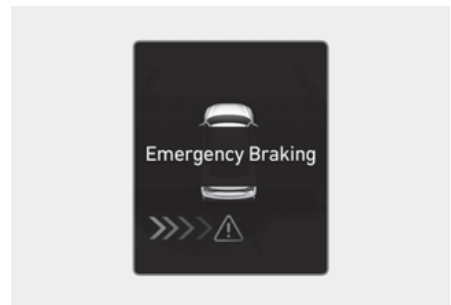
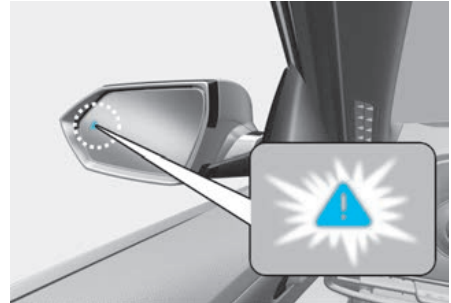

To warn you of an approaching vehicle from the rear left or right of your vehicle, the warning light on the side view mirror may blink, a warning message may appear on the instrument cluster, and an audible warning may sound.

When Rear View Monitor is operating, a warning may appear on the infotainment system screen.

If a collision is imminent, emergency braking is assisted to help prevent collision with approaching vehicles from the left and right side or your vehicle.

Emergency braking may operate if:

- The gear is shifted to R (Reverse).
- Vehicle speed is below 5 mph (8 km/h).
- The approaching vehicle is within approximately 5 ft. (1.5 m) from the left and right side of your vehicle.
- The speed of the vehicle approaching from the left and right is above 3 mph (5 km/h).

WARNING

Braking control ends when:

- The approaching vehicle is out of the detection range.
- The approaching vehicle passes behind your vehicle.
- The approaching vehicle does not continue to drive toward your vehicle.
- The approaching vehicle speed slows down.
- The driver depresses the brake pedal with sufficient power.

Stopping vehicle and ending brake control

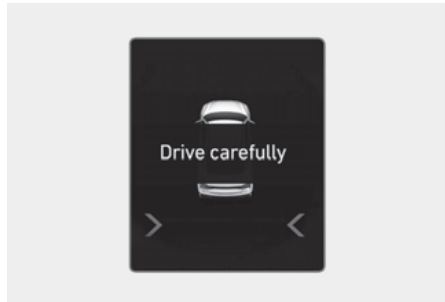

- After your vehicle is stopped following an Emergency Braking event, the "Drive carefully" warning message may appear on the instrument cluster.
- Depress the brake pedal immediately and check the surroundings.
- Braking control ends about 2 seconds after your vehicle is stopped.
- During Emergency Braking, braking control by Rear Cross-Traffic Collision-Avoidance Assist may be automatically canceled when you depress the brake pedal with sufficient force.

WARNING

Rear Cross-Traffic Collision-Avoidance Assist may not operate in all situations and cannot avoid all collisions.

To prevent serious injury or death:

- Only change the settings after parking the vehicle at a safe location.
- Always look over your shoulder for possible hazards and make sure it is safe to back up.
- When other system's warning message appears or audible warning is heard, Rear Cross-Traffic Collision-Avoidance Assist may not warn you.

- You may not hear the audible warning of Rear Cross-Traffic Collision-Avoidance Assist if the surrounding environment is too noisy.
 - During Rear Cross-Traffic Collision-Avoidance Assist operation, your vehicle may stop suddenly. Always wear your seat belt, check your occupants have their seat belts fastened and secure loose objects that may become projectiles.
 - Rear Cross-Traffic Collision-Avoidance Assist may not operate if you apply the brake pedal with sufficient force in response to the potential hazard detected by the system.
 - Even if there is an issue with Rear Cross-Traffic Collision-Avoidance Assist, the vehicle's braking system operates normally.
 - When Rear Cross-Traffic Collision-Avoidance Assist is operating, braking assist is automatically canceled when you depress the accelerator pedal with sufficient force.
 - Rear Cross-Traffic Collision-Avoidance Assist may warn you late or may not warn you depending on the road and driving conditions.
 - Control your vehicle at all times. It is your responsibility to operate your vehicle in a safe manner. Do not solely rely on the Rear Cross-Traffic Collision-Avoidance Assist to avoid a collision. Rather, maintain a safe braking distance, and if needed, reduce your vehicle speed or depress the brake pedal to reduce the driving speed or to stop your vehicle.
 - Never attempt to activate Rear Cross-Traffic Collision-Avoidance Assist by intentionally driving toward people, animals, objects, or other vehicles.
-

WARNING

Braking is not assisted and only a warning is provided when:

- The ESC (Electronic Stability Control) warning light is on.
 - ESC (Electronic Stability Control) is engaged in a different function.
-

Information

If the braking is assisted by Rear Cross-Traffic Collision-Avoidance Assist, the driver must immediately depress the brake pedal and check vehicle surroundings.

- Brake control will end when the driver depresses the brake pedal with sufficient power.
 - After shifting the gear to R (Reverse), braking control will operate once for left and right vehicle approach.
-

Rear Cross-traffic Collision-Avoidance Assist malfunction and limitations

Rear Cross-Traffic Collision-Avoidance Assist malfunction

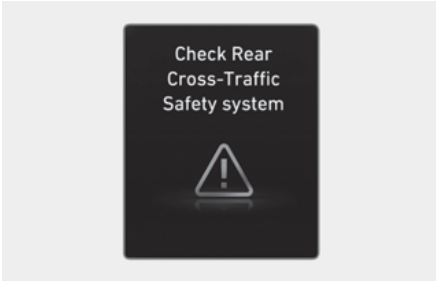

When the Rear Cross-Traffic Collision-Avoidance Assist is not working properly, the "**Check Rear Cross-Traffic Safety system**" warning message may appear, and the  warning light may illuminate on the instrument cluster. Have the vehicle inspected by an authorized HYUNDAI dealer.

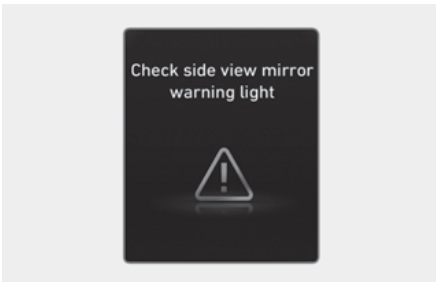

When the side view mirror warning light is not working properly, the "**Check side view mirror warning light**" warning message may appear, and the  warning light may illuminate on the instrument cluster. Have the vehicle inspected by an authorized HYUNDAI dealer.

Rear Cross-Traffic Collision-Avoidance Assist disabled

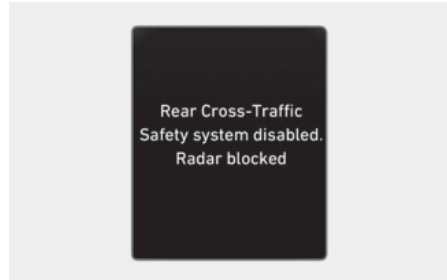

If the rear corner radar is blocked or covered, or when the rear bumper around the rear corner radar or sensor is covered by any foreign material, such as snow, rain, or dirt, or when a trailer or hitch mounted carrier is installed, the detecting performance may reduce and temporarily limit or disable Rear Cross-Traffic Collision-Avoidance Assist.

The "**Rear Cross-Traffic Safety system disabled. Radar blocked**" warning message may appear on the instrument cluster.

The function operates normally when such foreign material, trailer, or carrier is removed, and the engine is restarted.

If the function does not operate normally after anything covering or blocking the sensors is removed, have the vehicle inspected by an authorized HYUNDAI dealer.

⚠ WARNING

- Rear Cross-Traffic Collision-Avoidance Assist may not operate properly even if there is no warning message or warning light on the instrument cluster.
- Rear Cross-Traffic Collision-Avoidance Assist may not operate properly in open areas where no objects are detected (e.g. empty parking lot) or when the detecting sensors are blocked right after turning on the engine.
- Always turn off Rear Cross-Traffic Collision-Avoidance Assist when towing a trailer or using a hitch mounted carrier.

Limitations of Rear Cross-Traffic Collision-Avoidance Assist

Rear Cross-Traffic Collision-Avoidance Assist may not operate normally, or may operate unexpectedly if:

- Departing from where trees or grass are overgrown.
- Departing from where roads are wet.
- Speed of the approaching vehicle is fast or slow.

Braking may not be assisted if:

- Your vehicle severely vibrates while driving over a bumpy road, uneven road, or concrete patch.
- You are driving on a slippery surface due to snow, water puddle, ice, etc.
- The tire pressure is low or any tire is damaged.
- The braking system is adjusted differently from the factory default settings.

i Information

For more information on the limitations of the rear corner radar, refer to the "Blind-spot Collision-Avoidance Assist (BCA)" section in this chapter.

⚠ WARNING

- **Driving near a vehicle or structure**

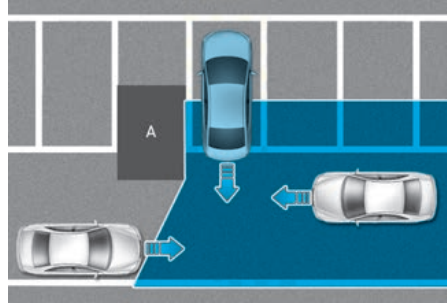

[A] Structure

Rear Cross-Traffic Collision-Avoidance Assist may be limited when driving near another vehicle or a structure, and it may not detect the vehicle approaching from the left or right. The function may not activate a warning or brake your vehicle

Always check your surroundings while backing up.

- **When your vehicle is in a complex parking environment**

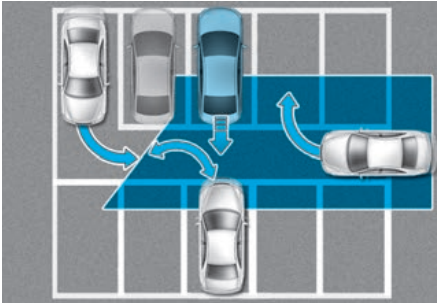

Rear Cross-Traffic Collision-Avoidance Assist may detect vehicles that are parking or pulling out near your vehicle (e.g. leaving beside your vehicle, parking or pulling out behind your vehicle, approaching your vehicle making a turn). If this occurs, the function may activate a warning and brake your vehicle even when not needed.

Always check your surroundings while backing up.

- **When your vehicle is parked diagonally**

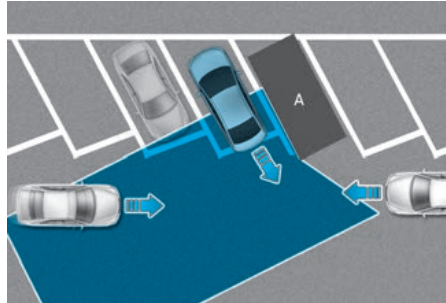

[A] Vehicle

Rear Cross-Traffic Collision-Avoidance Assist may be limited when backing up diagonally, and may not detect any vehicle approaching from the left or right. If this occurs, the function may not activate a warning or brake your vehicle.

Always check your surroundings while backing up.

- **When your vehicle is on or near a slope**

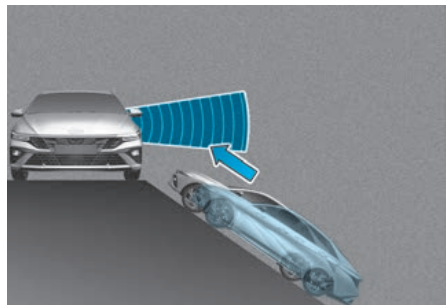

Rear Cross-Traffic Collision-Avoidance Assist may be limited when your vehicle is on an uphill or downhill slope, and may not detect any vehicle approaching from the left or right. If this occurs, the function may activate a warning and brake your vehicle even when not needed.

Always check your surroundings while backing up.

- **Pulling into the parking space where there is a structure**

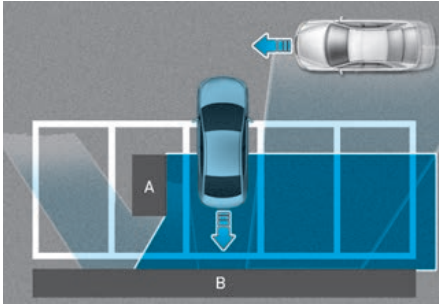

[A] Structure
[B] Wall

Rear Cross-Traffic Collision-Avoidance Assist may detect vehicles passing by in front of you when parking in reverse into a parking space with a wall or structure in the rear or side area. If this occurs, the function may activate a warning or brake your vehicle.

Always check your surroundings while backing up.

- **When your vehicle is parked rearward**

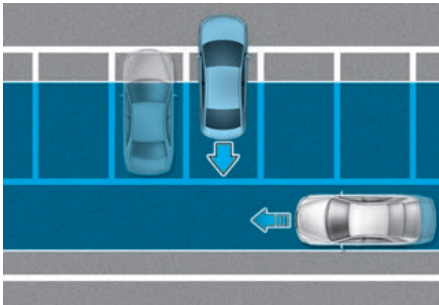

Rear Cross-Traffic Collision-Avoidance Assist may detect vehicles passing by behind you when parking in reverse into a parking space. If this occurs, the function may activate a warning and brake your vehicle even when not needed.

Always check your surroundings while backing up.

WARNING

- Rear Cross-Traffic Collision-Avoidance Assist may not operate normally if there is interference from strong electromagnetic waves.
- Rear Cross-Traffic Collision-Avoidance Assist may not operate for 3 seconds right after your vehicle is started or when the rear corner radars are initialized.

Forward/Reverse Parking Distance Warning (PDW)

 If equipped

Forward/Reverse Parking Distance Warning uses the front and rear ultrasonic sensors to detect and warns you if a person, animal, or object is within a certain distance when your vehicle is stopped or driving at low speed.

Information

Forward/Reverse Parking Distance Warning uses the following sensors:

- Front ultrasonic sensors
- Rear ultrasonic sensors

Refer to the "Driver assistance system sensors" section in this chapter for the location.

Information

You can set the following Warning Methods:

- Warning Volume

For more information, refer to the "Driver assistance system settings" section in this chapter.

Forward/Reverse Parking Distance Warning operation

Parking Safety button

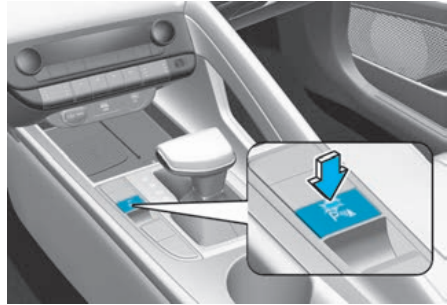

Press the Parking Safety (P) button to turn on Forward/Reverse Parking Distance Warning. Press the button again to turn off the function.

- When the gear is shift to R (Reverse), Parking Distance Warning automatically turns on (Parking Safety button indicator on).



Forward Parking Distance Warning

Forward Parking Distance Warning may operate if:

- The gear is shifted from R (Reverse) to D (Drive) with Reverse Parking Distance Warning on.
- The gear is in D (Drive) and the Parking Safety button indicator light is on.
- **Parking Distance Warning Auto On** is selected from the Settings menu and the gear is in D (Drive).

i Information

- Forward Parking Distance Warning operates only when the vehicle's forward speed is below 6 mph (10 km/h).
- Forward Parking Distance Warning is deactivated if the vehicle speed reaches above 18 mph (30 km/h). It will not reactivate although the vehicle speed drops below 6 mph (10 km/h). (Only when Parking Warning Auto On is not selected)

| Distance from object | Warning indicator when driving forward | Warning sound |
|-----------------------|---|-----------------------------|
| 24-40 in.(60-100 cm) |  | Buzzer beeps intermittently |
| 12-24 in. (30-60 cm) |  | Beeps more frequently |
| within 12 in. (30 cm) |  | Beeps continuously |

- The corresponding indicator illuminates whenever each ultrasonic sensor detects a person or object in its sensing range. Also an audible warning sounds.
- When more than two objects are detected at the same time, the closest one is warned with an audible warning.

- The shape of the indicator in the illustration may differ from the actual vehicle.



Reverse Parking Distance Warning

Reverse Parking Distance Warning may operate if:

- The gear is shifted to R (Reverse).

i Information

- Reverse Parking Distance Warning operates when the vehicle's reverse speed is below 6 mph (10 km/h).

| Distance from object | Warning indicator when driving backward | Warning sound |
|-----------------------|---|-----------------------------|
| 24-48 in.(60-120 cm) |  | Buzzer beeps intermittently |
| 12-24 in. (30-60 cm) |  | Beeps more frequently |
| within 12 in. (30 cm) |  | Beeps continuously |

- The corresponding indicator illuminates whenever each ultrasonic sensor detects a person or object in its sensing range. Also an audible warning sounds.
- When more than two objects are detected at the same time, the closest one is warned with an audible warning.

- The shape of the indicator in the illustration may differ from the actual vehicle.

Forward/Reverse Parking Distance Warning malfunction and precautions

Parking Distance Warning malfunction

After starting the engine, a beep sounds when the gear is shifted to R (Reverse) to indicate Parking Distance Warning is operating normally.

If one or more of the following occurs, check whether the ultrasonic sensor is damaged or blocked.

- The audible warning does not sound.
- The buzzer sounds intermittently.
- The "**Parking sensor error or blockage**" warning message may appear on the instrument cluster.

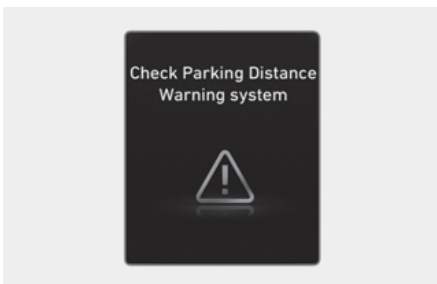

If it still does not work properly, have the vehicle inspected by an authorized HYUNDAI dealer.

Parking Distance Warning disabled

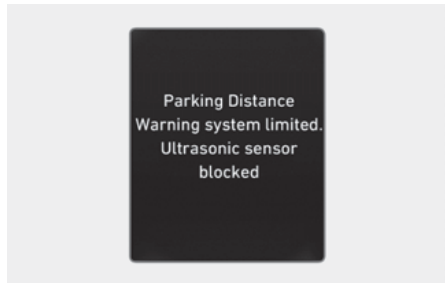

If this occurs the "**Driver assistance system limited. Ultrasonic sensor blocked**" warning message appears on the instrument cluster. Parking Distance Warning operates properly when snow, rain or foreign material is removed.

If Parking Distance Warning does not operate properly after obstruction (snow, rain, or foreign material) is removed (including trailer, carrier, etc., from the rear bumper), have the vehicle inspected by an authorized HYUNDAI dealer.

Forward/Reverse Parking Distance Warning precautions

- Parking Distance Warning may not operate properly when:
 - Moisture is frozen to the sensor
 - Sensor is covered with substance, such as snow or water (Forward/Reverse Parking Distance Warning operates properly when such substance is removed.)
 - The weather is extremely hot or cold
 - The sensor or sensor assembly is disassembled
 - The surface of the sensor is pressed hard or hit with a hard object
 - The surface of the sensor is scratched with a sharp object
 - The sensors or its surrounding area is directly sprayed with high pressure washer

- Parking Distance Warning may malfunction when:
 - Heavy rain or water spray is present
 - Water flows on the surface of the sensor
 - Affected by another vehicle's sensors
 - The sensor is covered with snow or ice
 - Driving on uneven road, gravel roads or bushes
 - Objects that generates ultrasonic waves are near the sensor
 - License plate is installed in a different spot from the original location
 - The vehicle bumper height or ultrasonic sensor installation has been modified
 - Attaching equipment or accessories next to the ultrasonic sensors
- The following objects may not be detected:
 - Sharp or slim objects, such as ropes, chains or small poles.
 - Narrow objects, such as corners of a square column
 - Objects, which tend to absorb sensor frequency, such as clothes, spongy material or snow.
 - Objects smaller than 40 in. (100 cm) in length and narrower than 6 in. (14 cm) in diameter.
 - Pedestrians, animals or objects that are very close to the ultrasonic sensors

WARNING

- Parking Distance Warning is a supplemental function. The operation of Parking Distance Warning can be affected by several factors (including environmental conditions). It is the responsibility of the driver to always check the front and rear views before and while parking.
- Your new vehicle warranty does not cover any accidents or damage to the vehicle due to the malfunction of Parking Distance Warning.
- Pay close attention when driving near objects, pedestrians, and especially children. Some objects may not be detected by the ultrasonic sensors, due to the objects distance, size or material, all of which can limit the effectiveness of the sensor.
- Parking Distance Warning does not warn you in the order of detection. It varies depending on the speed of the vehicle or the shape of a person, animal, or object.
- If the Parking Distance Warning does not operate properly, have the vehicle inspected by an authorized HYUNDAI dealer.

Reverse Parking Collision-Avoidance Assist (PCA)

 If equipped

Reverse Parking Collision-Avoidance Assist uses the wide-rear view camera and rear ultrasonic sensors to help detect pedestrians or objects when backing up. The function may warn you or assist you with braking to help reduce the possibility of a collision when backing up.

Information

Reverse Parking Collision-Avoidance Assist uses the following sensors:

- Wide-rear view camera
- Rear ultrasonic sensors

Refer to the "Driver assistance system sensors" section in this chapter for the location.

Reverse Parking Collision-Avoidance Assist settings

Parking Safety

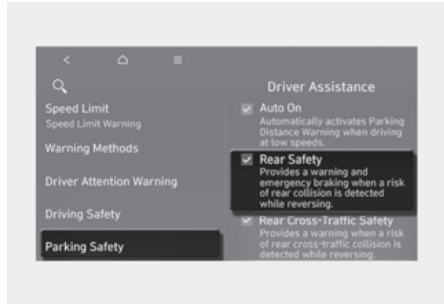

With the ignition switch ON, go to **User settings > Driver Assistance > Parking Safety** on the instrument cluster or **Settings > Vehicle > Driver Assistance > Parking Safety** on the infotainment system to set whether to use each function:

- If **Rear Safety** is selected, Parking Collision-Avoidance Assist will warn the driver and assist with braking when a collision with a pedestrian or an object is imminent from behind.

Information

You can set the following Warning Methods:

- Warning Volume/Haptic Warning

For more information, refer to the "Driver assistance system settings" section in this chapter.

Reverse Parking Collision-Avoidance Assist operation

Turning Parking Collision Avoidance Assist On/Off



Press and hold the Parking Safety (PVA) button more than 2 seconds, to turn the Parking Collision-Avoidance Assist on or off.

Operating conditions

If Reverse Parking Collision-Avoidance Assist detects a risk of collision behind the vehicle with a pedestrian or an object, Reverse Parking Collision-Avoidance Assist warns the driver with an audible warning and warning message on the cluster. If Surround View Monitor is operating, a warning appears on the infotainment.

If collision is imminent, Reverse Parking Collision-Avoidance Assist assists you with braking.

Select 'Rear Safety' from the 'Parking Safety' menu of the infotainment system. Parking Collision-Avoidance Assist is enabled when the following conditions are satisfied:

- The trunk and door are closed.
- The Electronic Parking Brake (EPB) is released.
- The gear is shifted to R (Reverse).

- Vehicle speed is below 6 mph (10 km/h). (detecting pedestrians)
- Vehicle speed is below 1.8 mph (3 km/h). (detecting objects)
- Parking Collision-Avoidance Assist components such as the rear view camera and the rear ultrasonic sensors are in normal conditions.

When Reverse Parking Collision-Avoidance Assist activates, a line appears behind the vehicle image on the instrument cluster.

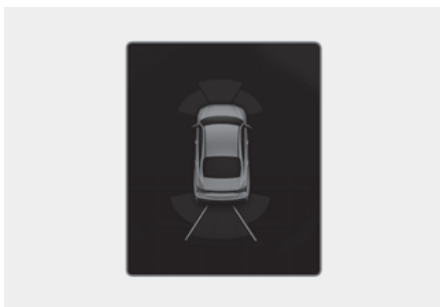

i Information

Reverse Parking Collision-Avoidance Assist operates only once after the gear is shifted to R (Reverse). To reactivate Reverse Parking Collision-Avoidance Assist, shift the gear from another gear to R (Reverse).

Off conditions

If collision is imminent, Reverse Parking Collision-Avoidance Assist will assist you with braking. Braking assist is released after 5 minutes. Immediately depress the brake pedal and check vehicle surroundings. Braking assist is also released in the following conditions when:

- The gear is shifted to P (Park) or D (Drive).
- The brake pedal is depressed with sufficient power.

***i* Information**

When Parking Collision-Avoidance Assist is activated while reversing, braking control will be released after 5 minutes and the parking brake will be engaged.

Reverse Parking Collision-Avoidance Assist malfunction and limitations

Reverse Parking Collision-Avoidance Assist malfunction

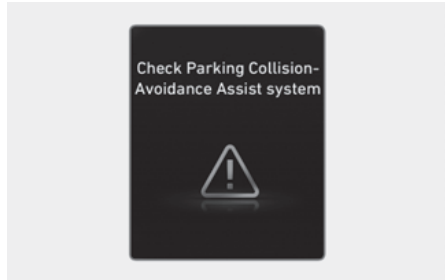

When Reverse Parking Collision-Avoidance Assist or other related functions are not working properly, the "**Check Parking Collision-Avoidance Assist system**" warning message may appear on the instrument cluster, and Reverse Parking Collision-Avoidance Assist may turn off automatically. Have the vehicle be inspected by an authorized HYUNDAI dealer.

Reverse Parking Collision-Avoidance Assist disabled

Rear view camera

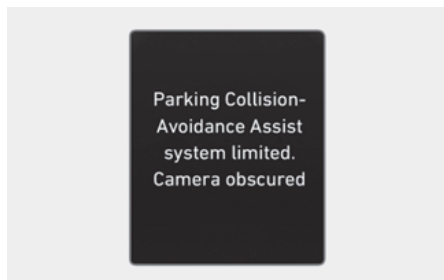

Rear ultrasonic sensor

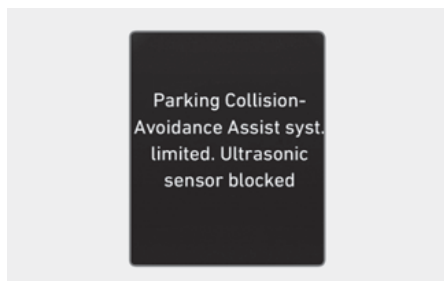

The "**Parking Collision-Avoidance Assist system limited. Camera obscured**" or "**Parking Collision-Avoidance Assist system limited. Ultrasonic sensor blocked**" warning message may appear on the instrument if:

- The rear view camera or rear ultrasonic sensor(s) is covered with foreign material, such as snow or rain, etc.
- There is inclement weather, such as heavy snow, heavy rain, etc.

If this occurs, Reverse Parking Collision-Avoidance Assist may turn off or may not operate properly. Check whether the rear view camera and rear ultrasonic sensors are clean.

Limitations of Reverse Parking Collision-Avoidance Assist

Reverse Parking Collision-Avoidance Assist may not assist braking or warn you even if there are pedestrians or objects if:

- Any non-factory equipment or accessory is installed on the rear of your vehicle.
- Your vehicle has been damaged due to an accident or other causes.
- Bumper height or rear ultrasonic sensor installation locations have been modified.
- Rear view camera or rear ultrasonic sensor(s) is damaged.
- Rear view camera or rear ultrasonic sensor(s) is covered or blocked with snow, water, or dirt.
- The surrounding is very bright or dark.
- The weather is very hot or cold.
- The wind speed is either greater than 12 mph (20 km/h) or blowing perpendicular to the rear bumper.
- Objects generating excessive noise, such as vehicle horns, loud motorcycle engines, or truck air brakes, are near your vehicle.
- An ultrasonic sensor with similar frequency is near your vehicle.
- The road is slippery or inclined.
- There is elevation difference between your vehicle and the pedestrian.
- The pedestrian blends into the background when seen from the rear view camera.
- The pedestrian is near the rear edge of your vehicle.
- The pedestrian is not standing upright.
- The pedestrian is very short or tall.
- The pedestrian is wearing clothing that easily blends into the background, making them difficult to detect.
- The pedestrian is wearing clothing that does not reflect ultrasonic waves well.

- Size, thickness, height, or shape of the object does not reflect ultrasonic waves well (e.g., pole, bush, curbs, carts, edge of a wall, etc.).
- The pedestrian or object is moving very quickly.
- The pedestrian or object is very close to the rear of your vehicle.
- There is a wall behind the pedestrian or object.
- The object is not located at the rear center of your vehicle.
- The object is not parallel to the rear bumper.
- The road is slippery or inclined.
- The pedestrian is in a state that is difficult to detect.
- You back up the vehicle immediately after shifting to R (Reverse).
- You accelerate your vehicle or drive in circles.

Reverse Parking Collision-Avoidance Assist may unnecessarily warn you or assist braking even if there are no pedestrians or objects if:

- Any non-factory equipment or accessory is installed on the rear of your vehicle.
- Your vehicle has been damaged due to an accident or other causes.
- Bumper height or rear ultrasonic sensor installation locations have been modified.
- Your vehicle height is lower or higher than normal due to heavy loads, abnormal tire pressure, etc.
- Rear view camera or rear ultrasonic sensor(s) is covered or blocked with snow, water, or dirt.
- The pattern on the road is mistaken for a pedestrian.
- There are shadows or light reflecting on the ground.

- Objects generating excessive noise, such as vehicle horns, loud motorcycle engines, or truck air brakes, are near your vehicle.
- Your vehicle is backing toward a narrow passage or parking space.
- Your vehicle is backing towards an uneven road surface, such as unpaved road, gravel, bump, gradient, etc.
- An ultrasonic sensor with similar frequency is near your vehicle.
- Pedestrians or objects are near the path of your vehicle.
- The pedestrian or object is moving very quickly.
- You accelerate your vehicle or drive in circles.

WARNING

Reverse Parking Collision-Avoidance Assist may not operate in all situations and cannot avoid all collisions.

To prevent serious injury or death:

- Always exercise extreme caution while driving. The driver is responsible for braking and safe driving.
- Always pay attention to road and traffic conditions while driving. Brake as needed to avoid collisions. Do not solely rely on Reverse Parking Collision-Avoidance Assist.
- Always look around your vehicle to make sure there are no pedestrians or objects before parking.
- The performance of Reverse Parking Collision-Avoidance Assist may differ under certain conditions. If your vehicle speed is greater than 2 mph (4 km/h), Reverse Parking Collision-Avoidance Assist provides collision avoidance assist only when pedestrians are detected.

- Reverse Parking Collision-Avoidance Assist may operate differently under certain conditions. If the vehicle moves forward and backward repeatedly, Reverse Parking Collision-Avoidance Assist may fail to assist braking or to warn the driver. Always pay attention when driving your vehicle.
- Some objects may not be detected by the rear ultrasonic sensors due to the object's distance, size, or material.
- Reverse Parking Collision-Avoidance Assist may not operate properly or may operate unnecessarily depending on the road conditions and the surroundings.
- Do not solely rely on Parking Collision-Avoidance Assist. Doing so may lead to vehicle damage or injuries.

CAUTION

- Noise may be heard when sudden braking occurs to avoid a collision.
- If any other warning sound such as the seat belt warning chime is already generated, Parking Collision-Avoidance Assist warning may not sound.
- Parking Collision-Avoidance Assist may not work properly if the bumper has been damaged, replaced or repaired.
- Parking Collision-Avoidance Assist may not operate properly if interfered by strong electromagnetic waves.
- Playing the vehicle audio system at high volume may prevent passengers from hearing Parking Collision-Avoidance Assist warning sounds.

- The brake control may not operate properly depending on the status of ESC (Electronic Stability Control).

There will only be a warning when:

- The ESC (Electronic Stability Control) warning light is on
- ESC (Electronic Stability Control) is engaged in a different function

CAUTION

Take the following precautions to maintain optimal performance of the detecting sensors:

- Always keep the wide-rear view cameras and ultrasonic sensors clean.
- Do not use any cleanser containing acid or alkaline detergents when cleaning the camera lens. Use only a mild soap or neutral detergent, and rinse thoroughly with water.
- Do not spray the wide-rear view cameras or the rear ultrasonic sensors or their surrounding area directly with a high pressure washer. It may cause the wide angle cameras or the ultrasonic sensors to malfunction.
- Do not apply objects, such as a bumper sticker or a bumper guard, near the wide angle cameras or ultrasonic sensors or apply paint to the bumper. Doing so may adversely affect the performance of Parking Collision-Avoidance Assist.
- Never disassemble or apply impact on the wide angle cameras or the ultrasonic sensors components.
- Do not apply unnecessary force on the wide-rear view cameras or the ultrasonic sensors. Reverse Parking Collision-Avoidance Assist may not operate properly if the wide angle cameras or the ultrasonic sensor(s) is forcibly moved out of proper alignment. Have the vehicle inspected by an authorized HYUNDAI dealer.

i Information

Reverse Parking Collision-Avoidance Assist can detect a pedestrian or an object when:

- A pedestrian is standing behind the vehicle.
- A large obstacle, such as a vehicle, is parked in the rear center of your vehicle.

Driver assistance system sensors

The Driver Assistance system on your vehicle uses cameras and sensors to detect potential hazards in the vicinity of your vehicle.

Cameras

Front view camera



The front view camera is mounted near the top of the windshield inside your vehicle.

Wide-front view camera

+ if equipped



The wide-front view camera is mounted on the front grill outside your vehicle.

Wide-side view camera

+ if equipped



The wide-side view cameras are mounted at bottom of the side view mirrors.

Wide-rear view camera

+ if equipped



The wide-rear view camera is mounted above the license plate holder outside your vehicle.

! WARNING

To prevent serious injury or death:

- Never disassemble the camera sensors or camera sensor assemblies.
- Only have the detecting sensor replaced or repaired by an authorized HYUNDAI dealer.
- Never install any accessories, stickers, or tint the front windshield.
- Always keep the camera dry.
- Never place any reflective objects (e.g. white paper, mirror) on the dashboard.
- Do not use any cleanser containing acid or alkaline detergents when cleaning the camera lenses. Use only a mild soap or neutral detergent, and rinse thoroughly with water.

Radars

+ if equipped

Front radar



The front radar is mounted behind the front grill.

Rear corner radar



The rear corner radars are mounted near the rear corners of your vehicle above the bumper.

WARNING

To prevent serious injury or death:

- Never disassemble the radar or radar assembly, and never apply any impact on it.
- If there is impact on or near the radar, the sensors may be damaged or not be properly aligned near the radar, even though a warning message does not appear on the instrument cluster, Driver Assistance system may not operate properly. Have the vehicle inspected by an authorized HYUNDAI dealer.
- If the radars have been replaced or repaired, have the vehicle inspected by an authorized HYUNDAI dealer.
- Use only genuine HYUNDAI parts to repair the bumper where the radar is located.
- Do not install a license plate frame or other objects such as bumper sticker, film, bumper guard, or bumper wrap near the radar.

- Driver Assistance system may not work properly if the bumper has been replaced, or the surroundings of the radar has been damaged or painted.
- If a trailer or hitch mounted carrier is attached, it may adversely affect the performance of the rear corner radar or Driver Assistance system may not operate.

Ultrasonic sensors

 If equipped

Front ultrasonic sensors



These ultrasonic sensors are mounted to the front bumper outside your vehicle.

Rear ultrasonic sensors



These ultrasonic sensors are mounted to the rear bumper outside your vehicle.

WARNING

To prevent serious injury or death:

- Always keep the ultrasonic sensors clean.
- Do not spray the ultrasonic sensors or the surrounding area directly with high pressure water.
- Do not apply objects such as bumper sticker or bumper guard, near the ultrasonic sensors or never apply paint to the bumper or other locations.
- Never disassemble or strike the ultrasonic sensors components.
- Do not modify the vehicle bumper height or ultrasonic sensor installations. Any non-factory installed equipment or accessories may also interfere with the sensor performance.
- If the ultrasonic sensors have been forcibly moved out of proper alignment or are damaged, have the vehicle inspected by an authorized HYUNDAI dealer.

Declaration of conformity

 if equipped

The radio frequency components complies:

Front radar

- For USA



FCC ID

: 2ACDX-LRR-20

This device complies with Part 15 of the FCC Rules. Operation is subject to the following two conditions:

- (1) this device may not cause harmful interference, and
- (2) this device must accept any interference received, including interference that may cause undesired operation.

CAUTION TO USERS

Changes or modifications not expressly approved by the party responsible for compliance could void the user's authority to operate the equipment.

- For Canada

Model: LRR-20
IC: 11988A-LRR20

This device complies with Industry Canada licence-exempt RSS standard(s). Operation is subject to the following two conditions:

- (1) this device may not cause interference, and
- (2) this device must accept any interference, including interference that may cause undesired operation of the device.

Le présent appareil est conforme aux CNR

d'Industrie Canada applicables aux appareils radio exempts de licence. L'exploitation est autorisée

aux deux conditions suivantes:

- (1) l'appareil ne doit pas produire de brouillage, et
- (2) l'utilisateur de l'appareil doit accepter tout brouillage radioélectrique subi, même si le brouillage est susceptible d'en compromettre le fonctionnement.

Rear corner radar

- For USA



The antenna(s) must be installed such that a minimum separation distance of at least 20 cm is maintained between the radiator (antenna) and all persons at all times. This device must not be co-located or operating in conjunction with any other antenna or transmitter.

- For Canada

This device complies with Innovation, Science and Economic Development Canada's licence-exempt RSS standard(s). Operation is subject to the following two conditions:

- (1) this device may not cause interference, and
- (2) this device must accept any interference, including interference that may cause undesired operation of the device.

Le présent appareil est conforme aux CNR d'Industrie Canada applicables aux appareils radio exempts de licence. L'exploitation est autorisée

- aux deux conditions suivantes:
- (1) l'appareil ne doit pas produire de brouillage, et
 - (2) l'utilisateur de l'appareil doit accepter tout brouillage radioélectrique subi, même si le brouillage est susceptible d'en compromettre le fonctionnement.

8. Emergency situations

| | |
|---|------|
| Hazard warning flasher | 8-2 |
| In case of an emergency while driving | 8-2 |
| If the engine stalls while driving | 8-2 |
| If the engine stalls at a crossroad or crossing..... | 8-2 |
| If you have a flat tire while driving..... | 8-3 |
| If the engine does not start..... | 8-3 |
| Jump starting..... | 8-4 |
| If the engine overheats | 8-6 |
| Tire Pressure Monitoring System (TPMS) | 8-8 |
| Check tire pressure | 8-8 |
| Tire pressure monitoring system | 8-9 |
| Low tire pressure warning light | 8-10 |
| Low tire pressure position and tire pressure telltale | 8-10 |
| TPMS malfunction indicator..... | 8-11 |
| Changing a tire with TPMS | 8-11 |
| If you have a flat tire..... | 8-13 |
| Jack and tools | 8-13 |
| Jack label..... | 8-14 |
| Changing tires | 8-15 |
| Towing..... | 8-18 |
| Towing service | 8-18 |
| Removable towing hook..... | 8-19 |
| Emergency towing..... | 8-20 |

Hazard warning flasher

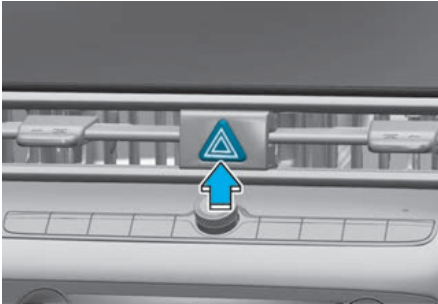

The hazard warning flashers warn other drivers to exercise extreme caution when approaching, overtaking, or passing your vehicle.

It should be used whenever making emergency repairs or when stopped near the edge of a roadway.

To turn on or off the hazard warning flasher, press the hazard warning flasher button with the ignition switch in any position. The hazard warning flasher button is located in the center fascia panel. All turn signal lights flash simultaneously.

- The hazard warning flasher operates whether your vehicle is running or not.
- The turn signals do not work when the hazard flasher is on.

In case of an emergency while driving

If the engine stalls while driving

- Reduce the speed gradually, keeping a straight line. Move cautiously off the road to a safe place.
- Turn on your hazard warning flasher.
- Try to start the engine again. If your vehicle does not start, contact an authorized HYUNDAI dealer or seek other qualified assistance.

If the engine stalls at a crossroad or crossing

If the engine stalls at a crossroad or intersection, if safe to do so, shift the gear to N (Neutral) and then push the vehicle to a safe location.

If you have a flat tire while driving

If a tire goes flat while you are driving:

- Take your foot off the accelerator pedal and let the vehicle slow down while driving straight ahead. Do not apply the brakes immediately or attempt to pull off the road because this may cause loss of vehicle control resulting in a collision. When the vehicle has slowed to such a speed that it is safe to do so, brake carefully and pull off the road. Drive off the road as far as possible and park on a firm, level ground. If you are on a divided highway, do not park in the median area between the two traffic lanes.
- When the vehicle is stopped, press the hazard warning flasher button, shift the gear to P (Park), apply the parking brake, and move the ignition switch to the LOCK/OFF position.
- Have all passengers get out of the vehicle. Make sure they all get out on the side of the vehicle that is away from traffic.
- When replacing a flat tire, follow the instructions provided later in this chapter.

If the engine does not start

- Be sure to shift the gear to N (Neutral) or P (Park). The engine starts only when the gear is in N (Neutral) or P (Park).
- Turn on the interior light. If the light dims or goes out when you operate the starter, the battery is drained.

Refer to the instructions in "Jump starting" provided in this chapter.

- Check the fuel level and add fuel if necessary.

If the vehicle still does not start, contact an authorized HYUNDAI dealer for assistance.

NOTICE

Starting the vehicle by pushing or pulling may cause the catalytic converter to overload and damage the emission control system.

Jump starting

Jump starting can be dangerous if done incorrectly. Follow the jump starting procedure in this section to avoid serious injury or damage to your vehicle. If in doubt about how to properly jump start your vehicle, have a service technician or towing service do it for you.

WARNING

To prevent **SERIOUS INJURY** or **DEATH** to you or bystanders, always follow these precautions when working near or handling the battery:



Always read and follow instructions carefully when handling a battery.



Wear eye protection designed to protect the eyes from acid splashes.



Keep all flames, sparks, or smoking materials away from the battery.



Hydrogen is always present in battery cells, is highly combustible, and may explode if ignited.



Keep batteries out of reach of children.



Batteries contain sulfuric acid that is highly corrosive. Do not allow acid to contact your eyes, skin, or clothing.

If acid gets into your eyes, flush your eyes with clean water for at least 15 minutes and get immediate medical attention. If acid gets on your skin, thoroughly wash the area. If you feel pain or a burning sensation, get medical attention immediately.

- When lifting a plastic-cased battery, excessive pressure on the case may cause battery acid to leak. Lift with a battery carrier or with your hands on opposite corners.
- Do not attempt to jump start your vehicle if your battery is frozen.
- NEVER attempt to recharge the battery when the vehicle's battery cables are connected to the battery.
- The electrical ignition system works with high voltage.
NEVER touch these components with the engine running or when the ignition switch is in the ON position.

Jump starting procedure

1. Position the vehicles close enough that the jumper cables can reach. Do not allow the vehicles to touch.
2. Avoid fans or any moving parts in the engine compartment at all times, even when the vehicles are turned off.
3. Turn off all electrical devices such as radios, lights, air conditioning, etc. Put the vehicles in P (Park) and apply the parking brake. Turn both vehicles OFF.
4. Open the engine hood.

CAUTION

Before jump starting, make sure to correctly identify the positive (+) and negative (-) terminals to avoid reverse polarity connections.

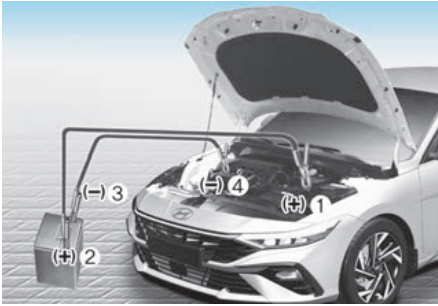

5. Connect the jumper cables in the exact sequence shown in the illustration. First connect one jumper cable to the red, positive (+) battery terminal of your vehicle (1).
6. Connect the other end of the jumper cable to the red, positive (+) battery/jumper terminal of the assisting vehicle (2).
7. Connect the second jumper cable to the black, negative (-) battery/jumper terminal of the assisting vehicle (3).
8. Connect the other end of the second jumper cable to the chassis ground of your vehicle (4).

Do not allow the jumper cables to contact anything except the correct battery or jumper terminals or the correct ground. Do not lean over the battery when making connections.

WARNING

Do not connect the jumper cable to the negative (-) jumper terminal of the discharged battery. A spark could cause the battery to explode and lead to a personal injury or vehicle damage.

9. Start the engine of the assisting vehicle and let it run at approximately 2,000 RPM for a few minutes. Then start your vehicle.

10. Keep your vehicle operating for at least 30 minutes at idle or driving to make sure your battery receives enough charge to be able to start on its own after the vehicle is shut off. A completely discharged battery may require as long as 60 minutes runtime to fully recharge. If the vehicle is run for less, the vehicle may not restart.

If your vehicle does not start after a few attempts, it probably requires service. Have your vehicle inspected by an authorized HYUNDAI dealer.

Disconnect the jumper cables in the exact reverse order you connected them:

1. Disconnect the jumper cable from the chassis ground of your vehicle (4).
2. Disconnect the other end of the jumper cable from the black, negative (-) battery/jumper terminal of the assisting vehicle (3).
3. Disconnect the second jumper cable from the red, positive (+) battery/jumper terminal of the assisting vehicle (2).
4. Disconnect the other end of the jumper cable from the red, positive (+) battery terminal of your vehicle (1).

Information



An inappropriately disposed battery may be harmful to the environment and human health. Always dispose of a used battery according to your local law(s) or regulations.

NOTICE

To prevent damage to your vehicle:

- Only use a 12 V power supply (battery or jumper system) to jump start your vehicle.
- Do not attempt to jump start your vehicle by push-starting.



WARNING

While jump starting your vehicle, avoid the positive (+) and negative (-) cables to come in contact. A spark could cause personal injury.

If the engine overheats

If your temperature gauge indicates overheating, you experience a loss of power, hear loud pinging or knocking, or the engine may be overheating. If this happens, you must:

1. Pull off the road and stop as soon as it is safe to do so.
2. Shift the gear to P (Park) and apply the parking brake. If the air conditioning is ON, turn it OFF.
3. If engine coolant is running out under the vehicle or steam is coming out from the hood, stop the engine. Do not open the hood until the coolant has stopped running or the steaming has stopped. If there is no visible loss of engine coolant and no steam, leave the engine running and check to make sure the engine cooling fan is operating. If the fan is not running, turn off the engine.



WARNING



While the engine is running, keep hands, clothing, and tools away from the moving parts such as cooling fan and drive belt to prevent serious injury.

4. Check for coolant leaking from the radiator, hoses, or under the vehicle. (If air conditioning has been used, it is normal for cold water to be draining from it when you stop.)
5. If the water pump drive belt is broken or engine coolant is leaking out, stop the engine immediately and call the nearest authorized HYUNDAI dealer for assistance.

WARNING

Never remove the radiator cap, engine coolant cap, or the drain plug while the engine and radiator are hot.

Hot coolant and steam may blow out under pressure, causing serious injury.

Turn off the engine and wait until the engine cools down. Use extreme care when removing the coolant cap. Wrap a thick towel around it, and turn it counterclockwise slowly to the first stop. Step back while the pressure is released from the cooling system.

When you are sure all the pressure has been released, press down on the cap, using a thick towel, and continue turning counterclockwise to remove it.

NOTICE

- Serious loss of coolant indicates a leak in the cooling system. Have the system inspected by an authorized HYUNDAI dealer as soon as possible.
- When the engine overheats from low engine coolant, suddenly adding engine coolant may cause cracks in the engine. To prevent damage, add engine coolant slowly in small quantities. It may require several refilling cycles to properly fill the engine cooling system. If necessary, contact an authorized HYUNDAI dealer.

6. If you cannot find the cause of the overheating, wait until the engine temperature has returned to normal. Then, if coolant has been lost, carefully add coolant to the reservoir to bring the fluid level in the reservoir up to the halfway mark.
7. Proceed with caution, keeping alert for further signs of overheating. If overheating happens again, contact an authorized HYUNDAI dealer for assistance.

Tire Pressure Monitoring System (TPMS)

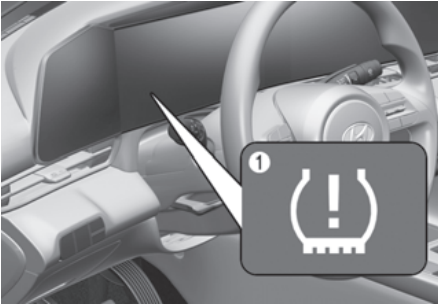

- (1) Low Tire Pressure Telltale/TPMS Malfunction Indicator
- (2) Low Tire Pressure Position Telltale and Tire Pressure Telltale (Shown on the cluster display)

Check tire pressure



- You can check the tire pressure in the Driving Assist mode in the instrument cluster.
Refer to the "View modes" section in chapter 4.
- Tire pressure appears after a few minutes of driving. If the tire pressure does not appear when the vehicle is stopped, the message, "Drive to display" appears.
- The displayed tire pressure values may differ from those measured with a tire pressure gauge.
- You can change the tire pressure unit from the Settings menu in the instrument cluster or infotainment system. Select:
 - **User Settings > Units > Tire Pressure Unit > psi, kpa, bar** (for instrument cluster)
 - **Settings > General > Units > Tire Pressure Unit > psi, kpa, bar** (for infotainment system)

Tire pressure monitoring system

WARNING

Over-inflation or under-inflation can reduce tire life, adversely affect vehicle handling, and lead to sudden tire failure that may cause loss of vehicle control resulting in an collision.

Each tire, including the spare (if provided), should be checked monthly when cold and inflated to the inflation pressure recommended by the vehicle manufacturer on the vehicle placard or tire inflation pressure label. (If your vehicle has tires of a different size than the size indicated on the vehicle placard or tire inflation pressure label, you should determine the proper tire inflation pressure for those tires.)

As an added safety feature, your vehicle has been equipped with a tire pressure monitoring system (TPMS) that illuminates a low tire pressure telltale when one or more of your tires is significantly under-inflated. Accordingly, when the low tire pressure telltale illuminates, you should stop and check your tires as soon as possible, and inflate them to the proper pressure. Driving on a significantly under-inflated tire causes the tire to overheat and can lead to tire failure.

Under-inflation also reduces fuel efficiency and tire tread life, and may affect the vehicle's handling and stopping ability.

Please note that the TPMS is not a substitute for proper tire maintenance, and it is the driver's responsibility to maintain correct tire pressure, even if under-inflation has not reached the level to trigger illumination of the TPMS low tire pressure telltale.

Your vehicle has also been equipped with a TPMS malfunction indicator to indicate when the system is not operating properly. The TPMS malfunction indicator is combined with the low tire pressure telltale. When the system detects a malfunction, the telltale flashes for about one minute and then remains continuously illuminated. This sequence continues upon subsequent vehicle start-ups as long as the malfunction exists.

When the malfunction indicator is illuminated, the system may not be able to detect or signal low tire pressure as intended. TPMS malfunctions may occur for a variety of reasons, including the installation of replacement or alternate tires or wheels on the vehicle that prevent the TPMS from functioning properly.

Always check the TPMS malfunction telltale after replacing one or more tires or wheels on your vehicle to ensure that the replacement or alternate tires and wheels allow the TPMS to continue to function properly.

NOTICE

Have the system inspected by an authorized HYUNDAI dealer if:

1. The Low Tire Pressure Telltale/TPMS Malfunction Indicator does not illuminate for 3 seconds when the ignition switch is moved to the ON position or the engine is running.
2. The TPMS Malfunction Indicator remains illuminated after blinking for about 1 minute.
3. The Low Tire Pressure Position Telltale remains illuminated.

Low tire pressure warning light



Low tire pressure position and tire pressure telltale



TPMS is not a substitute for manually checking the tire pressure with a tire gauge. Changes in temperature affect tire pressure. Refer to "Check tire pressure" in the Maintenance chapter for proper tire inflation and tire pressure measurement procedure.

When the tire pressure monitoring system warning indicators illuminate and a warning message appears on the cluster display, one or more of your tires are significantly under-inflated. The Low Tire Pressure Position Telltale indicates which tire is significantly under-inflated by illuminating the corresponding position light.

If either telltale illuminates, immediately reduce the vehicle speed, avoid hard cornering and anticipate increased stopping distances. Stop and check your tires as soon as possible. Inflate the tires to the proper pressure as indicated on the vehicle's placard or tire inflation pressure label located on the driver's side center pillar outer panel.

If you cannot reach a service station or the tire cannot hold the newly added air, replace the low pressure tire with the spare tire.

The Low Tire Pressure Telltale remains on and the TPMS Malfunction Indicator may blink for one minute and then remain illuminated (when the vehicle is driven about 10 minutes at the speed above 15.5 mph (25 km/h)) until you have the low pressure tire repaired and replaced on the vehicle.

WARNING

In winter or cold weather, the Low Tire Pressure Telltale may be illuminated if the tire pressure was adjusted to the recommended tire inflation pressure in warm weather. It does not mean your TPMS is malfunctioning because the decreased temperature leads to a proportional lowering of tire pressure.

When you drive your vehicle from a warm area to a cold area or from a cold area to a warm area, or the outside temperature is greatly higher or lower, check the tire inflation pressure and adjust the tires to the recommended tire inflation pressure.

⚠ WARNING

Low pressure damage

Significantly low tire pressure makes the vehicle unstable and may contribute to loss of vehicle control and increased braking distances.

Continued driving on low pressure tires may cause the tires to overheat and fail.

TPMS malfunction indicator

The TPMS Malfunction Indicator illuminates after it blinks for about one minute when there is a problem with the Tire Pressure Monitoring System.

Have the system inspected by an authorized HYUNDAI dealer as soon as possible.

NOTICE

If there is a malfunction with the TPMS, the individual tire pressures on the cluster display are not be available. Have the system inspected by an authorized HYUNDAI dealer as soon as possible.

NOTICE

The TPMS Malfunction Indicator may illuminate after blinking for one minute if the vehicle is near electric power supply cables or radio transmitters such as police stations, government and public offices, broadcasting stations, military installations, airports, transmitting towers, etc.

Additionally, the TPMS Malfunction Indicator may illuminate if snow chains are used or if electronic devices such as computers, chargers, remote starters, navigation, etc. are near the vehicle. This may interfere with normal operation of the TPMS.

Changing a tire with TPMS

If you have a flat tire, the Low Tire Pressure and Position telltales come on. Have the flat tire repaired by an authorized HYUNDAI dealer as soon as possible or replace the flat tire with the spare tire.

NOTICE

Do not use a puncture-repair kit not approved by HYUNDAI. Tire sealant not approved by HYUNDAI or the equivalent sealant specified for your vehicle may damage the tire pressure sensor.

The spare tire (if equipped) does not come with a tire pressure monitoring sensor. When the low pressure tire or the flat tire is replaced with the spare tire, the Low Tire Pressure Telltale remains on. Also, the TPMS Malfunction Indicator illuminates after blinking for one minute if the vehicle is driven at the speed above 15.5 mph (25 km/h) for about 10 minutes.

Once the original wheel equipped with a tire pressure monitoring sensor is reinflated to the recommended pressure and reinstalled on the vehicle, the Low Tire Pressure Telltale and TPMS Malfunction Indicator goes off within a few minutes of driving.

If the indicators do not turn off after a few minutes, visit an authorized HYUNDAI dealer.

Each wheel is equipped with a tire pressure sensor mounted inside the tire behind the valve stem (except for the spare tire). You must use TPMS specific wheels. It is recommended that you always have your tires serviced by an authorized HYUNDAI dealer.

You may not be able to identify a tire with low pressure by simply looking at it. Always use a good quality tire pressure gauge to measure. Note that a tire that is hot (from being driven) has a higher pressure measurement than a tire that is cold.

A cold tire means the vehicle has been sitting for 3 hours and driven for less than 1 mi. (1.6 km) in that 3 hour period.

Allow the tire to cool before measuring the inflation pressure. Always make sure the tire is cold before inflating to the recommended pressure.

WARNING

- The TPMS cannot alert you to severe and sudden tire damage caused by external factors such as nails or road debris.
 - If you feel any vehicle instability, immediately take your foot off the accelerator pedal, apply the brakes gradually with light force, and slowly move to a safe position off the road.
-

WARNING

Tampering with, modifying, or disabling the Tire Pressure Monitoring System (TPMS) components may interfere with the system's ability to warn the driver of low tire pressure conditions and/or TPMS malfunctions and may void the warranty.

If you have a flat tire

WARNING

Follow the instructions in this section when replacing a tire to reduce the risk of serious injury or death. Changing a tire can be dangerous.

Jack and tools

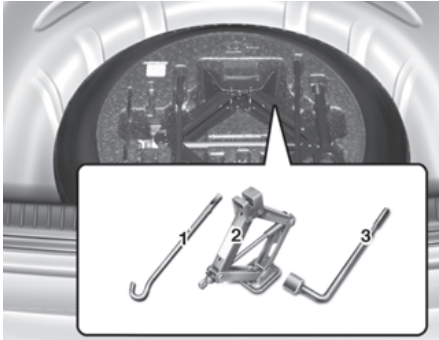

- (1) Jack handle
- (2) Jack
- (3) Wheel lug wrench

The jack and wheel lug wrench are stored in the cargo area under the luggage box cover.

The jack is provided for emergency tire changing only.



Turn the winged hold down bolt counterclockwise to remove the spare tire.

Store the spare tire in the same compartment by turning the winged hold down bolt clockwise.

To prevent the spare tire and tools from "rattling", store them in their proper locations.

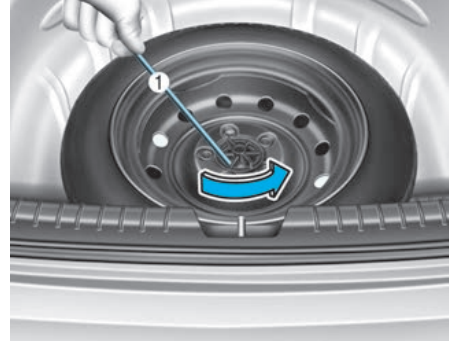

If it is hard to loosen the tire hold down wing bolt by hand, you can loosen it easily using the jack handle.

1. Put the jack handle (1) inside of the tire hold-down wing bolt.
2. Turn the tire hold-down wing bolt counterclockwise with the jack handle.

Jack label

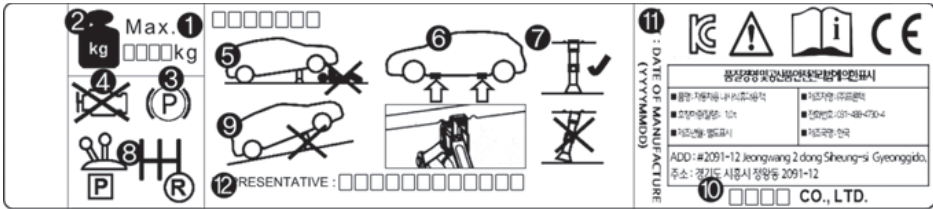

The actual jack label in the vehicle may differ from the illustration.

For more detailed specifications, refer to the label attached to the jack.

1. Model Name
2. Maximum allowable load
3. Always apply the parking brake before using a jack.
4. Always turn off the engine before using a jack.
5. Never put any portion of your body under the vehicle supported by a jack.
6. Only use the designated jacking locations on the frame.
7. When supporting the vehicle, have the base plate of the jack flat on the ground under the lifting point.
8. Shift to the P (Park) position with the gear.
9. Do not jack the vehicle on an incline. Only jack the vehicle on a firm level ground.
10. Jack manufacturer
11. Production date
12. Representative company and address

Changing tires

WARNING

Because the vehicle may slip or roll off of a jack causing serious injury or death, take the following safety precautions:

- NEVER place any portion of your body under the vehicle that is supported by a jack.
- NEVER attempt to change a tire in the lane of traffic. ALWAYS move the vehicle completely off the road on a level, firm ground away from traffic before trying to change a tire. If you cannot find a level, firm place off the road, call a towing service for assistance.
- ONLY use the jack provided with the vehicle.
- ALWAYS place the jack on the designated jacking positions on the vehicle and NEVER on the bumpers or any other part of the vehicle for jacking support.
- Do not start or run the engine while the vehicle is on the jack.
- Do not allow anyone to remain in the vehicle while it is on the jack.
- Keep children away from the road and the vehicle.

Follow these steps to change your vehicle's tire:

1. Park on a level, firm surface.
2. Shift the gear to P (Park), apply the parking brake, and move the ignition switch to the LOCK/OFF position.
3. Press the hazard warning flasher button.
4. Remove the wheel lug wrench, jack, jack handle, and spare tire from the vehicle.
5. Block both the front and rear of the tire diagonally opposite of the tire you are changing.



[A] Block

6. Loosen the wheel nuts counterclockwise one turn each in the order shown above, but do not remove any wheel nuts until the tire has been raised off of the ground.

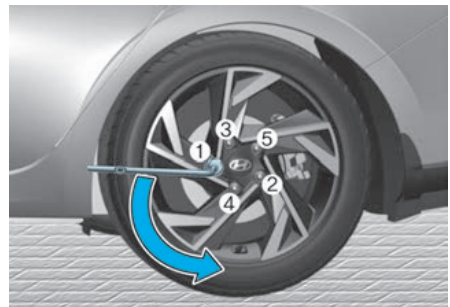

7. Place the jack at the designated jacking position under the frame closest to the tire you are changing. The jacking positions are plates welded to the frame with two notches. Never jack at any other position or part of the vehicle to prevent the vehicle slipping off of the jack or damaging the vehicle.

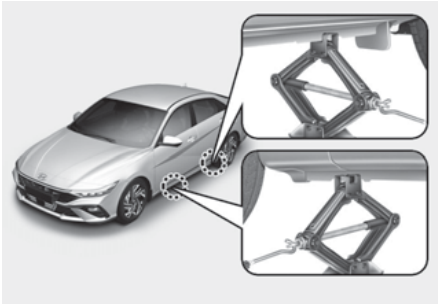

8. Insert the jack handle into the jack and turn it clockwise, raising the vehicle until the tire clears the ground. Make sure the vehicle is stable on the jack.

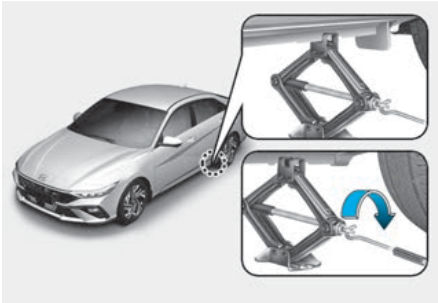

9. Loosen the wheel nuts with the wheel lug wrench and remove them with your fingers. Remove the wheel from the studs and lay it flat on the ground out of the way. Remove any dirt or debris from the studs, mounting surfaces, and spare tire.

WARNING

Because the wheels may have sharp edges, handle them carefully to avoid possible severe injury. Before putting the wheel into place, make sure that there is nothing on the hub or wheel (such as mud, tar, gravel, etc.) that interferes with the wheel from fitting solidly against the hub.

If there is, remove it. If there is not good contact on the mounting surface between the wheel and hub, the wheel nuts may come loose and cause the loss of a wheel. Loss of a wheel may result in loss of control of the vehicle. This may cause serious injury or death.

10. Install the spare tire onto the studs of the hub.
11. Tighten the wheel nuts with your fingers onto the studs with the smaller end of the wheel nuts closest to the wheel.
12. Lower the vehicle to the ground by turning the jack handle counterclockwise.



13. Use the wheel lug wrench to tighten the wheel nuts in the order shown. Double-check each wheel nuts until they are tight. After changing tires, have an authorized HYUNDAI dealer tighten the wheel nuts to their proper torque as soon as possible. Tighten the wheel nuts to 79-94 lbf.ft (11-13 kgf.m).

Check the tire pressure after installing the compact spare tire. The compact spare tire should be inflated to 60 psi (420 kPa). If you have a tire gauge, check the spare tire pressure (refer to the "Tires and Wheels" section in chapter 10 for tire pressure instructions.). If the spare tire pressure is lower or higher than the recommended, drive slowly to the nearest service station and adjust to the recommended pressure.

Always reinstall the valve cap after checking or adjusting the tire pressure. If the cap is not replaced, air may leak from the tire. If you lose a valve cap, buy another and install it as soon as possible. After changing tires, secure the flat tire and return the jack and tools to their proper storage locations.

NOTICE

Check the tire pressure as soon as possible after installing a spare tire. Adjust it to the recommended pressure.

⚠ WARNING

- Your vehicle has metric threads on the studs and wheel nuts. During tire changing, make sure that the nuts that were removed are reinstalled. If you have to replace your wheel nuts, make sure they have metric threads to avoid damaging the studs and make sure the wheel is properly secured to the hub. Contact an authorized HYUNDAI dealer for assistance.
- If the wheel studs are damaged, they may lose their ability to retain the wheel. This may cause loss of the wheel and a collision resulting in serious injuries.

If any of the equipment such as jack, wheel nuts, studs, or other equipment is damaged or in poor condition, do not attempt to change the tire and call for assistance.

Use of compact spare tires

Compact spare tires are designed for emergency use only. Drive carefully on the compact spare tire and always follow the safety precautions.

⚠ WARNING

To prevent compact spare tire failure and loss of control possibly resulting in a collision:

- Use the compact spare tire only in an emergency.
- NEVER operate your vehicle over 50 mph (80 km/h).
- Do not exceed the vehicle's maximum load rating or the load carrying capacity shown on the sidewall of the compact spare tire.
- Do not use the compact spare tire continuously. Repair or replace the original tire as soon as possible to avoid failure of the compact spare tire.

When driving on the compact spare tire mounted to your vehicle:

- Do not take this vehicle through an automatic car wash after the compact spare tire has been installed.
- Do not use the compact spare tire on any other vehicle because this tire has been designed especially for your vehicle.
- The compact spare tire's tread life is shorter than a regular tire. Inspect your compact spare tire regularly and replace worn compact spare tires with the same size and design, mounted on the same wheel.
- Do not use more than one compact spare tire at a time.
- Do not tow a trailer while the compact spare tire is installed.

i Information

When the original tire and wheel are repaired and reinstalled on the vehicle, the wheel nut torque must be set correctly. The correct wheel nut tightening torque is 79-94 lbf.ft (11-13 kgf.m).

NOTICE

To prevent damaging the compact spare tire and your vehicle:

- Drive slowly enough for the road conditions to avoid all hazards, such as a potholes or debris.
- Avoid driving over obstacles. The compact spare tire diameter is smaller than the diameter of a conventional tire and reduces the ground clearance about 1 in. (25 mm).
- Do not use tire chains on the compact spare tire. Because of the smaller size, a tire chain will not fit properly.
- Do not use the compact spare tire on any other wheels, nor should standard tires, snow tires, wheel covers or trim rings be used with the compact spare wheel.
- Do not suddenly accelerate or decelerate (0 <-> 25 mph (0 <-> 40 km/h)) in any driving mode. It may cause leakage of transfer oil.

Towing

Towing service

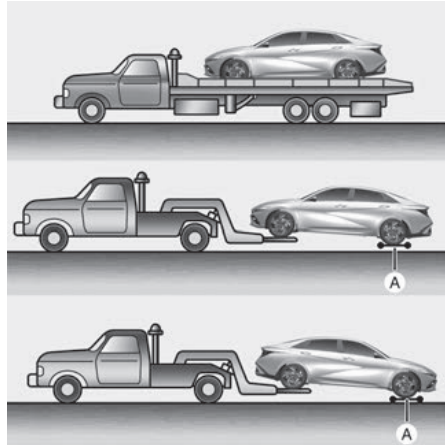

[A] Dollies

If towing is necessary, contact an authorized HYUNDAI dealer or a commercial tow-truck service.

2WD vehicles can be towed with the rear wheels on the ground (without dollies) and the front wheels off the ground. The use of wheel dollies or flatbed is recommended. If any of the loaded wheels or suspension components are damaged or the vehicle is towed with the front wheels on the ground, use a towing dolly under the front wheels.

NOTICE

To prevent damage when towing:

- Do not lift using the trailer hitch or body and chassis parts.
- Do not tow the vehicle with the front wheels on the ground.

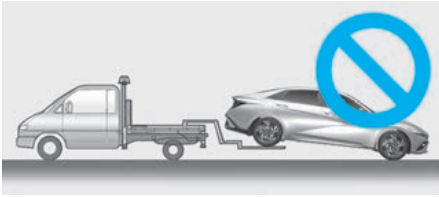

- Do not tow vehicles with sling-type equipment. Only use wheel lift or flatbed equipment.



- Your vehicle is not designed to be dinghy towed (with 4 wheels on the ground) behind a motor home. To avoid serious damage to your vehicle, do not tow your vehicle with four wheels on the ground.



When towing your vehicle without wheel dollies:

1. Turn off the engine.
2. Place the ignition switch to the LOCK/OFF position.
3. Change the gear to N (Neutral) while depressing the brake pedal. Place the ignition switch to the LOCK/OFF position.
4. Place the ignition switch to the LOCK/OFF position.
5. Release the parking brake (hand type).

WARNING

If your vehicle is equipped with a rollover sensor, place the ignition switch in the LOCK/OFF or ACC position when the vehicle is being towed. The side impact and curtain air bag may deploy if the sensor detects the situation as a rollover.

NOTICE

Always shift the gear to N (Neutral) to prevent damage to the transmission before towing.

Removable towing hook

1. Open the trunk, and remove the towing hook from the tool case.



2. Remove the hole cover by pressing the lower part of the cover on the bumper.

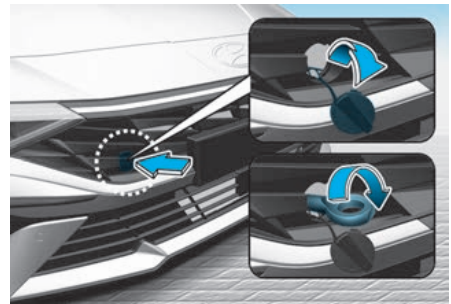

3. Install the towing hook by turning it clockwise into the hole until it is fully secured.

4. Remove the towing hook and install the cover after use.

Emergency towing

Front

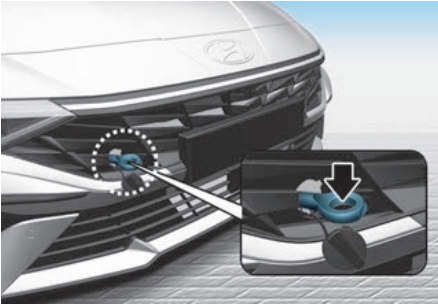

Rear

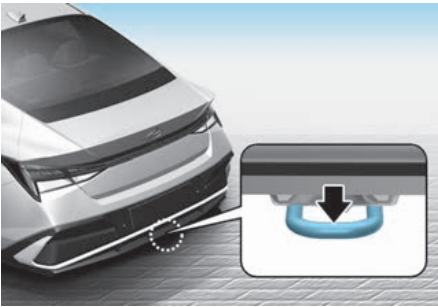

If emergency towing is necessary, contact an authorized HYUNDAI dealer or a commercial tow-truck service.

If a tow-truck service is not available in an emergency, your vehicle can be temporarily towed using a cable or chain secured to the removable towing hook at the front (or rear) of the vehicle.

Perform emergency towing using cables or chains on hard-surfaced roads for a short distance and at low speeds. The wheels, axles, power train, steering, and brakes must all be in good working condition.

WARNING

Use extreme caution when towing the vehicle with a cable or chain. A driver must be in the vehicle to steer it and operate the brakes. Passengers other than the driver must not be in the vehicle.

Always keep the following emergency towing precautions:

- Place the ignition switch in the ACC position so the steering wheel is not locked.
- Shift the gear to N (Neutral).
- Release the parking brake.
- Depress the brake pedal with more force than normal because you have reduced braking performance.
- More steering effort is required because the power steering system is disabled.
- Use a vehicle heavier than your own to tow your vehicle.
- The drivers of both vehicles must communicate with each other frequently.
- Before emergency towing, check the removable hook is not broken or damaged.
- Fasten the towing cable or chain securely to the hook.
- Do not jerk the cables, chains, or removable hook. Apply steady and even force.

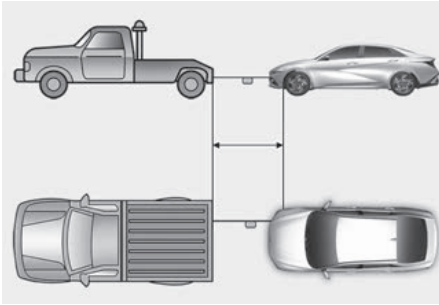

- Use a towing cable or chain less than 16 ft. (5 m) long. Attach a white or red cloth (about 12 in. (30 cm) wide) in the middle of the cable or chain for easy visibility.
- Drive carefully so the towing cable or chain remains tight during towing.
- Before towing, check the Intelligent Variable Transmission (IVT)/Dual clutch transmission for fluid leaks under your vehicle. If the Intelligent Variable Transmission (IVT)/Dual clutch transmission fluid is leaking, flatbed equipment or a towing dolly must be used.

NOTICE

Accelerate or decelerate the vehicle in a slow and gradual manner while maintaining tension on the tow rope or chain to start or drive the vehicle. Otherwise, tow hooks and the vehicle may be damaged.

NOTICE

To avoid damage to your vehicle and vehicle components when towing:

- Always pull straight ahead when using the towing hooks. Do not pull from the side or at a vertical angle.
- Do not use the towing hooks to pull the vehicle out of mud, sand, or other conditions from which the vehicle cannot be driven out under its own power.
- Limit the vehicle speed to 10 mph (15 km/h) and drive less than 1 mi. (1.5 km) when towing to avoid serious damage to the transmission.

9. Maintenance

| | |
|--|------|
| Engine Compartment..... | 9-4 |
| Maintenance services | 9-5 |
| Guide to hyundai genuine parts..... | 9-5 |
| Owner's responsibility | 9-6 |
| Owner maintenance precautions | 9-6 |
| Owner maintenance..... | 9-7 |
| Owner maintenance schedule | 9-7 |
| Scheduled maintenance services..... | 9-9 |
| Normal maintenance schedule..... | 9-11 |
| Maintenance under severe usage conditions | 9-15 |
| Explanation of scheduled maintenance items | 9-17 |
| Engine oil and filter | 9-17 |
| Drive belts..... | 9-17 |
| Fuel lines, fuel hoses and connections..... | 9-17 |
| Fuel filter..... | 9-17 |
| Vapor hose and fuel filler cap | 9-17 |
| Vacuum crankcase ventilation hoses | 9-17 |
| Air cleaner filter | 9-17 |
| Spark plugs..... | 9-17 |
| Cooling system..... | 9-17 |
| Engine coolant | 9-18 |
| Intelligent Variable Transmission fluid | 9-18 |
| Dual Clutch Transmission fluid | 9-18 |
| Brake hoses and lines | 9-18 |
| Brake fluid..... | 9-18 |
| Parking brake..... | 9-18 |
| Brake discs, pads, calipers, and rotors..... | 9-18 |
| Drive shaft and related | 9-18 |
| Suspension mounting bolts..... | 9-18 |
| Steering gear box, linkage & boots/lower arm ball joint..... | 9-18 |
| Air conditioning refrigerant..... | 9-18 |
| Engine oil..... | 9-19 |
| Checking the engine oil level..... | 9-19 |
| Checking the engine oil and filter..... | 9-20 |
| Engine coolant | 9-21 |
| Checking the coolant level..... | 9-21 |

| | |
|---|------|
| Changing coolant | 9-23 |
| Brake fluid..... | 9-23 |
| Checking the brake fluid level | 9-23 |
| Parking brake..... | 9-24 |
| Checking the parking brake..... | 9-24 |
| Washer fluid..... | 9-25 |
| Checking the washer fluid level | 9-25 |
| Air cleaner..... | 9-25 |
| Filter replacement | 9-25 |
| Cabin air filter | 9-27 |
| Filter inspection | 9-27 |
| Filter replacement | 9-27 |
| Wiper blades..... | 9-28 |
| Blade inspection | 9-28 |
| Blade replacement | 9-28 |
| Battery | 9-29 |
| For longer battery life..... | 9-30 |
| Battery capacity label | 9-31 |
| Battery recharging | 9-31 |
| Reset items | 9-32 |
| Tires and wheels..... | 9-33 |
| Tire care | 9-33 |
| Recommended cold tire inflation pressures | 9-33 |
| Check tire inflation pressure..... | 9-34 |
| Tire rotation | 9-35 |
| Wheel alignment and tire balance | 9-35 |
| Tire replacement | 9-36 |
| Wheel replacement | 9-37 |
| Tire traction..... | 9-37 |
| Tire maintenance..... | 9-37 |
| Tire sidewall labeling..... | 9-37 |
| Tire terminology and definitions | 9-40 |
| All season tires | 9-43 |
| Summer tires | 9-43 |
| Snow tires | 9-43 |

9. Maintenance

| | |
|--|------|
| Radial-ply tires | 9-44 |
| Low aspect ratio tires | 9-44 |
| Fuses..... | 9-45 |
| Instrument panel fuse replacement | 9-46 |
| Engine compartment panel fuse replacement..... | 9-46 |
| Fuse/Relay panel description..... | 9-48 |
| Light bulbs..... | 9-55 |
| Headlight, parking light, Daytime Running Light, turn signal light, side marker replacement | 9-56 |
| Side repeater light replacement | 9-57 |
| Rear combination light replacement..... | 9-57 |
| High mounted stop light replacement | 9-60 |
| License plate light bulb replacement | 9-60 |
| Interior light replacement | 9-61 |
| Appearance care..... | 9-62 |
| Exterior care | 9-62 |
| Interior care..... | 9-66 |
| Emission control system | 9-69 |
| 1. Crankcase emission control system..... | 9-69 |
| 2. Evaporative emission control system including onboard refueling vapor recovery (ORVR) | 9-69 |
| 3. Exhaust emission control system | 9-70 |
| Fuel requirements | 9-71 |
| Gasoline engine..... | 9-71 |
| California perchlorate notice | 9-73 |

Engine Compartment

Smartstream G2.0

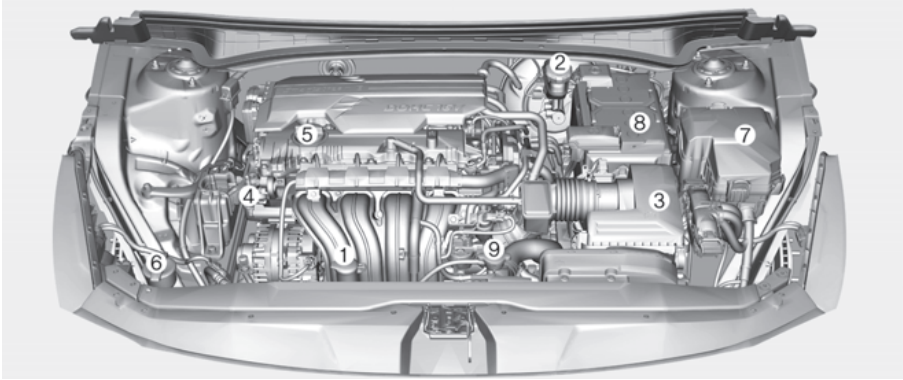

Smartstream G1.6 T-GDI

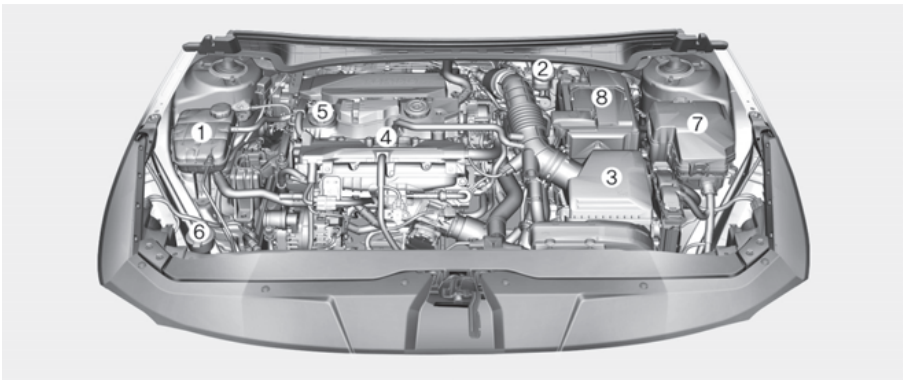

The actual engine compartment in the vehicle may differ from the illustration.

- (1) Engine coolant reservoir
- (2) Brake fluid reservoir
- (3) Air cleaner
- (4) Engine oil dipstick
- (5) Engine oil filler cap
- (6) Windshield washer fluid reservoir
- (7) Fuse box
- (8) Battery
- (9) Radiator cap

Maintenance services

Exercise the utmost care to prevent damage to your vehicle and injury to yourself whenever performing any maintenance or inspection procedures.

Have your vehicle maintained and repaired by an authorized HYUNDAI dealer. An authorized HYUNDAI dealer meets HYUNDAI's high service quality standards and receives technical support from HYUNDAI in order to provide you with a high level of service satisfaction.

Guide to hyundai genuine parts

1. What are HYUNDAI Genuine Parts?

HYUNDAI Genuine Parts are the parts used by HYUNDAI Motor Company to manufacture vehicles. They are designed and tested for the optimum safety, performance, and reliability for our customers.



2. Why Hyundai Genuine Parts?

HYUNDAI Genuine Parts are engineered and built to meet rigid manufacturing requirements. Damage caused by using imitation, counterfeit, or used salvage parts is not covered under the HYUNDAI New Vehicle Limited Warranty or any other HYUNDAI warranty.

In addition, any damage to or failure of HYUNDAI Genuine Parts caused by the installation or failure of an imitation, counterfeit or used salvage part are not covered by any HYUNDAI Warranty.



3. How can you tell if you are purchasing HYUNDAI Genuine Parts?

Look for the HYUNDAI Genuine Parts Logo on the package (see below).

HYUNDAI Genuine Parts exported to the U.S. are packaged with labels written only in English.

HYUNDAI Genuine Parts are only sold through authorized HYUNDAI Dealerships.

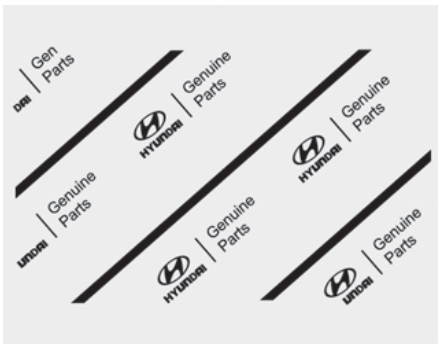

Owner's responsibility

Maintenance service and record retention are the owner's responsibility.

Retain documents that show proper maintenance has been performed on your vehicle in accordance with the scheduled maintenance service charts on the following pages. You need this information to establish your compliance with the servicing and maintenance requirements of your vehicle warranties.

Detailed warranty information is provided in your Owner's Handbook & Warranty Information booklet.

Repairs and adjustments required as a result of improper maintenance or a lack of required maintenance are not covered.

Owner maintenance precautions

Inadequate, incomplete, or insufficient servicing may result in operational problems with your vehicle that could cause vehicle damage or a collision that results in serious injury or death.

Your vehicle must not be modified in any way. Such modifications may adversely affect the performance, safety, or durability of your vehicle and may, in addition, violate conditions of the limited warranties covering the vehicle.

NOTICE

Improper owner maintenance during the warranty period may affect warranty coverage. For more information, read the separate Owner's Handbook & Warranty Information Booklet provided with the vehicle.

Owner maintenance

WARNING

Performing maintenance on the vehicle can be dangerous. If you lack sufficient knowledge, experience, or proper tools and equipment to do the work, have it done by an authorized HYUNDAI dealer. Before performing maintenance:

- Park your vehicle on level ground. Shift the vehicle to P (Park), apply the parking brake, and move the ignition switch to the LOCK/OFF position.
- Block the tires (front and back) to prevent the vehicle from moving. Remove loose clothing or jewelry that can become entangled in moving parts.
- If you must run the engine during maintenance, do it in an outdoor area or in an area with plenty of ventilation.
- Keep flames, sparks, or smoking materials away from the battery and fuel-related parts.

WARNING

Do not touch metal parts (including strut bars) while the engine is operating or hot to prevent serious injury. Turn off the engine and wait until the metal parts cool down before working on the vehicle.

The following lists are vehicle checks and inspections that should be performed by the owner or an authorized HYUNDAI dealer at the frequencies indicated to help ensure safe and dependable operation of your vehicle.

Any adverse conditions should be brought to the attention of your authorized HYUNDAI dealer as soon as possible.

These Owner Maintenance vehicle checks are generally not covered by warranties and you may be charged for labor, parts, and lubricants used.

Owner maintenance schedule

When you stop for fuel:

- Check the coolant level in the engine coolant reservoir.
- Check the windshield washer fluid level.
- Check for low or under-inflated tires.

While operating your vehicle:

- Note any changes in the sound of the exhaust or any smell of exhaust fumes in the vehicle.
- Check for vibrations in the steering wheel. Notice if there is any increased steering effort or looseness in the steering wheel, or change in its straight-ahead position.
- Notice if your vehicle constantly turns slightly or "pulls" to one side when traveling on a smooth, level road.
- When stopping, listen and check for unusual sounds, pulling to one side, increased brake pedal travel, or "hard-to-push" brake pedal.
- If any slipping or changes in the operation of your transmission occurs, check the transmission fluid level.
- Check the Intelligent Variable Transmission (IVT)/Dual clutch transmission P (Park) function.
- Check the parking brake.
- Check for fluid leaks under your vehicle (water dripping from the air conditioning system during or after use is normal).

At least monthly:

- Check the coolant level in the engine coolant reservoir.
- Check the operation of all exterior lights, including the headlights, brake lights, turn signals, and hazard warning flashers.
- Check the inflation pressures of all tires including the spare for tires that are worn, show uneven wear, or are damaged.
- Check for loose wheel nuts.

WARNING

Be careful when checking your coolant level if the engine is hot. This may result in coolant being blown out of the opening and cause serious burns and other injuries.

At least twice a year:

- Check the radiator, heater, and air conditioning hoses for leaks or damage.
- Check the windshield washer spray and wiper operation. Clean the wiper blades with a clean cloth dampened with washer fluid.
- Check the headlight alignment.
- Check the muffler, exhaust pipes, shields, and clamps.
- Check the seat belts for wear and function.

At least once a year:

- Clean the body and door drain holes.
- Lubricate the door hinges and hood hinges.
- Lubricate the door, hood locks, and latches.
- Lubricate the door rubber weather strips.
- Lubricate the door checker.
- Check the air conditioning system.
- Inspect and lubricate the transmission linkage and controls.
- Clean the battery and terminals.
- Check the brake fluid level.

Scheduled maintenance services

If any of the following conditions apply, follow the Maintenance Under Severe Usage Conditions.

- Repeated driving short distance of less than 5 mi. (8 km) in normal temperature or less than 10 mi. (16 km) in freezing temperature
- Extensive engine idling or low speed driving for long distances
- Driving on rough, dusty, muddy, unpaved, graveled, or salt-spread roads
- Driving in areas using salt or other corrosive materials or in very cold weather
- Driving in heavy dust conditions
- Driving in heavy traffic
- Driving on uphill, downhill, or mountain roads
- Towing a trailer or using a camper, or driving with loads on the roof
- Driving as a patrol car, taxi, or other commercial use of vehicle towing
- Frequently driving at high speeds or rapid acceleration/deceleration
- Frequently driving in stop-and-go traffic
- Using engine oil that is not recommended (mineral type, semi-synthetic, lower grade spec, etc.)

i Information

After 10 years or 100,000 mi., use severe maintenance schedule.

i Information

- As it is normal for engine oil to be consumed during driving, the engine oil level should be checked on regular basis.
 - The engine oil change interval for normal operating conditions is based on the use of the recommended engine specification.
 - The vehicle may be equipped with the Oil Life Management System that predicts engine oil life based on the driver's driving history and alerts the driver to change engine oil.
 - If the deterioration of the engine oil increases depending on the driver's driving severity, the remaining oil life alert appears on the instrument cluster before the normal engine oil replacement interval. Have the engine oil and filter changed by an authorized HYUNDAI dealer.
 - Oil Life Management System works when the recommended engine oil is used. So, if recommended engine oil is not used, replace the engine oil according to the maintenance schedule under severe usage condition.

Also, check the amount of engine oil regularly as this system assumes that the engine oil is being filled normally.
 - Always reset the remaining engine oil life whenever the engine oil is changed. Otherwise, the indication of remaining Oil life in the Oil Life Management System may not be accurate. To reset the Engine Oil Change Reminder, select 'RESET' from the infotainment system screen. Then, select 'Yes' when the message "Has the engine oil been changed? Press [Yes] to reset the oil life." appears on the screen.
 - If there is no alert until the maximum maintenance interval, have the vehicle checked by an authorized HYUNDAI dealer.
-

Normal maintenance schedule

| MAINTENANCE INTERVALS | Months | 12 | 24 | 36 | 48 | 60 | 72 | 84 | 96 | 108 | 120 | 132 | 144 | 156 | |
|---|--|--|----|----|----|----|----|----|-----|-----|-----|-----|-----|-----|--|
| | Miles×1,000 | 8 | 16 | 24 | 32 | 40 | 48 | 56 | 64 | 72 | 80 | 88 | 96 | 104 | |
| | Km×1,000 | 13 | 26 | 39 | 52 | 65 | 78 | 91 | 104 | 117 | 130 | 143 | 156 | 169 | |
| MAINTENANCE ITEM | | | | | | | | | | | | | | | |
| Engine oil and engine oil filter ^{*1*} | Smartstream G2.0 Atkinson | R | R | R | R | R | R | R | R | R | R | R | R | R | |
| | Smartstream G1.6 T-GDi | R | R | R | R | R | R | R | R | R | R | R | R | R | |
| Fuel additives ^{*3} | Add fuel additives every 8,000 mi. (13,000 km) or 12 months | | | | | | | | | | | | | | |
| Intercooler, in/out hose | Smartstream G1.6 T-GDi | At first, inspect at 5,000 mi. (8,000 km) or 6 months. Thereafter, inspect every 20,000 mi. (32,000 km) or 24 months | | | | | | | | | | | | | |
| Air cleaner filter | I I R I I R I I R I I R I | | | | | | | | | | | | | | |
| Spark plugs | Smartstream G2.0 Atkinson | Replace every 96,000 mi. | | | | | | | | | | | | | |
| | Smartstream G1.6 T-GDi | Replace every 48,000 mi. | | | | | | | | | | | | | |
| Rotate tires | Rotate tires every 8,000 mi. (13,000 km) or 12 months | | | | | | | | | | | | | | |
| Cabin air filter | R R R R R R | | | | | | | | | | | | | | |
| Drive belts ^{*4} | At first, inspect at 48,000 mi. (78,000 km) or 72 months. Thereafter, inspect every 8,000 mi. (13,000 km) or 12 months | | | | | | | | | | | | | | |

*1 Requires <API SN PLUS (or above) Full synthetic> grade engine oil. If a lower grade engine oil (mineral oil including Semi-synthetic) is used, then the engine oil and engine oil filter must be replaced as indicated severe maintenance condition.

*2 Never add any additives to the engine oil. Engine oil additives can change the properties of engine oil and may cause serious engine failure.

*3 If TOP TIER Detergent Gasoline is not available, one bottle of additive is recommended. Additives are available from your authorized HYUNDAI dealer along with information on how to use them. Do not mix other additives.

*4 The drive belt should be replaced when cracks occur or tension is reduced excessively.

R: Replace or change.

I: Inspect and if necessary, adjust, correct, clean or replace.

***i* Information**

- As it is normal for engine oil to be consumed during driving, the amount of engine oil should be checked regularly.
 - The replacement cycle of engine oil is set by the period which the performance of our recommended engine oil is maintained. So, if recommended engine oil is not used, a replacement is required as indicated severe usage condition.
-

| MAINTENANCE INTERVALS | Months | 12 | 24 | 36 | 48 | 60 | 72 | 84 | 96 | 108 | 120 | 132 | 144 | 156 |
|--|---|----|----|----|----|----|----|----|-----|-----|-----|-----|-----|-----|
| | Miles×1,000 | 8 | 16 | 24 | 32 | 40 | 48 | 56 | 64 | 72 | 80 | 88 | 96 | 104 |
| | Km×1,000 | 13 | 26 | 39 | 52 | 65 | 78 | 91 | 104 | 117 | 130 | 143 | 156 | 169 |
| MAINTENANCE ITEM | | | | | | | | | | | | | | |
| Engine coolant | At first, replace at 120,000 mi. (200,000 km) or 120 months. After that, replace every 24,000 mi. (39,000 km) or 24 months | | | | | | | | | | | | | |
| Battery condition | I | I | I | I | I | I | I | I | I | I | I | I | I | I |
| Brake lines, hoses and connections | I | I | I | I | I | I | I | I | I | I | I | I | I | I |
| Disc brakes and pads | I | I | I | I | I | I | I | I | I | I | I | I | I | I |
| Steering gear rack, linkage and boots / lower arm ball joint, upper arm ball joint | I | I | I | I | I | I | I | I | I | I | I | I | I | I |
| Driveshaft and boots | | I | | I | | I | | I | | I | | I | | |
| Suspension mounting bolts | I | I | I | I | I | I | I | I | I | I | I | I | I | I |
| Air conditioner refrigerant | I | I | I | I | I | I | I | I | I | I | I | I | I | I |
| Air conditioner compressor | I | I | I | I | I | I | I | I | I | I | I | I | I | I |
| Exhaust pipe and muffler | I | I | I | I | I | I | I | I | I | I | I | I | I | I |
| Intelligent variable transmission fluid (if equipped) *1 | No check, No service required | | | | | | | | | | | | | |
| Dual clutch transmission fluid (if equipped) *2 | | | | I | | | | | I | | | | I | |

*1 Use only the specified intelligent variable transmission fluid. (Refer to "Recommended lubricants and capacities" section in chapter 2 or the label in the engine compartment.)

*2 Dual clutch transmission fluid should be changed anytime they have been submerged in water.

R: Replace or change.

I: Inspect and if necessary, adjust, correct, clean or replace.

| MAINTENANCE INTERVALS | Months | 12 | 24 | 36 | 48 | 60 | 72 | 84 | 96 | 108 | 120 | 132 | 144 | 156 |
|---|---|----|----|----|----|----|----|----|-----|-----|-----|-----|-----|-----|
| | Miles×1,000 | 8 | 16 | 24 | 32 | 40 | 48 | 56 | 64 | 72 | 80 | 88 | 96 | 104 |
| | Km×1,000 | 13 | 26 | 39 | 52 | 65 | 78 | 91 | 104 | 117 | 130 | 143 | 156 | 169 |
| MAINTENANCE ITEM | | | | | | | | | | | | | | |
| Vapor hose, fuel filler cap and fuel tank | | I | | | I | | | | I | | | | I | |
| Fuel tank air filter | | I | | | I | | | | I | | | | I | |
| Fuel filter *1 | - | | | | | | | | | | | | | |
| Fuel lines, hoses and connections | | I | | | I | | | | I | | | | I | |
| Parking brake | | I | | | I | | | | I | | | | I | |
| Brake fluid | Inspect every 8,000 mi. (13,000 km) or 12 months, Replace every 48,000 mi. (78,000 km) or 48 months | | | | | | | | | | | | | |

*1 The fuel filter is considered to be maintenance free but periodic inspection is recommended for this maintenance schedule depends on fuel quality. If there are some important safety matters like fuel flow restriction, surging, loss of power, hard starting problem etc, replace the fuel filter immediately regardless of maintenance schedule and consult an authorized HYUNDAI dealer for details.

R: Replace or change.

I : Inspect and if necessary, adjust, correct, clean or replace.

Maintenance under severe usage conditions

The following items must be serviced more frequently on cars mainly used under severe driving conditions. Refer to the chart below for the appropriate maintenance intervals.

R : Replace

I : Inspect and if necessary, adjust, correct, clean or replace

| Maintenance item | | Maintenance operation | Maintenance intervals | Driving condition |
|---|---------------------------|-----------------------|--|------------------------------------|
| Engine oil and filter ** | Smartstream G2.0 Atkinson | R | Replace every 5,000 mi. (8,000 km) or 6 months | A, B, C, D, E, F, G, H, I, J, K, L |
| | Smartstream G1.6 T-GDi | | | D, H, I, L |
| Air cleaner filter | | I | Inspect more frequently depending on the condition | C, E |
| Spark plugs | | R | Inspect more frequently depending on the condition | A, B, F, G, H, I, K |
| Steering gear rack, linkage and boots | | I | Inspect more frequently depending on the condition | C, D, E, F, G |
| Front suspension ball joints | | I | Inspect more frequently depending on the condition | C, D, E, F, G |
| Disc brakes and pads, calipers and rotors | | I | Inspect more frequently depending on the condition | C, D, E, G, H |
| Parking brake | | I | Inspect more frequently depending on the condition | C, D, G, H |
| Driveshaft and boots | | I | Inspect more frequently depending on the condition | C, D, E, F, G, H, I, J |

| Maintenance item | Maintenance operation | Maintenance intervals | Driving condition |
|---|-----------------------|--|---------------------------|
| Cabin air filter | R | Inspect more frequently depending on the condition | C, E, G |
| Intelligent variable transmission fluid (if equipped) | R | Replace every 60,000 mi. (90,000 km) | A, C, D, E, F, G, H, I, K |
| Dual clutch transmission fluid (if equipped) | R | Replace every 80,000 mi. (120,000km) | C, D, F, G, H, I, J |

*1 Requires <API SN PLUS (or above) Full synthetic> grade engine oil. If a lower grade engine oil (mineral oil including Semi-synthetic) is used, then the engine oil and engine oil filter must be replaced as indicated severe maintenance condition.

Severe driving conditions

- A. Repeated driving short distance of less than 5 mi. (8 km) in normal temperature or less than 10 mi. (16 km) in freezing temperature
- B. Extensive engine idling or low speed driving for long distances
- C. Driving on rough, dusty, muddy, unpaved, graveled, or salt-spread roads
- D. Driving in areas using salt or other corrosive materials or in very cold weather
- E. Driving in heavy dust conditions
- F. Driving in heavy traffic
- G. Driving on uphill, downhill, or mountain roads
- H. Towing a trailer or using a camper, or driving with loads on the roof
- I. Driving as a patrol car, taxi, or other commercial use of vehicle towing
- J. Frequently driving at high speeds or rapid acceleration/deceleration
- K. Frequently driving in stop-and-go traffic
- L. Using engine oil that is not recommended (mineral type, semi-synthetic, lower grade spec, etc.)

Explanation of scheduled maintenance items

Engine oil and filter

The engine oil and filter should be changed at the intervals specified in the maintenance schedule. If the vehicle is driven in severe conditions, more frequent oil and filter changes are required.

Drive belts

Inspect all drive belts for evidence of cuts, cracks, excessive wear, or oil saturation. Replace them if necessary.

Check the drive belts periodically for proper tension and adjusted as necessary.

WARNING

Always turn off the engine before inspecting the drive belts.

Fuel lines, fuel hoses and connections

Check the fuel lines, fuel hoses, and connections for leakage and damage. Have an authorized HYUNDAI dealer replace any damaged or leaking parts immediately.

Fuel filter

The fuel filter is considered to be maintenance free but periodic inspection is recommended depending on the fuel quality. If there is fuel flow restriction, surging, loss of power, or hard starting, contact an authorized HYUNDAI dealer to have the fuel filter replaced immediately.

Vapor hose and fuel filler cap

The vapor hose and fuel filler cap should be inspected at intervals specified in the maintenance schedule. Your HYUNDAI dealer helps determine if replacement is needed.

Vacuum crankcase ventilation hoses

Visually check for proper installation, chafing, cracks, deterioration, and any leakage. Replace any deteriorated or damaged parts immediately.

Air cleaner filter

The air cleaner filter should be replaced by an authorized HYUNDAI dealer.

Spark plugs

Be sure to install new spark plugs with the correct heat range.

When installing new spark plugs, make sure the ignition coils are clean and free of any oil or debris. Clean and wipe off the bottom portion of the ignition coil to prevent any contamination with the spark plug during installation.

WARNING

Do not remove spark plugs from the vehicle when the engine is hot. You may damage the engine and may also risk burn injury.

Cooling system

Check the cooling system components such as radiator, coolant reservoir, hoses, and connections for leakage and damage. Replace any damaged parts.

Engine coolant

The coolant should be changed at intervals specified in the maintenance schedule.

Intelligent Variable Transmission fluid

 if equipped

Intelligent variable transmission fluid should not be checked under normal usage conditions.

Have the Intelligent variable transmission fluid changed by an authorized HYUNDAI dealer according to the maintenance schedule.

Dual Clutch Transmission fluid

 if equipped

Dual clutch transmission fluid should not be checked under normal usage conditions.

Have the Dual clutch transmission fluid changed by an authorized HYUNDAI dealer according to the maintenance schedule.

Brake hoses and lines

Visually check for proper installation, chafing, cracks, deterioration, and any leakage. Replace any deteriorated or damaged parts immediately.

Brake fluid

Check the brake fluid level in the brake fluid reservoir. The level should be between the MIN and the MAX marks on the side of the reservoir. Use only hydraulic brake fluid conforming to DOT 4 specification.

Parking brake

Inspect the parking brake system including the parking brake pedal and cables.

Brake discs, pads, calipers, and rotors

Check the pads, the disc, and the rotor for any excessive wear-out. Inspect calipers for any fluid leakage.

Drive shaft and related

Check the drive shaft, boots, clamps, rubber couplings, and center-bearing rubber for cracks, deterioration, or damage. Replace any damaged parts and if necessary, repack the grease.

Suspension mounting bolts

Check the suspension connections for looseness or damage. Retighten to the specified torque.

Steering gear box, linkage & boots/lower arm ball joint

With the vehicle stopped and the engine off, check for excessive free-play in the steering wheel. Check the linkage for bends or damage. Check the dust boots and ball joints for deterioration, cracks, or damage.

Replace any damaged parts.

Air conditioning refrigerant

Check the air conditioning lines and connections for leakage and damage.

Engine oil

Checking the engine oil level

Engine oil is used for lubricating, cooling, and operating various hydraulic components in the engine. Engine oil consumption while driving is normal, and it is necessary to check and refill the engine oil regularly. Also, check and refill the oil level within the recommended maintenance schedule to prevent deterioration of oil performance.

Check the engine oil following the below procedure.

1. Follow all of the oil manufacturer's precautions.
2. Make sure the vehicle is on the level ground in P (Park) with the parking brake set and the wheels blocked.
3. Turn the engine on and warm the engine up until the coolant temperature reaches a constant normal temperature.
4. Turn the engine off, and remove the oil filler cap and pull the dipstick out. Wait for 15 minutes for the oil to return to the oil pan.
5. Wipe the dipstick clean and re-insert it fully.
6. Pull the dipstick out again and check the level. The level should be between F (Full) and L (Low).

Smartstream G2.0

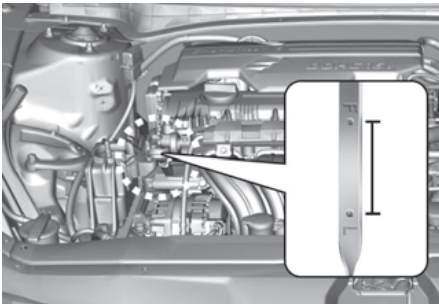

Smartstream G1.6 T-GDI

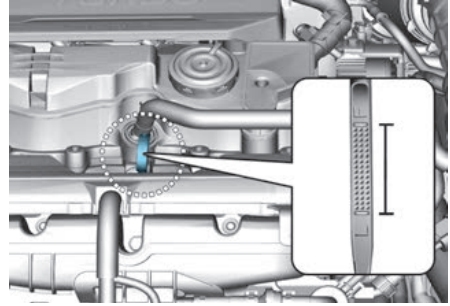

7. If the oil level is below the L, add enough oil to bring the level to F.

Smartstream G2.0

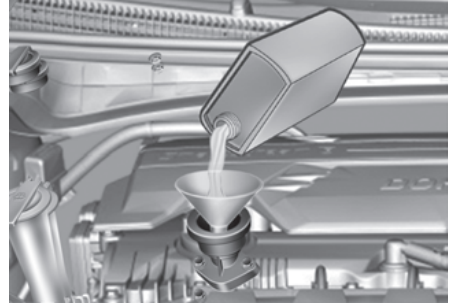

Smartstream G1.6 T-GDI

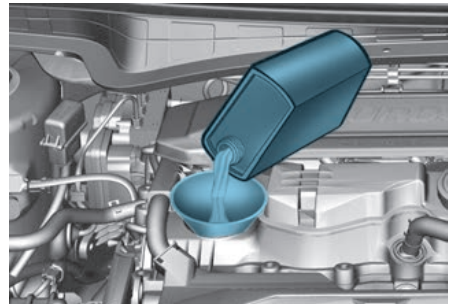

i Information

Use only the specified engine oil (Refer to the "Recommended lubricants and capacities" section in chapter 10).

NOTICE

To prevent damage to your engine:

- Do not spill engine oil when adding or changing engine oil. Wipe off spilled oil immediately.
- The engine oil consumption may increase while you break in the new vehicle, and it should stabilize after driving 4,000 mi. (6,000 km).
- The engine oil consumption may be affected by driving habits, climate conditions, traffic conditions, and oil quality. Inspect the engine oil level regularly and refill if necessary.

Checking the engine oil and filter



- The lubrication, rust prevention, cooling, and cleaning effect of the engine oil will gradually degrade during its use. Have the engine oil and filter changed by an authorized HYUNDAI dealer according to the Oil Life Management System instructions or the Maintenance Schedule at the beginning of this chapter.
- If the maintenance schedule to replace engine oil is exceeded, the engine oil performance may deteriorate, and the engine condition may be affected. Therefore, replace the engine oil according to the maintenance schedule.

- To keep the engine in optimal condition, use the recommended engine oil and filter. If the recommended engine oil and filter are not used, replace them according to the Maintenance Schedule Under Severe Usage Conditions.
- The purpose of the maintenance schedule for engine oil replacement is to prevent oil deterioration and it is irrelevant to oil consumption. Check and refill engine oil regularly.

i Information

When the oil pressure is low due to insufficient engine oil, the Engine Oil

Pressure () warning light will illuminate.

In addition, the enhanced engine protection system, which limits the engine's power is activated and the

Malfunction Indicator Lamp () will illuminate when the vehicle is driven in this state continuously. When the engine oil pressure is restored, the warning light and the enhanced engine protection system will turn off after the engine is restarted. (Smartstream G1.6 T-GDi)

WARNING

Allow the engine to cool before replacing the oil.

NOTICE

Never add any additives to the engine oil. Engine oil additives can change the properties of engine oil and may cause serious engine failure.

Engine coolant

The high pressure cooling system has a reservoir filled with year-round antifreeze coolant.

Check the antifreeze protection and coolant level at least once a year, before the winter season or before traveling to a colder climate.

Checking the coolant level

Smartstream G2.0

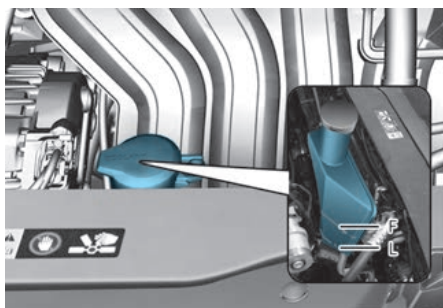

Smartstream G1.6 T-GDI

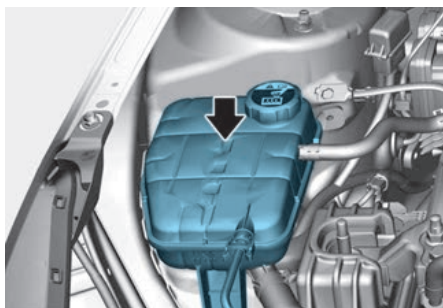

Check the condition and connections of all cooling system hoses and heater hoses. Replace any swollen or deteriorated hoses.

The coolant level should be filled between the MAX and the MIN marks on the side of the coolant reservoir when the engine is cool.

If the coolant level is low, add enough distilled (deionized) water mixed with antifreeze to bring the level to the MAX mark. If frequent additions are required, contact an authorized HYUNDAI dealer.

WARNING



Never remove the engine coolant reservoir cap, radiator cap, or drain plug while the engine and radiator are hot. Hot coolant and steam may blow out under pressure, causing serious injury.

Turn the vehicle off and wait until the engine cools down. Use extreme care when removing the engine coolant reservoir cap and radiator cap. Wrap a thick towel around it, and turn it counterclockwise slowly to the first stop. Step back while the pressure is released from the cooling system. When you are sure all the pressure has been released, press down on the cap using a thick towel, and continue turning counterclockwise to remove it.

Information

The coolant level is influenced by the engine temperature. Before checking or refilling the coolant, turn off the engine and allow the engine to cool.

WARNING



Keep hands, clothing, and tools away from the rotating fan blades of the cooling fan.

Always turn off the vehicle unless the vehicle has to be inspected with the engine on. The cooling fan may operate automatically if the negative (-) battery terminal is not disconnected.

WARNING

Make sure the coolant cap is properly closed after refilling coolant. Otherwise, the engine may be overheated while driving.

1. Check if the coolant cap label is straight in front.

Engine compartment front view



2. Make sure that the tiny protrusions inside the coolant cap is securely interlocked.

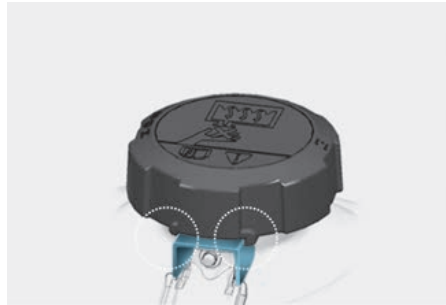

Recommended coolant

- When adding coolant, use only deionized water, distilled water, or soft water for your vehicle and never mix hard water in the coolant filled at the factory.
- An incorrect coolant mixture may result in severe malfunction or engine damage.
- The engine in your vehicle has aluminum engine parts and must be protected by a phosphate-based ethylene glycol coolant to prevent corrosion and freezing.
- Do not use alcohol or methanol coolant or mix them with the specified coolant.
- Do not use a solution that contains more than 60 % antifreeze or less than 35 % antifreeze, which could reduce the effectiveness of the solution.

For mixing percentage, refer to the following table:

| Ambient Temperature | Mixture Percentage (volume) | |
|---------------------|-----------------------------|-------|
| | Antifreeze | Water |
| 5 °F (-15 °C) | 35 | 65 |
| -13 °F (-25 °C) | 40 | 60 |
| -31 °F (-35 °C) | 50 | 50 |
| -49 °F (-45 °C) | 60 | 40 |

i Information

If in doubt about the mix ratio, a 50 % water and 50 % antifreeze mix is the easiest to mix together because it is the same quantity for each.

Changing coolant

Have the coolant changed by an authorized HYUNDAI dealer according to the Maintenance Schedule.

NOTICE

To prevent damage to engine parts, put a thick towel around the engine coolant cap before refilling the coolant to prevent the coolant from overflowing into engine parts, such as the alternator.

Brake fluid

Checking the brake fluid level

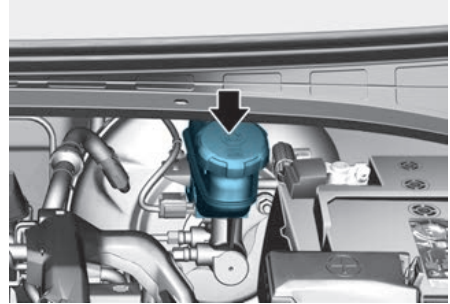

Check the fluid level in the reservoir periodically. The fluid level must be between the MAX and the MIN marks on the side of the reservoir.

Before removing the reservoir cap and adding brake fluid, clean the area around the reservoir cap thoroughly to prevent brake fluid contamination.

If the level is low, add the specified brake fluid to the MAX level. If the fluid level is excessively low or frequent additions are required, have the brake system inspected by an authorized HYUNDAI dealer.

⚠ WARNING

If brake fluid comes in contact with your eyes, flush your eyes with clean water for at least 15 minutes and get immediate medical attention.

NOTICE

- Do not allow brake fluid to contact the vehicle's body paint, because paint damage may occur.
 - Never use brake fluid that has been exposed to open air for an extended time and dispose of it properly.
 - Do not use the wrong type of brake fluid. A few drops of mineral based oil such as engine oil in your brake system may damage the brake system parts.
-

i Information

Use only the brake fluid specified in the "Recommended lubricants and capacities" section in chapter 10.

Parking brake

Checking the parking brake

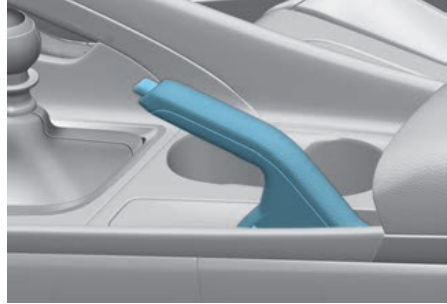

Check the stroke of the parking brake by counting the number of "clicks" heard while fully applying it from the released position. Also, the parking brake alone should securely hold the vehicle on a fairly steep grade. If the stroke is more or less than specified, have the system be inspected by an authorized HYUNDAI dealer.

Stroke : 5-8 "clicks" at a force of 44 lbs (20 kg, 196 N)

Washer fluid

Checking the washer fluid level

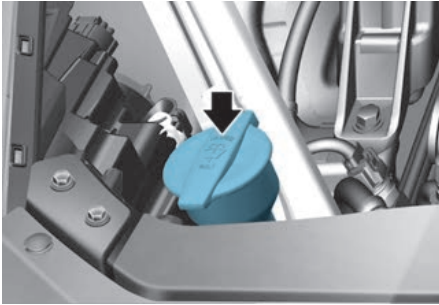

Check the fluid level in the washer fluid reservoir and add fluid if necessary. Plain water can be used during summer months if washer fluid is not available. However, use washer fluid with antifreeze in cold climates to prevent freezing.

WARNING

To prevent serious injury or death:

- Do not use engine coolant or antifreeze in the washer fluid reservoir. Engine coolant can severely limit your visibility when sprayed on the windshield and may cause loss of vehicle control resulting in a collision.
- Do not allow sparks or flame to contact the washer fluid or the washer fluid reservoir. Washer fluid may contain alcohol and can be flammable.
- Do not drink washer fluid and avoid contact with skin.
- Keep washer fluid away from children and animals.

Air cleaner

Filter replacement

Type A

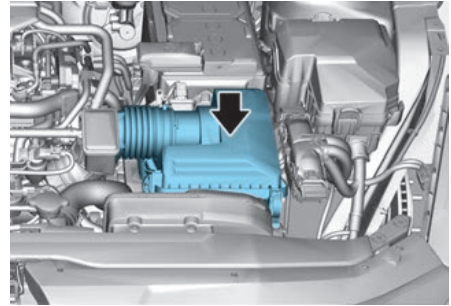

Type B (N Line)

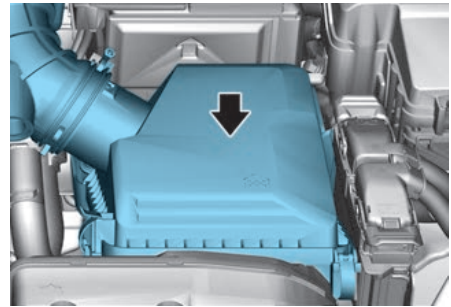

The air cleaner filter can be cleaned for inspection using compressed air. Do not attempt to wash or rinse it, because water can damage the filter. If soiled, replace the air cleaner filter.

1. Loosen the air cleaner cover attaching clip (1) and open the cover.

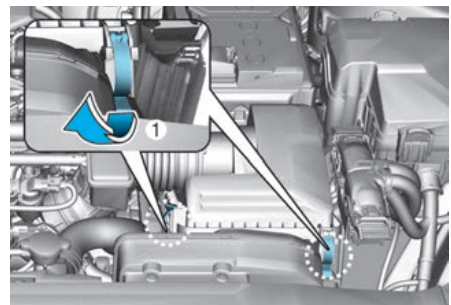

2. Replace the air cleaner filter.

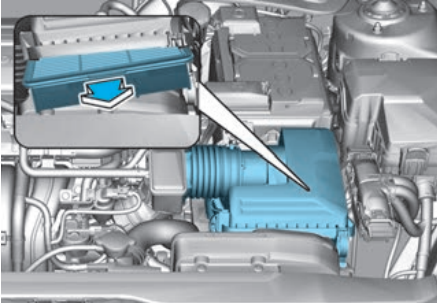

3. Insert the air cleaner cover in the hinge (2) and engage the clip (1) after closing the cover.

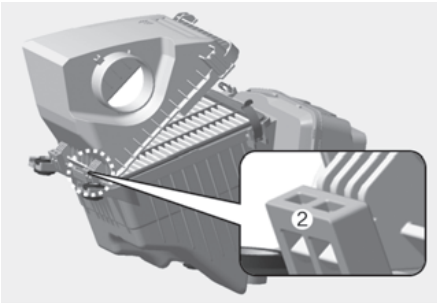

4. Check that the cover is firmly installed.

i Information

If the vehicle is operated in extremely dusty or sandy areas, replace the element more often than the usual recommended intervals (refer to the "Maintenance under severe usage conditions" section in this chapter).

NOTICE

- Do not drive with the air cleaner filter removed. This may result in excessive engine wear.
- When removing the air cleaner filter, be careful that dust or dirt does not enter the air intake. It may cause damage.
- Use HYUNDAI genuine parts or the equivalent specified for your vehicle. Use of non-genuine parts may damage the air flow sensor.

Cabin air filter

Filter inspection

The cabin air filter must be replaced according to the Maintenance Schedule. If the vehicle operates in severely air-polluted cities or on dusty rough roads for a long time, have it inspected more frequently and replaced immediately. Replace the cabin air filter by following the procedure below and be careful to avoid damaging other components.

Filter replacement

1. Open the glove box.
2. Push in both sides of the glove box to release the glove box stopper pins and allow the glove box to hang open.

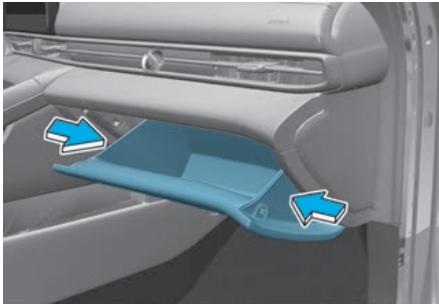

3. Press and hold the lock on the right side of the cover.
4. Pull out the cover.

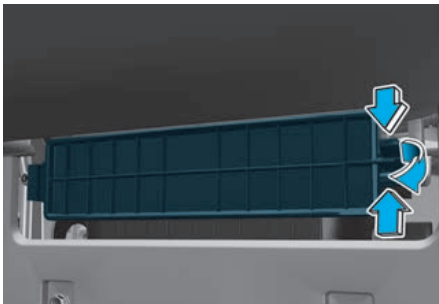

5. Replace the cabin air filter.



6. Reassemble in the reverse order of disassembly.

NOTICE

Install a new cabin air filter with the arrow symbol (↓) facing down, to improve effectiveness.

Wiper blades

Blade inspection

Contamination of the windshield or wiper blades with foreign substances may reduce the effectiveness of the windshield wipers.

Common sources of contamination are insects, tree sap, and hot wax treatments used by some commercial car washes. If the blades are not wiping properly, clean both the window and the blades with glass cleaner or mild detergent, and rinse thoroughly with clean water. Replace blades as needed.

NOTICE

To prevent damage to the wiper blades, arms, or other components, do not:

- Use gasoline, kerosene, paint thinner, or other solvents on or near them.
- Attempt to move the wipers manually.

Blade replacement

When the wipers no longer clean adequately, the blades may be worn or cracked. Replace the wipers with new ones.

NOTICE

To prevent damage:

- Never use non-specified wiper blades.
- Lift the wiper arms when in the top wiping position.
- Always return the wiper arms to the windshield before driving.

Front windshield wiper blade replacement

This vehicle has a "hidden" wiper design that cannot be lifted when in their bottom resting position.

1. Within 20 seconds of turning off the engine, lift and hold the wiper lever up to the MIST position for about 2 seconds until the wipers move to the top wipe position.

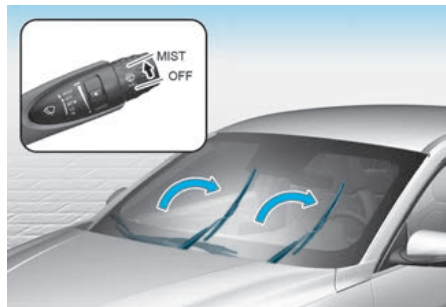

2. Lift the wipers off the windshield.
3. Rotate the wiper blade to access the clip.

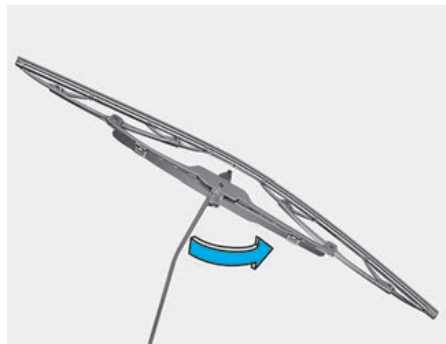

4. While pushing the clip (1), pull down the wiper blade (2).

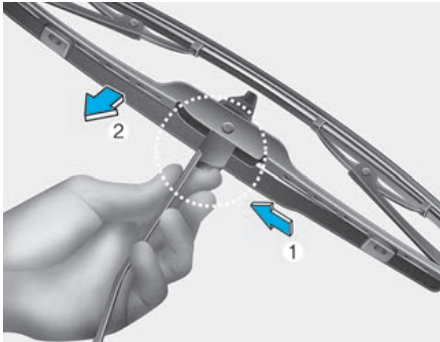

5. Remove the wiper blade from the wiper arm.



6. Install a new wiper blade assembly in the reverse order of removal.
 7. Gently put down the wiper back onto the windshield.
 8. Turn the wipers to any ON position to return the wiper arms to the bottom resting position.

Battery

⚠ WARNING

To prevent serious injury or death to you or bystanders when working near or handling the battery:



Always read and follow instructions carefully when handling a battery.



Wear eye protection designed to protect the eyes from acid splashes.



Keep all flames, sparks, or smoking materials away from the battery.



Hydrogen is always present in battery cells, is highly combustible, and may explode if ignited.



Keep batteries out of reach of children.



Batteries contain sulfuric acid that is highly corrosive. Do not allow acid to contact your eyes, skin, or clothing.

If acid gets into your eyes, flush your eyes with clean water for at least 15 minutes and get immediate medical attention. If acid gets on your skin, thoroughly wash the area. If you feel pain or a burning sensation, get medical attention immediately.

- Lift a battery with a battery carrier or with your hands on opposite corners. When lifting a plastic-cased battery, excessive pressure on the case may cause battery acid to leak.
 - Do not attempt to jump start your vehicle if your battery is frozen.
 - Never attempt to recharge the battery when the vehicle's battery cables are connected to the battery.
 - The electrical ignition system works with high voltage. Never touch these components with the engine running or when the ignition switch is in the ON position.
 - Do not allow the (+) and (-) jumper cables to touch. It may cause sparks.
 - The battery may rupture or explode when you jump start with a low or frozen battery.
 - Leaked battery electrolyte due to repeated driving on sharp curves (for example, on circuits) may cause safety problem. Avoid repeated driving on sharp curves.
-

NOTICE

To prevent battery damage:

- Always fully charge the battery and store indoors when you do not plan to use the vehicle for a long time if the outside temperature is low enough to cause the battery to freeze.
 - Never connect unauthorized devices to the battery.
 - Always fully charge the battery to prevent battery case damage in low temperature areas.
 - Do not tilt the battery.
-

For longer battery life

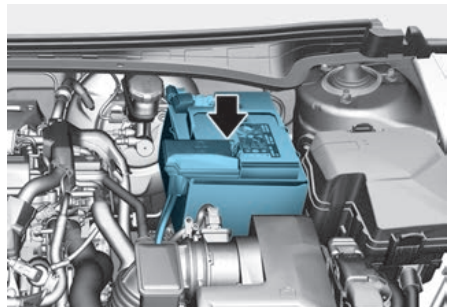

- Keep the battery top clean and dry.
- Keep the terminals and connections clean, tight, and coated with petroleum jelly or terminal grease.
- Rinse any spilled electrolyte from the battery immediately with a solution of water and baking soda.
- If the vehicle is not going to be used for an extended period of time, disconnect the battery cables.

Battery capacity label

Type A



Type B



- CMF60L-DIN/AGM70L-DIN: The HYUNDAI model name of battery
- 12V: The nominal voltage
- 9. 60Ah (20HR)/70Ah (20HR): The nominal capacity (in Ampere hours)
- 10. CCA: The cold-test current in amperes by SAE
- 11. 550A/760A: The cold-test current in amperes by EN
- 12. RC 92min/RC 120min: The nominal capacity (in Ampere hours)

Battery recharging

By battery charger

Your vehicle has a maintenance-free, calcium-based battery.

- If the battery becomes discharged over a short time (because, for example, the headlights or interior lights are left on while the vehicle is not used), recharge it by slow charging (trickle) for 10 hours.
- If the battery gradually discharges because of high electrical load while the vehicle is being used, recharge at 20-30 A for two hours.

! WARNING

To prevent the risk of serious injury or death from explosions or acid burns:

- Before performing maintenance or recharging the battery, turn off all accessories and stop the engine.
- Keep all flames, sparks, or smoking materials away from the battery.
- Always work outdoors or in an area with plenty of ventilation.
- Wear eye protection when checking the battery during charging. Do not contact the battery. This may result in serious injury.
- Remove the battery from the vehicle and place it in a well ventilated area.
- Watch the battery during charging, and stop or reduce the charging rate if the battery cells begin boiling violently.
- Remove the negative battery cable first and install it last when the battery is disconnected. Disconnect the battery charger in the following order:
 1. Turn off the battery charger main switch.
 2. Unhook the negative clamp from the negative battery terminal.
 3. Unhook the positive clamp from the positive battery terminal.

NOTICE

AGM battery (if equipped)

Absorbent Glass Mat (AGM) batteries are maintenance-free and should be serviced by an authorized HYUNDAI dealer. Only charge using fully automatic battery chargers that are specifically for AGM batteries.

CAUTION

- Do not open or remove the cap on top of the battery. This may cause leaks of internal electrolyte that could result in severe injury.
 - Do not charge the AGM battery with a general charger. It may damage or explode the AGM battery. Only charge the AGM battery with a charger that has AGM battery setting.
-

By jump starting

After a jump start from a good battery, drive the vehicle for 30 minutes or operate at idle for at least 60 minutes before it is shut off. The vehicle may not restart if you shut it off before the battery had a chance to adequately recharge. Refer to the "Jump starting" section in chapter 8 for more information on jump starting procedures.

Information



An inappropriately disposed battery may be harmful to the environment and human health. Always dispose of a used battery according to your local law(s) or regulations.

Reset items

The following items may need to be reset after the battery has been discharged or disconnected:

- Auto up/down window (refer to chapter 5)
- Sunroof (refer to chapter 5)
- Trip computer (refer to chapter 4)
- Climate control additional features (refer to chapter 5)

Tires and wheels

WARNING

Tire failure may cause loss of vehicle control and result in a collision. To reduce risk of serious injury or death:

- Inspect your tires monthly for proper inflation as well as wear and damage.
- The recommended cold tire pressure for your vehicle can be found in this manual and on the tire label located on the driver's side center pillar. Always use a tire pressure gauge to measure tire pressure. Tires with too much or too little pressure wear unevenly causing poor handling.
- Check the pressure of the spare every time you check the pressure of the other tires on your vehicle.
- Replace tires that are worn, show uneven wear, or are damaged. Worn tires may cause loss of braking effectiveness, steering control, or traction.
- Always replace tires with the same size, type, construction, and tread pattern as each tire that was originally supplied with this vehicle. Using tires and wheels other than the recommended sizes may cause unusual handling characteristics, poor vehicle control, or negatively affect your vehicle's Anti-Lock Brake System (ABS).

Tire care

For proper maintenance, safety, and maximum fuel economy, always maintain the recommended tire inflation pressures and stay within the load limits and weight distribution recommended for your vehicle.

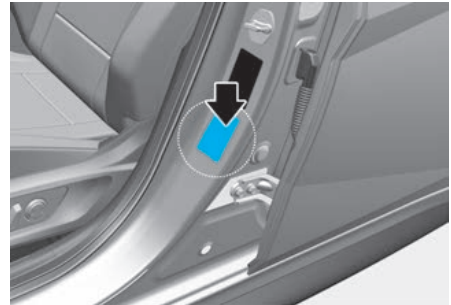

All specifications (sizes and pressures) can be found on a label attached to the driver's side center pillar.

Recommended cold tire inflation pressures

Check all tire pressures (including the spare) when the tires are cold. "Cold tires" mean the vehicle has not been driven for at least three hours or driven less than 1 mi. (1.6 km).

Warm tires normally exceed the recommended cold tire pressures by 4 to 6 psi (28 to 41 kPa). Do not release air from warm tires to adjust the pressure. The tires are under-inflated. For the recommended inflation pressure, refer to the "Tires and Wheels" section in chapter 10.



WARNING

- Recommended pressures must be maintained for the best ride, vehicle handling, and minimum tire wear.
 - Over-inflation or under-inflation can reduce tire life, adversely affect vehicle handling, and lead to sudden tire failure that may result in loss of vehicle control resulting in a collision.
 - Severe under-inflation may lead to severe heat build-up, causing blowouts, tread separation, and other tire failures that result in loss of vehicle control resulting in a collision. This risk is much higher on hot days and when driving for a long time at high speeds.
 - Under-inflation may cause excessive wear, poor handling, and reduced fuel economy. Wheel deformation is also possible. Keep your tire pressures at the proper levels. If a tire frequently needs refilling, have it inspected by an authorized HYUNDAI dealer.
 - Over-inflation produces a harsh ride, excessive wear at the center of the tire tread, and a greater possibility of damage from road hazards.
-

Check tire inflation pressure

Check your tires, including the spare tire, at least once a month.

How to check

Use a good quality tire pressure gauge to check the tire pressure. You cannot tell if your tires are properly inflated simply by looking at them. Radial tires may look properly inflated when they are under-inflated.

Remove the valve cap from the tire valve stem. Press the tire gauge firmly onto the valve to get a pressure measurement. If the cold tire inflation pressure matches the recommended pressure on the tire and loading information label, no further adjustment is necessary. If the pressure is low, add air until it reaches the recommended pressure.

Be sure to put the valve caps back on the valve stems. Without the valve cap, dirt or moisture may get into the valve core and cause air leakage. If a valve cap is missing, install a new one as soon as possible.

If you overfill the tire, release air by pushing on the metal stem in the center of the tire valve. Recheck the tire pressure with the tire gauge. Be sure to put the valve caps back on the valve stems. Without the valve cap, dirt or moisture may get into the valve core and cause air leakage. If a valve cap is missing, install a new one as soon as possible.

Tire rotation

To equalize tread wear, HYUNDAI recommends that the tires be rotated according to the maintenance schedule or sooner if irregular wear develops.

During rotation, check the tires for correct balance.

When rotating tires, check for uneven wear and damage. Abnormal wear is usually caused by incorrect tire pressure, improper wheel alignment, out-of-balance wheels, severe braking, or severe cornering. Look for bumps or bulges in the tread or side of the tire. Replace the tire if you find any of these conditions. Replace the tire if fabric or cord is visible. After rotation, be sure to bring the front and rear tire pressures to specification and check wheel nut torque (proper torque is 79.6-94.0 lbf.ft [11.0-13.0 kgf.m]).

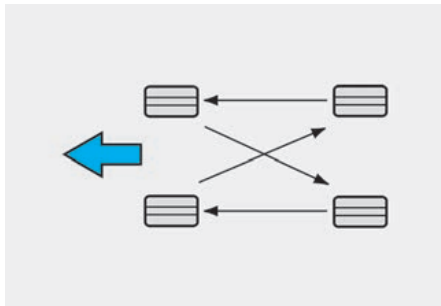

Disc brake pads should be inspected for wear whenever tires are rotated.

i Information

When installing an unsymmetrical tire, install the side marked "outside" facing out.

WARNING

- Do not use the compact spare tire for tire rotation.
- Do not mix bias ply and radial ply tires under any circumstances. This may cause unusual handling characteristics that may cause loss of vehicle control and result in a collision.

Wheel alignment and tire balance

The wheels on your vehicle were aligned and balanced carefully at the factory, and you may not need to have your wheels aligned again. If you notice unusual tire wear or your vehicle pulling to one side, the alignment may need to be adjusted.

If you notice your vehicle vibrating when driving on a smooth road, your wheels may need to be rebalanced.

NOTICE

Only use approved wheel weights or your vehicle's aluminum wheels may be damaged.

Tire replacement



If the tire is worn evenly, a tread wear indicator appears as a solid band across the tread. This shows there is less than 1/16 in. (1.6 mm) of tread left on the tire. Replace the tire when this happens.

Do not wait for the band to appear across the entire tread before replacing the tire.

WARNING

To reduce the risk of serious injury or death:

- Replace tires that are worn, show uneven wear, or are damaged. Worn tires may cause loss of braking effectiveness, steering control, and traction.
- Always replace tires with the same size as each tire that was originally supplied with this vehicle. Using tires and wheels other than the recommended sizes may cause unusual handling characteristics, poor vehicle control, or negatively affect your vehicle's Anti-Lock Brake System (ABS).

- When replacing tires (or wheels), it is recommended to replace the two front or two rear tires (or wheels) as a pair. Replacing just one tire may seriously affect your vehicle's handling.
- Tires degrade over time, even when they are not being used. Regardless of the remaining tread, HYUNDAI recommends that tires be replaced after six (6) years.
- Driving in hot climates or excessive loading may accelerate the tire aging process.

Compact spare tire replacement

 If equipped

A compact spare tire has a shorter tread life than a regular size tire. Replace it when you can see the tread wear indicator bars on the tire. The replacement compact spare tire should be the same size and design tire as the one provided with your vehicle and must be mounted on the same compact spare tire wheel. The compact spare tire is not designed to be mounted on a regular size wheel, and the compact spare tire wheel is not designed for mounting a regular size tire.

WARNING

The normal size tire should be repaired or replaced as soon as possible to avoid failure of the spare and loss of vehicle control resulting in a collision.

The compact spare tire is for emergency use only. Do not operate your vehicle over 50 mph (80 km/h) when using the compact spare tire.

Wheel replacement

When replacing the metal wheels for any reason, make sure the new wheels are equivalent to the original factory units in diameter, rim width, and offset.

Tire traction

Tire traction can be reduced if you drive on worn tires or the tires that are improperly inflated, or on slippery road surfaces. Replace the tires when tread wear indicators appear. To reduce the possibility of losing control, slow down whenever there is rain, snow, or ice on the road.

Tire maintenance

In addition to proper inflation, correct wheel alignment helps decrease the tire wear. If you find a tire is worn unevenly, have your dealer check the wheel alignment. When you have new tires installed, make sure they are balanced. This may increase ride comfort and tire life. Additionally, a tire must always be rebalanced if it is removed from the wheel.

Tire sidewall labeling

This information identifies and describes the fundamental characteristics of the tire and also provides the tire identification number (TIN) for safety standard certification. The TIN can be used to identify the tire in case of a recall.

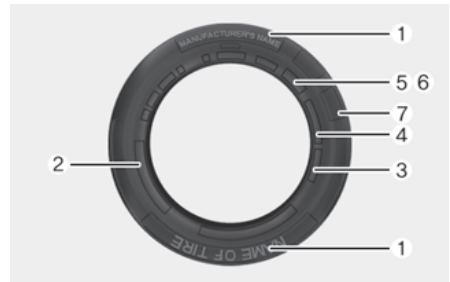

1. Manufacturer or brand name

Manufacturer or brand name is shown.

2. Tire size designation

A tire's sidewall is marked with a tire size designation. You need this information when selecting replacement tires for your vehicle. The following explains what the letters and numbers in the tire size designation mean.

Example tire size designation:

(These numbers are provided as an example only. Your tire size designator may vary depending on your vehicle.)

205/55R16 91H

205 - Tire width in millimeters.

55 - Aspect ratio. The tire's section height as a percentage of its width.

R - Tire construction code (Radial).

16 - Rim diameter in inches.

91 - Load Index, a numerical code associated with the maximum load the tire can carry.

H - Speed Rating Symbol. See the speed rating chart in this section for additional information.

Wheel size designation

Wheels are also marked with important information that you need if you ever have to replace one.

Example wheel size designation:

6.5J X 16

6.5 - Rim width in inches.

J - Rim contour designation.

16 - Rim diameter in inches.

Tire speed ratings

The chart below lists many of the different speed ratings currently being used for passenger vehicle tires. The speed rating is part of the tire size designation on the sidewall of the tire. This symbol corresponds to that tire's designed maximum safe operating speed.

| Speed Rating Symbol | Maximum Speed |
|---------------------|--------------------|
| S | 112 mph (180 km/h) |
| T | 118 mph (190 km/h) |
| H | 130 mph (210 km/h) |
| V | 149 mph (240 km/h) |
| W | 168 mph (270 km/h) |
| Y | 186 mph (300 km/h) |

3. Checking tire life (TIN: Tire Identification Number)

Any tires that are over six years old, based on the manufacturing date, (including the spare tire) must be replaced by new ones. You can find the manufacturing date on the tire sidewall (possibly on the inside of the wheel), displaying the DOT Code. The DOT Code is a series of numbers on a tire consisting of numbers and English letters. The manufacturing date is designated by the last four digits (characters) of the DOT code.

DOT: XXXX XXXX 0000

The front part of the DOT shows a plant code number, tire size, and tread pattern and the last four numbers indicate the week and year manufactured.

For example:

DOT XXXX XXXX 1423 represents that the tire was produced in the 14th week of 2023.

4. Tire ply composition and material

The number of layers or plies of rubber-coated fabric in the tire. Tire manufacturers also must indicate the materials in the tire, which include steel, nylon, polyester, and others. The letter "R" means radial ply construction. The letter "D" means diagonal or bias ply construction; and the letter "B" means belted-bias ply construction.

5. Maximum permissible inflation pressure

This number is the greatest amount of air pressure that should be put in the tire. Do not exceed the maximum permissible inflation pressure. Refer to the Tire and Loading Information label for recommended inflation pressure.

6. Maximum load rating

This number indicates the maximum load in kilograms and pounds that can be carried by the tire. When replacing the tires on the vehicle, always use a tire that has the same load rating as the factory installed tire.

7. DOT Tire Quality Grading (U.S. Vehicles)

The tires on your vehicle meet all U.S. Federal Safety Requirements. All tires are also graded for treadwear, traction, and temperature performance according to Department of Transportation (DOT) standards.

Uniform tire quality grading

Quality grades can be found where applicable on the tire sidewall between tread shoulder and maximum section width.

For example:

TREADWEAR 200

TRACTION AA

TEMPERATURE A

Tread wear

The tread wear grade is a comparative rating based on the wear rate of the tire when tested under controlled conditions on a specified government test course. For example, a tire graded 150 would wear one-and-a-half times (1½) as well on the government course as a tire graded 100.

The relative performance of tires depends upon the actual conditions of their use, however, and may depart significantly from the norm due to variations in driving habits, service practices, and differences in road characteristics and climate.

These grades are molded on the sidewalls of passenger vehicle tires. The tires available as standard or optional equipment on your vehicle may vary depending on the grade.

Traction - AA, A, B & C

The traction grades, from highest to lowest, are AA, A, B, and C. Those grades represent the tire's ability to stop on wet pavement as measured under controlled conditions on specified government test surfaces of asphalt and concrete. A tire marked C may have poor traction performance.

WARNING

The traction grade assigned to this tire is based on straight ahead braking traction tests, and does not include acceleration, cornering, hydroplaning, or peak traction characteristics.

Temperature - A, B & C

The temperature grades are A (the highest), B and C representing the tire's resistance to the generation of heat and its ability to dissipate heat when tested under controlled conditions on a specified indoor laboratory test wheel.

Sustained high temperature may cause the material of the tire to degenerate and reduce tire life, and excessive temperature may lead to sudden tire failure. The grade C corresponds to a level of performance that all passenger car tires must meet the Federal Motor Vehicle Safety Standard No. 109. Grades A and B represent higher levels of performance on the laboratory test wheel than the minimum required by law.



WARNING

The temperature grade for this tire is established for a tire that is properly inflated and not overloaded. Excessive speed, under-inflation, over-inflation, or excessive loading, either separately or in combination, may cause heat build-up and possible sudden tire failure.

Tire terminology and definitions

Air pressure

The amount of air inside the tire pressing outward on the tire. Air pressure is expressed in pounds per square inch (psi) or kilopascal (kPa).

Accessory weight

This means the combined weight of optional accessories. Some examples of optional accessories are automatic transmission, power seats, and air conditioning.

Aspect ratio

The relationship of a tire's height to its width.

Belt

A rubber coated layer of cords that is located between the plies and the tread. Cords may be made from steel or other reinforcing materials.

Bead

The tire bead contains steel wires wrapped by steel cords that hold the tire onto the rim.

Bias ply tire

A pneumatic tire in which the plies are laid at alternate angles less than 90 degrees to the centerline of the tread.

Cold tire pressure

The amount of air pressure in a tire, measured in pounds per square inch (psi) or kilopascals (kPa) before a tire has built up heat from driving.

Curb weight

This means the weight of a motor vehicle with standard and optional equipment including the maximum capacity of fuel, oil and coolant, but without passengers and cargo.

DOT markings

A code molded into the sidewall of a tire signifying that the tire is in compliance with the U.S. Department of Transportation motor vehicle safety standards. The DOT code includes the Tire Identification Number (TIN), an alphanumeric designator which can also identify the tire manufacturer, production plant, brand and date of production.

GVWR

Gross Vehicle Weight Rating

GAWR FRT

Gross Axle Weight Rating for the Front Axle.

GAWR RR

Gross Axle Weight Rating for the Rear axle.

Intended outboard sidewall

The side of an asymmetrical tire, that must always face outward when mounted on a vehicle.

Kilopascal (kPa)

The metric unit for air pressure.

Light Truck (LT) tire

A tire designated by its manufacturer as primarily intended for use on lightweight trucks or multipurpose passenger vehicles.

Load ratings

The maximum load that a tire is rated to carry for a given inflation pressure.

Load index

An assigned number ranging from 1 to 279 that corresponds to the load carrying capacity of a tire.

Maximum inflation pressure

The maximum air pressure to which a cold tire may be inflated. The maximum air pressure is molded onto the sidewall.

Maximum load rating

The load rating for a tire at the maximum permissible inflation pressure for that tire.

Maximum loaded vehicle weight

The sum of curb weight; accessory weight; vehicle capacity weight; and production options weight.

Normal occupant weight

The number of occupants a vehicle is designed to seat multiplied by 150 lbs. (68 kg).

Occupant distribution

Designated seating positions.

Outward facing sidewall

An asymmetrical tire has a particular side that faces outward when mounted on a vehicle. The outward facing sidewall bears white lettering or bears manufacturer, brand, and/or model name molding that is higher or deeper than the same moldings on the inner facing sidewall.

Passenger (P-Metric) tire

A tire used on passenger cars and some light duty trucks and multipurpose vehicles.

Ply

A layer of rubber-coated parallel cords.

Pneumatic tire

A mechanical device made of rubber, chemicals, fabric and steel or other materials, that, when mounted on an automotive wheel provides the traction and contains the gas or fluid that sustains the load.

Pneumatic options weight

The combined weight of installed regular production options weighing over 5 lb. (2.3 kg) in excess of the standard items which they replace, not previously considered in curb weight or accessory weight, including heavy duty breaks, ride levelers, roof rack, heavy duty battery, and special trim.

Recommended inflation pressure

Vehicle manufacturer's recommended tire inflation pressure as shown on the tire placard.

Radial ply tire

A pneumatic tire in which the ply cords that extend to the beads are laid at 90 degrees to the centerline of the tread.

Rim

A metal support for a tire and upon which the tire beads are seated.

Sidewall

The portion of a tire between the tread and the bead.

Speed rating

An alphanumeric code assigned to a tire indicating the maximum speed at which a tire can operate.

Traction

The friction between the tire and the road surface. The amount of grip provided.

Tread

The portion of a tire that comes into contact with the road.

Treadwear indicators

Narrow bands, sometimes called "wear bars", that show across the tread of a tire when only 1/16 in. of tread remains.

UTQGS

Uniform Tire Quality Grading Standards is a tire information system that provides consumers with ratings for a tire's traction, temperature and treadwear. Ratings are determined by tire manufacturers using government testing procedures. The ratings are molded into the sidewall of the tire.

Vehicle capacity weight

The number of designated seating positions multiplied by 150 lbs. (68 kg) plus the rated cargo and luggage load.

Vehicle maximum load on the tire

Load on an individual tire due to curb and accessory weight plus maximum occupant and cargo weight.

Vehicle normal load on the tire

Load on an individual tire that is determined by distributing to each axle its share of the curb weight, accessory weight, and normal occupant weight and dividing by 2.

Vehicle placard

A label permanently attached to a vehicle showing the original equipment tire size and recommended inflation pressure.

All season tires

HYUNDAI specifies all season tires on some models to provide good performance for use all year round, including snowy and icy road conditions. All season tires are identified by ALL SEASON and/or M+S (Mud and Snow) on the tire sidewall. Snow tires have better snow traction than all season tires and may be more appropriate in some areas.

Summer tires

HYUNDAI specifies summer tires on some models to provide superior performance on dry roads. Summer tire performance is substantially reduced in snow and ice. Summer tires do not have the tire traction rating M+S (Mud and Snow) on the tire side wall. If you plan to operate your vehicle in snowy or icy conditions, HYUNDAI recommends the use of snow tires or all season tires on all four wheels.

Snow tires

If you use snow tires, they should be the same size and have the same load capacity as the original tires. Snow tires should be installed on all four wheels. Otherwise, poor handling may result. Snow tires should carry 4 psi (28 kPa) more air pressure than the pressure recommended for the standard tires on the tire label located on the driver's side center pillar, or up to the maximum pressure shown on the tire sidewall, whichever is less. Do not drive faster than 75 mph (120 km/h) when your vehicle is equipped with snow tires.

Radial-ply tires

Radial-ply tires provide improved tread life, road hazard resistance and smoother high speed ride. The radial-ply tires used on this vehicle are of belted construction, and are selected to complement the ride and handling characteristics of your vehicle. Radial-ply tires have the same load carrying capacity, as bias-ply or bias belted tires of the same size, and use the same recommended inflation pressure. Mixing of radial-ply tires with bias-ply or bias belted tires is not recommended. Any combinations of radial-ply and bias-ply or bias belted tires when used on the same vehicle will seriously deteriorate vehicle handling. The best rule to follow is to use identical radial-ply tires as a pair for the front tires and rear tires.

Longer wearing tires can be more susceptible to irregular tread wear. It is very important to follow the tire rotation interval in this chapter to achieve the tread life potential of these tires. Cuts and punctures in radial-ply tires are repairable only in the tread area, because of sidewall flexing. Consult your tire dealer for radial-ply tire repairs.

WARNING

Do not mix bias ply and radial ply tires under any circumstances. This may cause unusual handling characteristics that may cause loss of vehicle control and result in a collision.

Low aspect ratio tires

The aspect ratio is lower than 50 on low aspect ratio tires.

Because low aspect ratio tires are optimized for handling and braking, their sidewall is a little stiffer than a standard tire. Also low aspect ratio tires tend to be wider and consequently have a greater contact patch with the road surface. In some instances they may generate more road noise compared with standard tires.

NOTICE

Low aspect wheels and tires are easily damaged. To reduce the risk of damage:

- When driving on rough roads, passing over a pothole, speed bump, manhole, or curb stone, drive the vehicle slowly not to damage the tires and wheels. Damage is not covered by your vehicle warranty.
 - Inspect the tire condition and pressure every 1,800 mi. (3,000 km).
 - It is difficult to visually inspect for tire damage with your eyes. If any damage is found, contact your authorized HYUNDAI dealer to replace the tire.
-

Fuses

Blade type



Cartridge type



Multi type

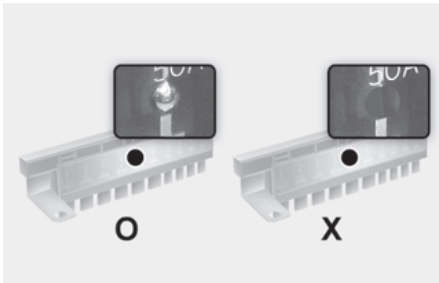

A vehicle's electrical system is protected from electrical overload damage by fuses.

This vehicle has 2 (or 3) fuse panels, one located in the driver's side panel bolster, the other in the engine compartment near the battery.

If any of your vehicle's lights, accessories, or controls do not work, check the appropriate circuit fuse. If a fuse has blown, the element inside the fuse is melted or broken.

If the electrical system does not work, first check the driver's side fuse panel. Before replacing a blown fuse, turn off the engine and all switches, and then disconnect the negative battery cable. Always replace a blown fuse with one of the same rating.

If the replacement fuse blows, this indicates an electrical problem. Avoid using the system involved and contact an authorized HYUNDAI dealer.

! WARNING

Never replace a fuse with anything but another fuse of the same rating.

- A higher capacity fuse may cause damage and possibly cause a fire.
- Do not install a wire or aluminum foil instead of the proper fuse - even as a temporary repair. It may cause extensive wiring damage and possibly a fire.

NOTICE

Do not use a screwdriver or any other metal object to remove fuses because it may cause a short circuit and damage the system.

Instrument panel fuse replacement



1. Turn off the vehicle.
2. Turn off all other switches.
3. Open the fuse panel cover.
4. Refer to the label on the inside of the fuse panel cover to locate the suspected fuse location.
5. Pull the suspected fuse straight out. Use the removal tool provided in the engine compartment fuse panel cover.

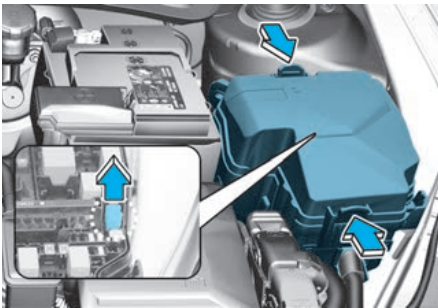

6. Check the removed fuse and replace it if it is blown. Spare fuses are provided in the engine compartment fuse panel.
7. Push in a new fuse of the same rating, and make sure it fits tightly in the clips. If it is not tight, contact an authorized HYUNDAI dealer.

In an emergency, if you do not have a spare fuse, use a fuse of the same rating from a circuit you may not need for operating the vehicle.

If the headlight, turn signal lights, tail lights, interior lamps does not work and the fuses are undamaged, contact an authorized HYUNDAI dealer.

Engine compartment panel fuse replacement

Blade fuse

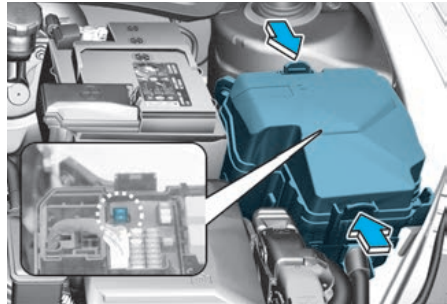

Cartridge fuse

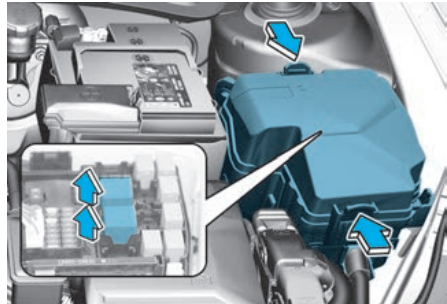

1. Turn off the vehicle.
2. Turn off all other switches.
3. Remove the fuse panel cover by pressing the tap and pulling up.
4. Check the removed fuse and replace it if it is blown. To remove or insert the fuse, use the removal tool in the engine compartment fuse panel.
5. Push in a new fuse of the same rating, and make sure it fits tightly in the clips. If it is not tight, contact an authorized HYUNDAI dealer.

NOTICE

Always securely install the fuse panel cover. Water may contact the fuse and cause an electrical failure.

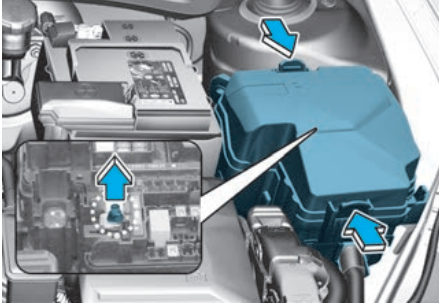
Multi fuse (Main fuse)

If the multi fuse or midi fuse is blown, contact an authorized HYUNDAI dealer.

Fuse/Relay panel description

Instrument panel fuse panel



Inside the fuse panel cover, you can find the label describing fuse names and ratings.

i Information

Not all fuse panel descriptions in this manual may be applicable to your vehicle. When you inspect the fuse panel on your vehicle, refer to the fuse panel label.

| | | | | | | | | |
|----------------------|---------------------|---------------|--------------|----------------------|-------------|-----------|-----------|----------|
| * HYBRID MODEL ONLY | | | 1 | 2 | 2 | 4 | 7 | |
| | | | MEMORY | AIR BAG | A/C | MODULE | MODULE | START |
| | | | E-CALL | * BATTERY MANAGEMENT | | CLUSTER | IBU | A/C |
| TRUNK OPEN | S/HEATER RR | P/WINDOW LH | MULTI MEDIA | 1 SPARE | LDC | FCA | MDPS | 6 MODULE |
| S/HEATER RR | SAFETY P/WINDOW DRV | P/WINDOW RH | BRAKE SWITCH | 1 IBU | 2 MODULE | 1 AIR BAG | 5 MODULE | 2 SPARE |
| SAFETY P/WINDOW PASS | AMP | HEATED MIRROR | DOOR LOCK | IAU | | 3 MODULE | A/BAG IND | WASHER |
| P/SEAT PASS | P/SEAT DRV | WIPER | 1 MODULE | SUN ROOF | USB CHARGER | IG1 | | 3 A/C |
| | | | | | | | | |
| | | | | | | | | |

USE THE DESIGNATED FUSE ONLY
 USE SOLO LOS FUSIBLES ESPECIFICADOS. P/NO: 91990-AA520
 UTILISEZ SEULEMENT LE FUSIBLE DÉSIGNÉS

Driver's side fuse panel

| Fuse Name | Fuse Rating | Circuit Protected |
|------------------------|-------------|--|
| MEMORY1 | 10A | Instrument Cluster, A/C Controller, A/C Control Module, DRV/PASS Folding Outside Mirror, Crash Pad Switch, Surround View Monitor |
| AIR BAG2 | 10A | SRS Control Module |
| MODULE4 | 10A | Lane Keeping Assist Unit (LINE), Crash Pad Switch, IBU, A/T Shift Lever Indicator, Front Console Switch, Surround View Monitor |
| MODULE7 | 7.5A | Rear Seat Warmer Control Module |
| START | 7.5A | Burglar Alarm Relay, Transaxle Range Switch, PCM/ECMIBU, E/R Junction Block (Start Relay) |
| CLUSTER | 7.5A | Instrument Cluster |
| IBU2 | 7.5A | IBU |
| A/C1 | 7.5A | E/R Junction Block (PTC Heater Relay, Blower Relay), A/C Control Module, A/C Controller |
| TRUNK | 10A | Trunk Lid Latch |
| S/HEATER FRT | 20A | Front Seat Warmer Control Module |
| P/WINDOW LH | 25A | Power Window Main Switch |
| MULTIMEDIA | 15A | Audio, A/V & Navigation Head Unit, DC-DC Converter (Smartstream G 2.0 Atkinson ISG only) |
| FCA | 10A | Forward Collision Avoidance Assist Unit |
| MDPS *1 | 7.5A | MDPS Unit |
| MODULE6 | 7.5A | IBU |
| S/HEATER RR | 20A | Rear Seat Warmer Control Module |
| SAFETY P/WINDOW DRV | 25A | Driver Safety Power Window Module |
| P/WINDOW RH | 25A | Power Window Main Switch, Passenger Power Window Switch |
| BRAKE SWITCH | 10A | Stop Light Switch, IBU |
| IBU1 | 15A | IBU |

*1 : MDPS (Motor Driven Power Steering) is the same as EPS (Electric Power Steering)

Driver's side fuse panel

| Fuse Name | Fuse Rating | Circuit Protected |
|----------------------|-------------|--|
| MODULE2 | 10A | E/R Junction Block (Power Outlet Relay), AMP, IBU, IAU, Audio, Power Outside Mirror Switch, DC-DC Converter (Smartstream G 2.0 Atkinson ISG only), A/V & Navigation Head Unit, Surround View Monitor |
| AIR BAG1 | 15A | SRS Control Module, Passenger Occupant Detection Sensor |
| MODULE5 | 10A | A/T Shift Lever Indicator, Front Wireless Charger, A/C Controller, Electro Chromic Mirror, A/C Control Module, Audio, A/V & Navigation Head Unit, AMP, DC-DC Converter (Smartstream G 2.0 Atkinson ISG only), Data Link Connector, Rear Seat Warmer Control Module, Front Seat Warmer Control Module |
| SAFETY P/WINDOW PASS | 25A | Passenger Safety Power Window Module |
| AMP | 25A | AMP, DC-DC Converter (Smartstream G 2.0 Atkinson ISG only) |
| HEATED MIRROR | 10A | DRV/PAS Outside Mirror Heated, A/C Control Module, A/C Controller, ECU (N Line only) |
| DOOR LOCK | 20A | Door Lock/Unlock Actuator |
| IAU | 10A | BLE Unit, IAU, Driver/Passenger Door NFC Module |
| MODULE3 | 7.5A | Sport Mode Switch, Stop Light Switch, IAU |
| A/BAG IND | 7.5A | Instrument Cluster, Overhead Console Lamp |
| WASHER | 15A | Multifunction Switch |
| P/SEATPASS | 30A | Power Seat |
| P/SEATDRV | 30A | Power Seat |
| WIPER | 10A | PCM/ECM, IBU |
| MODULE1 | 10A | Driver/Passenger Smart Key Outside Handle, Data Link Connector, Hazard Switch, Key Solenoid |
| SUNROOF | 20A | Sunroof Motor |
| USB CHARGER | 15A | Front USB Charger, Rear Console USB Charger |
| IG1 | 25A | PCB Block (Fuse - ABS3, ECU5, EOP2, TCU2) |

Engine compartment fuse panel

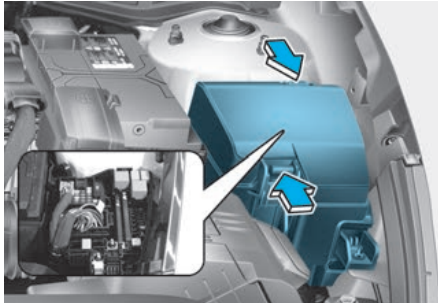

Inside the fuse panel cover, you can find the panel label describing fuse names and ratings.

i Information

Not all fuse panel descriptions in this manual may be applicable to your vehicle. When you inspect the fuse panel on your vehicle, refer to the fuse panel label.

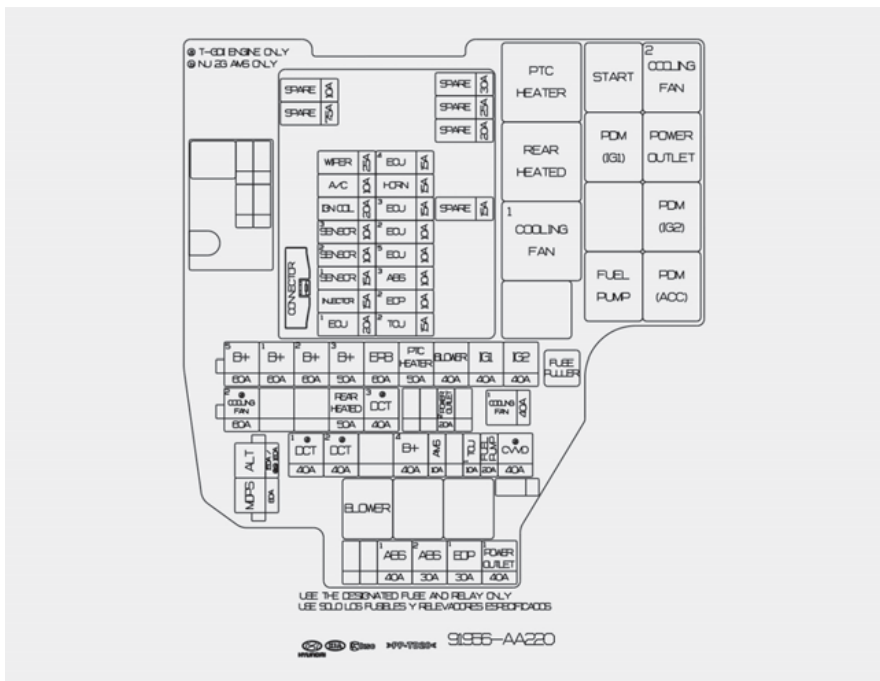

Engine compartment fuse panel

| Type | Fuse Name | Fuse Rating | Circuit Protected |
|--------------|--------------|-------------|---|
| MULTI FUSE-3 | ALT | 150A180A | [Smartstream G 2.0 Atkinson with AMS2] Alternator, (Fuse - ABS1, ABS2, EOP1, POWER OUTLET1) [Smartstream G 2.0 Atkinson & Smartstream G1.6 T-GDi without AMS2] Alternator, (Fuse - ABS1, ABS2, POWER OUTLET1) |
| | MDPS1 | 80A | MDPS Unit |
| MULTI FUSE-2 | COOLING FAN2 | 60A | [G4FP] Cooling Fan Controller |
| | DCT3 | 40A | [G4FP] SGA |
| | REAR HEATED | 50A | Rear Glass Heated |
| MULTI FUSE-1 | B+5 | 60A | PCB Block (Engine Control Relay, Fuse - ECU3, ECU4, HORN, WIPER, A/C) |
| | B+1 | 60A | ICU Junction Block (IPS2/IPS3/IPS5/IPS6/IPS7/IPS14) |
| | B+2 | 60A | ICU Junction Block (IPS1/IPS4/IPS8/IPS9/IPS10) |
| | B+3 | 50A | ICU Junction Block (Fuse - TRUNK, AMP, SAFETY P/WINDOW DRV, SAFETY P/WINDOW PASS, P/SEAT DRV, P/SEAT PASS, S/HEATER FRT, S/HEATER RR, Long Term Load Latch Relay) |
| | EPB | 60A | ESC Control Module |
| | PTC HEATER | 50A | PTC HEATER |
| | BLOWER | 40A | BLOWER Motor, Multipurpose Check Connector |
| | IG1 | 40A | E/R Junction Block (PDM (IG1/ACC) Relay), Ignition Switch |
| | IG2 | 40A | E/R Junction Block (PDM (IG2) Relay, Start Relay), Ignition Switch |

Engine compartment fuse panel

| Type | Fuse Name | Fuse Rating | Circuit Protected |
|---------------|---------------|--------------|--|
| FUSE | POWER OUTLET2 | 20A | Front Power Outlet |
| | COOLING FAN1 | 40A | Cooling Fan (Smartstream G 2.0 Atkinson only) |
| | DCT1 | 40A | [G4FP] TCM |
| | DCT2 | 40A | [G4FP] TCM |
| | B+4 | 40A | ICU Junction Block (Fuse - AIR BAG2, IBU1, BRAKE SWITCH, DOOR LOCK, IAU, MODULE1, SUNROOF, Power Window Relay) |
| | AMS | 10A | Battery Sensor |
| | TCU1 | 10A | [DCT] TCM |
| | FUEL PUMP | 20A | Fuel Pump Control Module (T-GDI), Fuel Pump Motor (NU MPI AKS) |
| | CVVD | 40A | [G4FP] CVVD Actuator |
| | ABS1 | 40A | ABS Control Module, ESC Control Module, Multipurpose Check Connector |
| | ABS2 | 30A | ABS Control Module, ESC Control Module, Multipurpose Check Connector |
| | EOP1 | 30A | Electronic Oil Pump (Smartstream G 2.0 Atkinson ISG only) |
| POWER OUTLET1 | 40A | P/OUTLET FRT | |

Engine compartment fuse panel

| Fuse Name | Fuse Rating | Circuit Protected |
|-----------|-------------|---|
| WIPER | 25A | Wiper Motor |
| ECU4 | 15A | PCM/ECM |
| A/C | 10A | [G4FM] A/C Compressor (Smartstream G 2.0 Atkinson only) |
| HORN | 15A | Horn |
| IGN COIL | 20A | Ignition Coil #1~#4 |
| ECU3 | 15A | PCM/ECM |
| SENSOR3 | 10A | E/R Junction Block (Fuel Pump Relay) |
| ECU2 | 10A | PCM/ECM (Smartstream G1.6 T-GDi only) |
| SENSOR2 | 10A | [G4NS] Variable Intake Solenoid Valve, Oil Pump Solenoid Valve, Oil Control Valve #1/#2, Canister Close Valve, Purge Control Solenoid Valve, PCB Block (A/C Relay), E/R Junction Block (Cooling Fan1/2 Relay), Oil Level Sensor [G4FP] Variable Oil Pump Solenoid, Oil Control Valve #1/#2, Purge Control Solenoid Valve, RCV Control Solenoid Valve, Canister Close Valve, Oil Level Sensor |
| ECU5 | 10A | CVVD Actuator (Smartstream G1.6 T-GDi only), ECM/PCM |
| SENSOR1 | 15A | Oxygen Sensor (UP/DOWN) |
| ABS3 | 10A | ABS Control Module, ESC Control Module, Multipurpose Check Connector |
| INJECTOR | 15A | [G4FM/G4FG/G4NA] Injector #1~#4 (Smartstream G 2.0 Atkinson only) |
| ECU1 | 20A | PCM/ECM |
| TCU2 | 15A | Transaxle Range Switch, [G4FP] TCM (Smartstream G1.6 T-GDi & DCT only) |

Light bulbs

Contact an authorized HYUNDAI dealer to replace most vehicle light bulbs. It is difficult to replace vehicle light bulbs because other parts of the vehicle must be removed before you can get to the bulb. This is especially true for removing the headlight assembly to get to the bulb(s).

Removing/installing the headlight assembly may result in damage to the vehicle.

WARNING

- Prior to replacing a light bulb, depress the brake pedal, shift to P (Park), apply the parking brake, move the ignition switch to the LOCK/OFF position, and take the key with you when leaving the vehicle to avoid sudden movement of the vehicle and to prevent possible electric shock.
- Be aware the bulbs may be hot and may burn your fingers.
- When the bulb is disconnected or the lamp connector is removed while the lamp is operating normally, the fuse box electronics may recognize the lamp as a malfunction. Therefore, a fault record for the lamp may remain in the Diagnostic Trouble Code (DTC) recorded in the fuse box.

NOTICE

- Be sure to replace the burned-out bulb with one of the same wattage to prevent damage to the fuse or electrical wiring system.
- To prevent damage, do not clean the headlight lens with chemical solvents or strong detergents.

i Information

The headlight and tail light lenses could appear to have condensation inside if the vehicle is washed after driving or if the vehicle is driven in wet weather. This condition is caused by a higher temperature inside the light and a cooler outside temperature. Moisture that condenses in the light is removed after driving with the light on. If the moisture is not removed, contact an authorized HYUNDAI dealer.

i Information

Adjust the headlight aim after an accident or the headlight is replaced.

Headlight, parking light, Daytime Running Light, turn signal light, side marker replacement

Type A

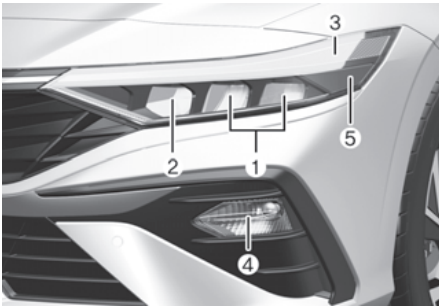

Type B

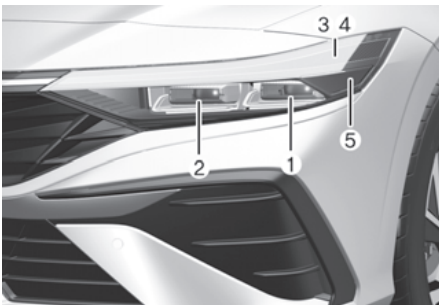

- (1) Headlight (Low)
- (2) Headlight (High)
- (3) Daytime running light (DRL)/Parking light
- (4) Turn signal light
- (5) Side marker

Headlight/Daytime running light (DRL)/Parking light/Turn signal light/Side marker (LED type)

If the LED light does not operate, contact an authorized HYUNDAI dealer for replacement.

The LED light cannot be replaced as a single unit. A skilled technician should check or repair the LED light, for it may damage related parts of the vehicle.

Turn signal light (Bulb type, for A type)

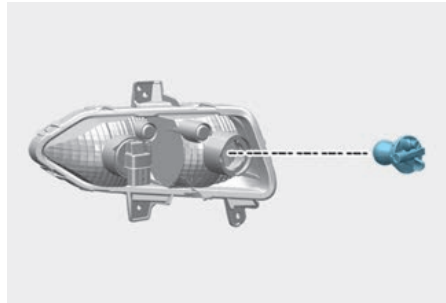

1. Turn off the engine.
2. Open the hood.
3. Remove the socket from the assembly by turning the socket counterclockwise until the tabs on the socket align with the slots on the assembly.
4. Remove the bulb from the socket by pushing it in and rotating it counterclockwise until the tabs on the bulb align with the slots in the socket. Pull the bulb out of the socket.
5. Insert a new bulb by inserting it into the socket and rotating it until it locks into place.
6. Install the socket in the assembly by aligning the tabs on the socket with the slots in the assembly.
7. Push the socket into the assembly and turn the socket clockwise.
8. Reinstall the light assembly to the body of the vehicle.

Side repeater light replacement

 if equipped



If the LED light (1) does not operate, contact an authorized HYUNDAI dealer for replacement.

The LED light cannot be replaced as a single unit. A skilled technician should check or repair the LED light, for it may damage related parts of the vehicle.

Rear combination light replacement

Type A

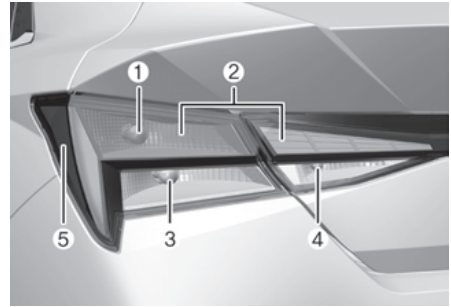

Type B

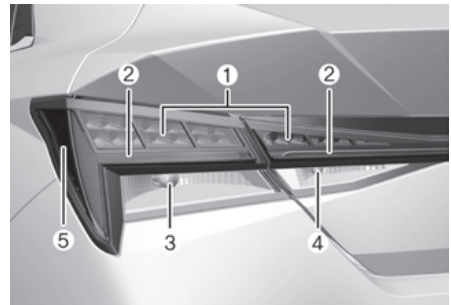

- (1) Stop light
- (2) Tail light
- (3) Turn signal light
- (4) Reverse light
- (5) Rear side marker

Tail light/Stop light/Turn signal light/Side marker (Outer lamp) (Bulb type)

1. Turn off the engine.
2. Open the trunk lid.
3. Remove the service cover by pulling it out.



4. Loosen the assembly retaining screws with a cross-tip screwdriver.

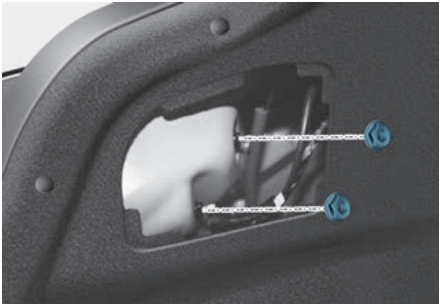

5. Remove the rear combination light assembly from the body of the vehicle.



6. Remove the socket from the assembly by turning the socket counterclockwise until the tabs on the socket align with the slots on the assembly.
7. Remove the bulb from the socket by pushing it in and rotating it counterclockwise until the tabs on the bulb align with the slots in the socket. Pull the bulb out of the socket.

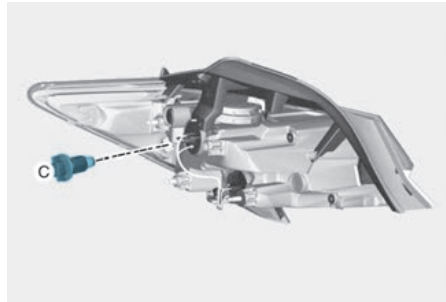
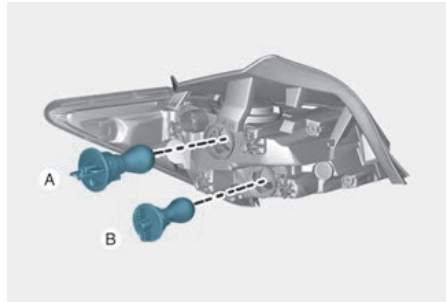

[A] Tail/Stop light
[B] Turn signal light
[C] Rear side marker

8. Insert a new bulb by inserting it into the socket and rotating it until it locks into place.
9. Install the socket in the assembly by aligning the tabs on the socket with the slots in the assembly. Push the socket into the assembly and turn the socket clockwise.
10. Reinstall the light assembly to the body of the vehicle.

Tail light/Stop light (Inner lamp) (Bulb type)

1. Turn off the engine.
2. Open the trunk.
3. Loosen the retaining screw of the trunk lid cover and then remove the cover.
4. Remove the socket from the assembly by turning the socket counterclockwise until the tabs on the socket align with the slots on the assembly. Pull the bulb out of the socket.

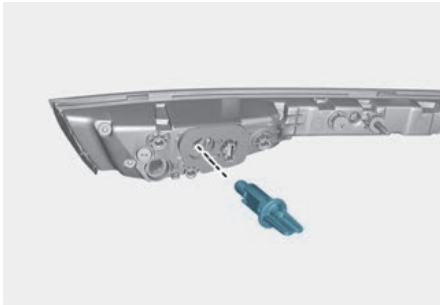

5. Insert a new bulb by inserting it into the socket.
6. Reinstall the trunk lid cover by pushing in the screw.

Reverse light (Inner lamp) (Bulb type)

1. Disconnect the connector and then remove the nuts by turning the nuts counter clockwise.
2. Take the light assembly out.
3. Remove the socket from the assembly by turning the socket counterclockwise until the tabs on the socket align with the slots on the assembly. Pull the bulb out of the socket.

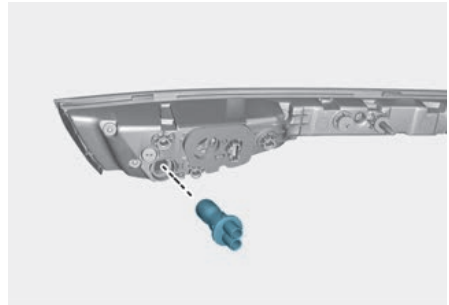

4. Insert a new bulb by inserting it into the socket.
5. Install the light assembly to the trunk.
6. Reinstall the trunk lid cover by pushing in the screw.

Stop/Tail light/Rear side marker (LED type)

If the LED light does not operate, contact an authorized HYUNDAI dealer for replacement.

The LED light cannot be replaced as a single unit. A skilled technician should check or repair the LED light, for it may damage related parts of the vehicle.

High mounted stop light replacement

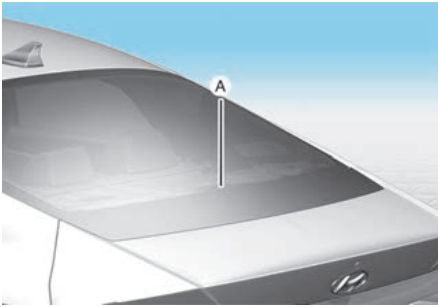

[A] High mounted stop light

1. Turn off the engine.
2. Open the trunk.
3. Remove the socket by turning it counterclockwise until the tabs on the socket align with the slots.
4. Remove the bulb from the socket by pushing it in and rotating it counterclockwise until the tabs on the bulb align with the slots in the socket. Pull the bulb out of the socket.
5. Insert a new bulb by inserting it into the socket and rotating it until it locks into place.
6. Install the socket in the assembly by aligning the tabs on the socket with the slots in the assembly. Push the socket into the assembly and turn the socket clockwise.

License plate light bulb replacement

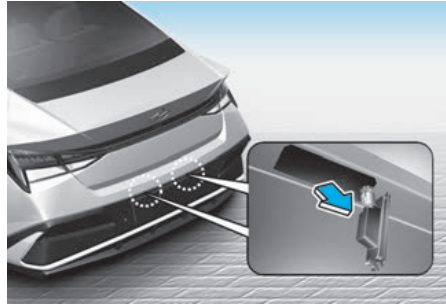

1. Turn off the engine.
2. Using a flat-blade screwdriver gently pry the lens cover from the lamp housing.
3. Remove the bulb by pulling it straight out.
4. Install a new bulb.
5. Reinstall in the reverse order.

Interior light replacement

Map lamp, room lamp, sunvisor lamp, and trunk room lamp (Bulb type)

Map lamp

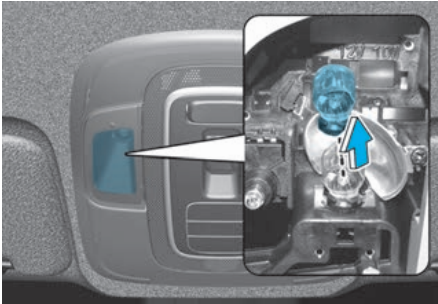

Room lamp

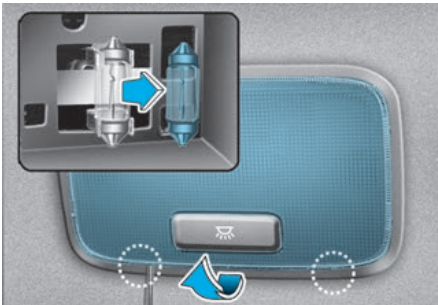

Sunvisor lamp

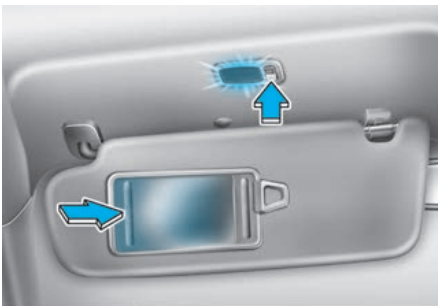

Trunk room lamp



1. Turn off the engine.
2. Using a flat-blade screwdriver, gently pry the lens from the interior lamp housing.
3. Remove the bulb by pulling it straight out.
4. Install a new bulb in the socket.
5. Align the lens tabs with the interior lamp housing notches and snap the lens into place.

⚠ WARNING

Prior to working on the Interior Lights, ensure that the "OFF" button is depressed to avoid burning your fingers or receiving an electric shock.

NOTICE

Be careful not to damage the cover, tab, and plastic housing.

Mood lamp (LED type)

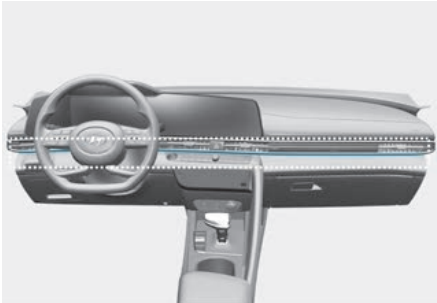

If the LED light does not operate, contact an authorized HYUNDAI dealer for replacement.

The LED light cannot be replaced as a single unit. A skilled technician should check or repair the LED light, for it may damage related parts of the vehicle.

Appearance care

Exterior care

Exterior general caution

It is very important to follow the label directions when using any chemical cleaner or polish. Read all warning and caution statements that appear on the label.

Finish maintenance

Washing

To help protect your vehicle's finish from rust and deterioration, wash it thoroughly and frequently at least once a month with lukewarm or cold water.

If you use your vehicle for off-road driving, wash it after each off-road trip. Pay special attention to the removal of any accumulation of salt, dirt, mud, and other foreign materials. Make sure the drain holes in the lower edges of the doors and rocker panels are kept clear and clean.

Insects, tar, tree sap, bird droppings, industrial pollution, and similar deposits may damage your vehicle's finish if not removed immediately.

Even prompt washing with plain water may not completely remove all these deposits. Use a mild soap, safe for use on painted surfaces.

After washing, rinse the vehicle thoroughly with lukewarm or cold water. Do not allow soap to dry on the finish.

NOTICE

High pressure water may damage front and rear cameras, sensors, vehicle trim, and boots (rubber or plastic covers) or connectors.

⚠ WARNING

After washing the vehicle, dry the brakes by applying them lightly while maintaining a slow forward speed.

NOTICE

- Do not use strong soap, chemical detergents, or hot water, and do not wash the vehicle in direct sunlight or when the body of the vehicle is warm.
- To prevent damage to the plastic parts, do not clean with chemical solvents or strong detergents.

NOTICE

- Water washing in the engine compartment including high pressure water washing may cause the failure of electrical circuits located in the engine compartment.
- Never allow water or other liquids to come in contact with electrical/electronic components inside the vehicle to prevent damage.

NOTICE

Matte paint finish vehicle (if equipped)
To prevent damage the matte finish:

- Do not go through an automatic car wash with rotating brushes.
- Avoid using a steam cleaner. High temperature steam may leave stains that are difficult to remove.
- Use a soft cloth (e.g. microfiber towel or sponge) when washing your vehicle and dry with a microfiber towel. When you hand wash your vehicle, do not use a cleaner that finishes with wax. If the vehicle surface is too dirty (sand, dirt, dust, contaminant, etc.), clean the surface with water before washing the vehicle.

Waxing

A good coat of wax helps protect your paint from contaminants.

Wax the vehicle when water no longer beads on the paint.

Always wash and dry the vehicle before waxing. Use a good quality liquid or paste wax, and follow the manufacturer's instructions. Wax all metal trim to protect it and to maintain its luster.

Removing oil, tar, and similar materials with a spot remover usually strips the wax from the finish. Be sure to re-wax these areas even if the rest of the vehicle does not yet need waxing.

NOTICE

- Do not wipe dust or dirt off the body with a dry cloth to prevent scratching the finish.
- Do not use steel wool, abrasive cleaners, or strong detergents containing highly alkaline or caustic agents on chrome-plated or anodized aluminum parts to prevent discoloration or paint deterioration.

NOTICE

Matte paint finish vehicle (if equipped)

Do not use any polish protector such as detergent, abrasive, or polish. If wax is applied, remove the wax immediately using a silicone remover. If any tar or tar contaminant is on the surface, use a tar remover to clean.

Be careful not to apply too much pressure on the painted area.

Finish damage repair

Deep scratches or stone chips on the painted surface must be repaired promptly. Exposed metal quickly rusts and may develop into a major repair expense.

i Information

If your vehicle is damaged and requires any metal repair or replacement, make sure the body shop applies anti-corrosion materials to the parts repaired or replaced.

NOTICE

Matte paint finish vehicle (if equipped)

It is impossible to modify only repaint the damaged area. The whole part must be repainted as necessary. If the vehicle is damaged and painting is required, contact an authorized HYUNDAI dealer.

Bright-metal maintenance

- To remove road tar and insects, use a tar remover, not a scraper or other sharp object.
- To protect the surfaces of bright metal parts from corrosion, apply a coating of wax or chrome preservative and rub to a high luster.
- During winter weather or in coastal areas, cover the bright metal parts with a heavier coating of wax or preservative. If necessary, coat the parts with non-corrosive petroleum jelly or other protective compound.

Underbody maintenance

Corrosive materials used for ice and snow removal and dust control may collect on the underbody. If these materials are not removed, accelerated rusting may occur on underbody parts such as fuel lines, frame, floor pan, and exhaust system, even though they have been treated with rust protection.

Thoroughly flush the vehicle underbody and wheel openings with lukewarm or cold water once a month, after off-road driving and at the end of each winter. Pay special attention to these areas because it is difficult to see all the mud and dirt. It does more harm than good to wet down the road grime without removing it. The lower edges of doors, rocker panels, and frame members have drain holes that must not be allowed to clog with dirt. Trapped water in these areas may cause rusting.

Aluminum wheel maintenance

The aluminum wheels are coated with a clear protective finish.

NOTICE

- Do not use abrasive cleaner, polishing compound, solvent, or wire brushes on aluminum wheels.
- Use only a mild soap or neutral detergent, and rinse thoroughly with water. Also, clean the wheels after driving on salted roads.
- Do not wash the wheels with high-speed car wash brushes.
- Do not use any cleaners containing acid or alkaline detergents.

Corrosion protection

Protecting your vehicle from corrosion

By using the most advanced design and construction practices to combat corrosion, HYUNDAI produces vehicles of the highest quality. However, this is only part of the job. To achieve the long-term corrosion resistance your vehicle can deliver, the owner's cooperation and assistance are also required.

Common causes of corrosion

The most common causes of corrosion on your vehicle are:

- Road salt, dirt, and moisture that is allowed to accumulate underneath the vehicle.
- Removal of paint or protective coatings by stones, gravel, abrasion, minor scrapes, and dents that leave unprotected metal exposed to corrosion

High-corrosion areas

If you live in an area where your vehicle is regularly exposed to corrosive materials, corrosion protection is particularly important. Some of the common causes of accelerated corrosion are road salts, dust control chemicals, ocean air, and industrial pollution.

Moisture breeds corrosion

Moisture creates the conditions in which corrosion is most likely to occur. For example, corrosion is accelerated by high humidity, particularly when temperatures are just above freezing. In such conditions, the corrosive material is kept in contact with the vehicle surfaces by moisture that is slow to evaporate.

Mud is particularly corrosive because it is slow to dry and holds moisture in contact with the vehicle. Although the mud appears to be dry, it can still retain moisture and promote corrosion.

High temperatures may also accelerate corrosion of parts that are not properly ventilated so the moisture can be dispersed. For all these reasons, it is particularly important to keep your vehicle clean and free of mud or accumulation of other materials. This applies not only to the visible surfaces but particularly to the underside of the vehicle.

To help prevent corrosion

Keep your vehicle clean

The best way to prevent corrosion is to keep your vehicle clean and free of corrosive materials. Attention to the underside of the vehicle is particularly important.

- If you live in a high-corrosion area - where road salts are used, near the ocean, areas with industrial pollution, acid rain, and the like, take extra care to prevent corrosion. In winter, hose off the underside of your vehicle at least once a month and be sure to clean the underside thoroughly when winter is over.
- When cleaning underneath the vehicle, pay particular attention to the components under the fenders and other areas that are hidden from view. Do a thorough job. Just dampening the accumulated mud rather than washing it away may accelerate corrosion rather than prevent it. Water under high pressure and steam are particularly effective in removing accumulated mud and corrosive materials.
- When cleaning lower door panels, rocker panels, and frame members, make sure that drain holes are kept open so that moisture can escape and not be trapped inside to accelerate corrosion.

Keep your garage dry

Do not park your vehicle in a damp, poorly ventilated garage. This creates a favorable environment for corrosion.

This is particularly true if you wash your vehicle in the garage or drive it into the garage when it is still wet or covered with snow, ice, or mud. Even a heated garage may contribute to corrosion unless it is well ventilated so moisture is dispersed.

Keep paint and trim in good condition

Scratches or chips in the finish must be covered with "touch-up" paint as soon as possible to reduce the possibility of corrosion. If bare metal is showing through, the attention of a qualified body and paint shop is recommended.

Bird droppings are highly corrosive and may damage painted surfaces in just a few hours. Always remove bird droppings as soon as possible.

Interior care

Interior general precautions

Prevent caustic solutions such as perfume and cosmetic oil, from contacting the interior parts because they may cause damage or discoloration. If they do contact the interior parts, wipe them off immediately. Refer to the instructions for the proper way to clean vehicle interior surfaces.

NOTICE

- Never allow water or other liquids to come in contact with electrical/electronic components inside the vehicle because this may damage them.
 - When cleaning leather products (steering wheel, seats, etc.), use neutral detergents or low alcohol content solutions. If you use high alcohol content solutions or acid/alkaline detergents, the color of the leather may fade or the surface may get stripped off.
-

Cleaning the upholstery and interior trim

Vehicle interior surfaces

+ if equipped

Remove dust and loose dirt from interior surfaces with a whisk broom or a vacuum cleaner.

If necessary, clean interior surfaces with a mixture of warm water and mild non-detergent cleaner (test all cleaners on a concealed area before use).

Fabric

+ if equipped

Remove dust and loose dirt from fabric with a whisk broom or vacuum cleaner. Clean with a mild soap solution recommended for upholstery or carpets. Remove fresh spots immediately with a fabric spot cleaner. If you do not pay attention to fresh spots immediately, the fabric may be stained and its color may be affected. Also, its fire-resistant properties may be reduced if the material is not properly maintained.

NOTICE

Using anything but recommended cleaners and procedures may affect the fabric's appearance and fire-resistant properties.

Leather

+ if equipped

- Features of seat leather
 - Leather is made from the outer skin of an animal, which goes through a special process to be available for use. Because it is a natural product, each part differs in thickness or density.
 - Wrinkles may appear as a natural result of stretching and shrinking depending on the temperature and humidity.
 - The seat is made of stretchable fabric to improve comfort.
 - The parts contacting the body are curved and the side supporting area is high which provides driving comfort and stability.
 - Wrinkles may appear naturally from usage. It is not a fault of the products.

NOTICE

- Wrinkles or abrasions that appear naturally from usage are not covered by warranty.
- Belts with metallic accessories, zippers, or keys inside the back pocket may damage the seat fabric.
- Be sure not to wet the seat. It may change the nature of natural leather.
- Jeans or clothes that could bleach may contaminate the surface of the seat covering fabric.
- Caring for the leather seats
 - Vacuum the seat periodically to remove dust and sand on the seat. It prevents abrasion or damage of the leather and maintain its quality.
 - Wipe the natural leather seat cover often with a dry or soft cloth.

- Use of proper leather protector may prevent abrasion of the cover and helps maintain the color. Be sure to read the instructions and consult a specialist when using leather coating or protective agent.
 - Light colored (beige, cream beige) leather may be easily contaminated and the stains may be noticeable.
 - Avoid wiping with a wet cloth. It may cause the surface to crack.
 - **Cleaning the leather seats**
 - Remove all spills instantly.
 - For Cosmetic products (sunscreen, foundation, etc.)

Apply cleansing cream on a cloth and wipe the contaminated spot. Wipe off the cream with a damp loth and then wipe with a dry cloth.
 - For Beverages (coffee, soft drink, etc.)

Apply a small amount of neutral detergent and wipe until it does not smear.
 - For oil
Remove oil instantly with an absorbable cloth and wipe with stain remover used only for natural leather.
 - For chewing gum
Harden the gum with ice and remove it gradually.
-

Cleaning the seat belt webbing

Clean the belt webbing with any mild soap solution recommended for cleaning upholstery or carpet. Follow the instructions provided with the soap.

WARNING

Do not bleach or re-dye the webbing because this may weaken the seat belt.

Cleaning the interior window glass

If the interior glass surfaces need to be cleaned, use a glass cleaner. Follow the directions on the glass cleaner container.

NOTICE

Do not scrape or scratch the inside of the rear window. This may result in damage to the rear window defroster grid.

Emission control system

The emission control system of your vehicle is covered by a written limited warranty. Please see the warranty information contained in the Owner's Handbook & Warranty Information booklet in your vehicle.

Your vehicle is equipped with an emission control system to meet all applicable emission regulations. There are three emission control systems, as follows:

- (1) Crankcase emission control system
- (2) Evaporative emission control system
- (3) Exhaust emission control system

In order to ensure the proper function of the emission control systems, it is recommended that you have your vehicle inspected and maintained by an authorized HYUNDAI dealer in accordance with the maintenance schedule in this manual.

NOTICE

For the Inspection and Maintenance Test (with Electronic Stability Control (ESC) system)

- To prevent the vehicle from misfiring during dynamometer testing, turn the Electronic Stability Control (ESC) system off by pressing the ESC button (ESC OFF light illuminated).
- After dynamometer testing is completed, turn the ESC system back on by pressing the ESC button again.

1. Crankcase emission control system

The positive crankcase ventilation system is employed to prevent air pollution caused by blow-by gases being emitted from the crankcase. This system supplies fresh filtered air to the crankcase through the air intake hose. Inside the crankcase, the fresh air mixes with blow-by gases, which then pass through the PCV valve into the induction system.

2. Evaporative emission control system including onboard refueling vapor recovery (ORVR)

The Evaporative Emission Control System is designed to prevent fuel vapors from escaping into the atmosphere. The ORVR system is designed to allow the vapors from the fuel tank to be loaded into a canister while refueling at the gas station, preventing the escape of fuel vapors into the atmosphere.

Canister

Fuel vapors generated inside the fuel tank are absorbed and stored in the onboard canister. When the engine is running, the fuel vapors absorbed in the canister are drawn into the surge tank through the purge control solenoid valve.

Purge Control Solenoid Valve (PCSV)

The purge control solenoid valve is controlled by the Engine Control Module (ECM). When the engine coolant temperature is low during idling, the PCSV closes so that evaporated fuel is not taken into the engine. After the engine warms up during ordinary driving, the PCSV opens to introduce evaporated fuel to the engine.

3. Exhaust emission control system

The Exhaust Emission Control System controls exhaust emissions while maintaining good vehicle performance.

When the engine starts or fails to start, excessive attempts to restart the engine may cause damage to the emission system.

Engine exhaust (carbon monoxide) precautions

- Carbon monoxide is present with other exhaust fumes. If you smell exhaust fumes in your vehicle, drive with all the windows fully open. Have your vehicle inspected and repaired immediately.
- Do not operate the engine in confined or closed areas (such as garages) any more than what is necessary to move the vehicle in or out of the area.
- When the vehicle is stopped in an open area for more than a short time with the engine running, adjust the ventilation system (as needed) to draw outside air into the vehicle.
- Never sit in a parked or stopped vehicle for an extended time with the engine running.
- When the engine stalls or fails to start, excessive attempts to restart the engine may cause damage to the emission control system.

For more information, refer to "Driving your vehicle" at the beginning of chapter 6.

WARNING

Engine exhaust gases contain carbon monoxide (CO). Though colorless and odorless, it is dangerous and could be lethal if inhaled. Follow the instructions on this page to avoid CO poisoning.

Operating precautions for catalytic converters

 If equipped

WARNING

The exhaust system and catalytic system are very hot while the engine is running or immediately after the engine is turned off. To avoid serious injury or death:

- Do not park, idle, or drive the vehicle over or near flammable objects, such as grass, vegetation, paper, leaves, etc. A hot exhaust system may ignite flammable items under your vehicle.
- Keep away from the exhaust system and catalytic converter or you may get burned.

Also, do not remove the heat sink around the exhaust system, do not seal the bottom of the vehicle, and do not coat the vehicle for corrosion control. It may present a fire risk under certain conditions.

Your vehicle is equipped with a catalytic converter emission control device.

NOTICE

To prevent damage to the catalytic converter and to your vehicle, take the following precautions:

- Use only UNLEADED FUEL for gasoline engines.
- Do not operate the vehicle when there are signs of engine malfunction, such as misfire or a noticeable loss of performance.
- Do not misuse or abuse the engine. Examples of misuse are coasting with the engine off and descending steep grades in gear with the engine off.
- Do not operate the engine at high idle speed for extended an extended period of time (5 minutes or more).

- Do not modify or tamper with any part of the engine or emission control system. Have all inspections and adjustments made by an authorized HYUNDAI dealer.
- Avoid driving with an extremely low fuel level.
Running out of fuel may cause the engine to misfire, damaging the catalytic converter.

Failure to follow these precautions may void your vehicle warranty.

Fuel requirements

Gasoline engine

Unleaded

Your new vehicle is designed to perform optimally with unleaded fuel having an octane number $((R+M)/2)$ of 87 (Research Octane Number 91) or higher.

Your new vehicle is designed to obtain maximum performance with UNLEADED FUEL, as well as minimize exhaust emissions and spark plug fouling.

Gasoline containing ethanol and methanol

Gasohol, a mixture of gasoline and ethanol (also known as grain alcohol) are being marketed along with or instead of leaded or unleaded gasoline. For example, "E15" is a gasohol comprised of 15 % ethanol and 85 % gasoline.

Do not use gasohol containing more than 15 % ethanol, and do not use gasoline or gasohol containing any methanol. Do not use gasohol containing more than 15 % ethanol, and do not use gasoline or gasohol containing any methanol. Never use leaded fuel or leaded gasohol. Use of these fuels may damage the fuel system, engine control system, and emission control system.

Discontinue using gasohol of any kind if problems occur. "E85" fuel is an alternative fuel comprised of 85 % ethanol and 15 % gasoline, and is manufactured exclusively for use in Flexible Fuel Vehicles. "E85" is not compatible with your vehicle. Use of "E85" may result in poor engine performance and damage to your vehicle's engine and fuel system.

NOTICE

Damage to the fuel system or performance issues caused by the use of these fuels may not be covered by your New Vehicle Limited Warranty.

Using fuel additives (except detergent fuel additives)

Using fuel additives such as:

- Silicone fuel additive
- Ferrocene (iron-based) fuel additive
- Other metallic-based fuel additives

May result in cylinder misfire, poor acceleration, engine stalling, damage to the catalyst, or abnormal corrosion, and may cause damage to the engine resulting in a reduction in the overall life of the powertrain.

- The Malfunction Indicator Lamp (MIL) may illuminate.

NOTICE

Damage to the fuel system or performance issues caused by the use of these fuel additives may not be covered by your New Vehicle Limited Warranty.

Gasoline containing MMT

Some gasoline contains harmful manganese-based fuel additives such as MMT (Methylcyclopentadienyl Manganese Tricarbonyl).

HYUNDAI does not recommend the use of gasoline containing MMT.

This type of fuel can reduce vehicle performance and affect your emission control system.

The malfunction indicator lamp on the cluster may come on.

Detergent fuel additives

HYUNDAI recommends that you use good quality gasolines treated with detergent additives such as TOP TIER Detergent Gasoline, which help prevent deposit formation in the engine. These gasolines will help the engine run cleaner and enhance performance of the Emission Control System. For more information on TOP TIER Detergent Gasoline, go to the website (www.toptiergas.com).

For customers who do not use TOP Tier Detergent Gasoline regularly, and have problems starting or the engine does not run smoothly, detergent-based fuel additives that you can purchase separately may be added to the gasoline. If TOP TIER Detergent Gasoline is not available, one bottle of additive added to the fuel tank according to the maintenance schedule is recommended (refer to the Owner maintenance schedule in this chapter).

Additives are available from your authorized HYUNDAI dealer along with information on how to use them.

NOTICE

Never add any fuel system cleaning agents or other additives to the fuel tank other than HYUNDAI fuel additives to prevent damage to the engine and engine components.

Contact an authorized HYUNDAI dealer for additional information.

California perchlorate notice

Notice to California Vehicle Dismantlers:

The airbag module, safety belt pretensioners, and remote batteries must be disposed of according to Title 22

California Code of Regulations Section 67384.10 (a). Special handling may be necessary. See:

www.dtsc.ca.gov/hazardouswaste/perchlorate. Contact an authorized HYUNDAI dealer for handling and disposal.

10. Vehicle information, reporting safety defects, and consumer information

| | |
|--|-------|
| Dimensions | 10-2 |
| Engine specification | 10-3 |
| Bulb wattage..... | 10-4 |
| Tires and Wheels..... | 10-6 |
| Air conditioning system | 10-7 |
| Volume and weight | 10-7 |
| Recommended lubricants and capacities | 10-8 |
| Recommended SAE viscosity number | 10-9 |
| Vehicle Identification Number (VIN)..... | 10-10 |
| Vehicle certification label | 10-10 |
| Tire specification and pressure label | 10-10 |
| Engine number | 10-11 |
| Refrigerant label | 10-11 |
| Air conditioner compressor label | 10-11 |
| Fuel label | 10-12 |
| Operation in foreign countries | 10-13 |
| Hyundai vehicle owner privacy policy | 10-14 |
| Vehicle data collection and event data recorders | 10-15 |
| Reporting safety defects..... | 10-16 |
| FCC statement | 10-17 |
| Consumer information | 10-18 |
| Open source software notice | 10-19 |

Dimensions

| Items | | in. (mm) |
|----------------|-----------|---------------|
| Overall length | | 185.4 (4,710) |
| Overall width | | 72 (1,825) |
| Overall height | | 55.7 (1,415) |
| Front tread | 195/65R15 | 62.7 (1,593) |
| | 205/55R16 | 62.4 (1,585) |
| | 225/45R17 | 62.2 (1,579) |
| | 235/40R18 | 61.7 (1,566) |
| Rear tread | 195/65R15 | 63.1 (1,604) |
| | 205/55R16 | 62.8 (1,596) |
| | 225/45R17 | 62.6 (1,590) |
| | 235/40R18 | 62.2 (1,581) |
| Wheelbase | | 107 (2,720) |

Engine specification

| Item | Smartstream G 2.0 Atkinson | Smartstream G1.6 T-GDi |
|------------------------------|----------------------------|---------------------------|
| Displacement cu. in. (cc) | 121.99 (1,999) | 97.52 (1,598) |
| Bore x Stroke in. (mm) | 3.19 X 3.81 (81.0 X 97.0) | 2.98 X 3.50 (75.6 X 89.0) |
| Firing order | 1-3-4-2 | 1-3-4-2 |
| No. of cylinders | 4, in-line | 4, in-line |

Bulb wattage

| Light bulb | | | Bulb type | Wattage | |
|------------|--------------------------------------|---|-----------|---------|-----|
| Front | Type A | Headlight | High | HB3 | 60 |
| | | | Low | HB3 | 60 |
| | | Daytime Running Light (DRL)/Parking light | | LED | LED |
| | Type B | Headlight | High | LED | LED |
| | | | Low | | |
| | | Daytime Running Light (DRL)/Parking light | | LED | LED |
| | Side marker | | Bulb type | W5W | 5 |
| | | | LED type | LED | LED |
| | Turn signal light | | | PY21W | 21 |
| | Side repeater light (Outside mirror) | | | LED | LED |
| Rear | Type A | Stop light | | P21W/5W | 21 |
| | | Tail light | Inner | W5W | 5 |
| | | | Outer | P21/5W | 5 |
| | Type B | Stop light | | P21W/5W | 21 |
| | | Tail light | | LED | LED |
| | Type C | Stop light | | LED | LED |
| | | Tail light | | LED | LED |
| | Side marker | | Bulb type | W5W | 5 |
| | | | LED type | LED | LED |
| | Turn signal light | | | PY21W | 21 |
| | License plate light | | | W5W | 5 |
| | Reverse light | | | W16W | 16 |
| | High mounted stop light | | | P21W | 21 |

| | Light bulb | Bulb type | Wattage |
|----------|--------------------|-----------|---------|
| Interior | Map lamp | W10W | 10 |
| | Room lamp | FESTOON | 8 |
| | Vanity mirror lamp | FESTOON | 5 |
| | Trunk room lamp | FESTOON | 5 |
| | Mood lamp | LED | LED |

Tires and Wheels

| Item | Tire Size | Wheel Size | Inflation pressure psi (kPa) | | Wheel lug nut torque lb-ft (kgf-m, N-m) |
|--------------------|-------------|------------|------------------------------|----------|--|
| | | | Front | Rear | |
| Full size tire | 195/65 R15 | 6.0Jx15 | 34 (235) | 31 (215) | 79-94 (11-13, 107-127) |
| | 205/55 R16 | 6.5Jx16 | 34 (235) | 31 (215) | |
| | 225/45 R17 | 7.0Jx17 | 34 (235) | 31 (215) | |
| | 235/40 R18 | 8.0JX18 | 33 (230) | 33 (230) | |
| Compact spare tire | T125/80 D15 | 4Tx15 | 60 (420) | 60 (420) | |
| | T125/80 D16 | 4TX16 | 60 (420) | 60 (420) | |

NOTICE

- It is permissible to add 3 psi to the standard tire pressure specification if colder temperatures are expected soon.
Tires typically lose 1 psi (7 kPa) for every 12 °F temperature drop. If extreme temperature variations are expected, recheck your tire pressure as necessary to keep them properly inflated.
- Tire inflation pressures may vary depending on changes in elevation. If driving in areas of higher or lower elevation, be sure to check and adjust for proper tire inflation.
- Do not exceed the maximum inflation pressure, as found on the sidewall of the tire(s).

CAUTION

When replacing tires, ALWAYS use the same size, type, brand, construction, and tread pattern supplied with the vehicle. If not, it can damage the related parts or make it work irregularly.

Air conditioning system

| Item | Weight of Volume | Classification |
|---------------------------------|----------------------|----------------|
| Refrigerant oz. (g) | 17.6±0.88 (500±25) | R-1234yf |
| Compressor lubricant oz. (g) | 3.4 ± 0.3 (100 ± 10) | PAG (FD46XG) |

Contact an authorized HYUNDAI dealer for more information.

Volume and weight

| Items | Smartstream G2.0 Atkinson | Smartstream G1.6 T-GDi |
|-----------------------------------|------------------------------|---------------------------|
| | IVT | DCT |
| Gross vehicle weight lbs. (kg) | 3,858 (1,750) | 4,012 (1,820) |
| Luggage volume cu ft (ℓ) | 16.7 (474) | |

IVT: Intelligent variable transmission, DCT: Dual Clutch Transmission

Recommended lubricants and capacities

To help achieve proper engine and powertrain performance and durability, use only lubricants of the proper quality. The correct lubricants also help promote the engine efficiency that results in improved fuel economy.

These lubricants and fluids are recommended for use in your vehicle.

| Lubricant | | Volume | Classification |
|---|-------------------------------|---------------------------------|---|
| Engine oil *1 (drain and refill)  | Smartstream G 2.0 Atkinson | 4.54 US qt. (4.3 ℓ) | Full synthetic, API SN PLUS/SP or ILSAC GF-6 SAE: 0W-20 *2 |
| | Smartstream G1.6 T-GDi | 5.07 US qt. (4.8 ℓ) | Full synthetic, API SN PLUS/SP or ILSAC GF-6 SAE: 0W-20 *2 |
| Intelligent variable transmission fluid | | 6.87 US qt. (6.5 ℓ) | Hyundai genuine SP-CVT1 |
| Dual clutch transmission fluid | | 1.7-1.8 US qt. (1.6-1.7 ℓ) | SAE 70W, API GL-4, HK D DCTF TGO-10 PLUS (SK)SPIRAX S6 GHDE 70W DCTF PLUS (H.K.SHELL) |
| Coolant | Smartstream G 2.0 Atkinson | 7.82 US qt. (7.4 ℓ) | Mixture of antifreeze and water (Phosphate-based Ethylene glycol coolant for aluminum radiator) |
| | Smartstream G 1.6 T-GDi | 7.19 US qt. (6.8 ℓ) | |
| Brake fluid | | 0.74-0.85 US qt. (0.7-0.8 ℓ) | DOT-4 *3 |
| Fuel | | 12.4 US gal. (47 ℓ) | Refer to the "Fuel requirements" section in chapter 9. |

*1 Refer to the "Recommended SAE viscosity number" in this section.

*2 Requires <API SN PLUS (or above) Full synthetic> grade engine oil. If a lower grade engine oil (mineral oil including Semi-synthetic) is used, then the engine oil and engine oil filter must be replaced as indicated severe maintenance condition.

*3 To maintain the best braking performance and ABS/ESC performance, use genuine brake fluid that conform to specifications. (Standard: SAE J1704 DOT-4 LV, ISO4925 CLASS-6 and FMVSS 116 DOT-4)

NOTICE

Severe engine and transmission damage may result from the use of poor quality fuels and lubricants that do not meet HYUNDAI specifications. Always use high quality fuels and lubricants that meet the specifications listed in the recommended table.

Recommended SAE viscosity number

NOTICE

- Always be sure to clean the area around any filler plug, drain plug, or dipstick before checking or draining any lubricant. This is especially important in dusty or sandy areas and when the vehicle is used on unpaved roads. Cleaning the plug and dipstick areas will prevent dirt and grit from entering the engine and other mechanisms that could be damaged.
- Never add any additives to the engine oil. Engine oil additives can change the properties of engine oil and may cause serious engine failure.

Engine oil viscosity (thickness) has an effect on fuel economy and cold weather operating (engine start and engine oil flowability). Lower viscosity engine oils can provide better fuel economy and cold weather performance, however, higher viscosity engine oils are required for satisfactory lubrication in hot weather.

Using oils of any viscosity other than those recommended could result in engine damage. When choosing an oil, consider the range of temperature your vehicle will be operated in before the next oil change. Proceed to select the recommended oil viscosity from the chart.

| Temperature Range for SAE Viscosity Numbers | | | | | | | | | | |
|---|--|-------|-----|-----|----|----|----|-----|-----|----|
| Temperature | °C | -30 | -20 | -10 | 0 | 10 | 20 | 30 | 40 | 50 |
| | (°F) | -10 | 0 | 20 | 40 | 60 | 80 | 100 | 120 | |
| Engine Oil | Smartstream G2.0 Atkinson/ Smartstream G1.6 T-GDi | 0W-20 | | | | | | | | |



An engine oil displaying this American Petroleum Institute (API) Certification Mark conforms to the International Lubricant Specification Advisory Committee (ILSAC). It is recommended to only use engine oils that uphold this API Certification Mark.

Vehicle Identification Number (VIN)

Vin label



The VIN is also on a plate attached to the top of the left side dashboard. The number on the plate can easily be seen through the windshield from outside.

Vehicle certification label

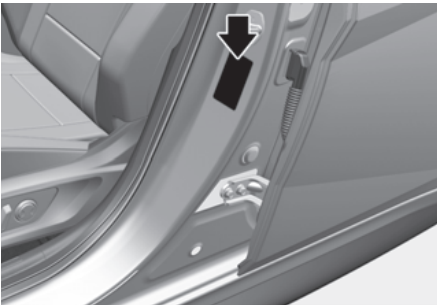

The vehicle certification label attached on the driver's side center pillar gives the vehicle identification number (VIN).

Tire specification and pressure label



The tires supplied on your new vehicle are chosen to provide the best performance for normal driving.

The tire label located on the driver's side center pillar gives the tire pressures recommended for your vehicle.

Engine number

Smartstream G2.0 Atkinson

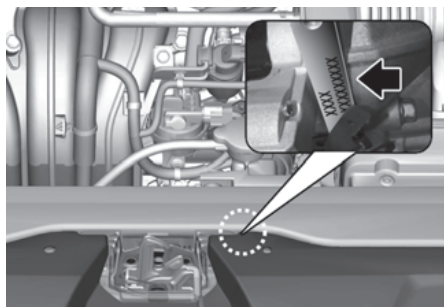

Smartstream G1.6 T-GDI

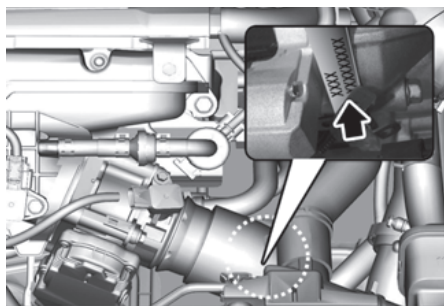

The engine number is stamped on the engine block as shown in the drawing.

Refrigerant label

if equipped



The refrigerant label provides information such as refrigerant type and amount. (R-1234yf)

Air conditioner compressor label

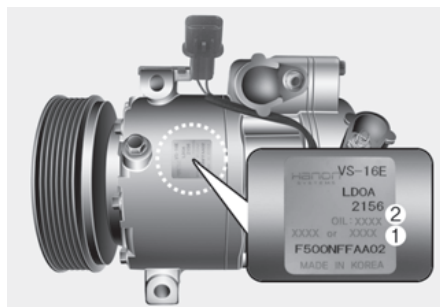

A compressor label informs you the type of compressor your vehicle is equipped with such as model, supplier part number, production number, refrigerant (1) and refrigerant oil (2).

Fuel label

 if equipped

The fuel label is attached on the fuel filler door.

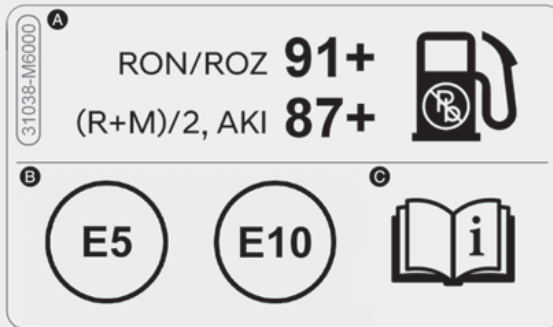

A. Octane rating of unleaded Gasoline (Petrol)

1. RON/ROZ : Research Octane Number

2. (R+M)/2, AKI : Anti Knock Index

B. Identifiers for Petrol-type fuels

* This symbol means usable fuel. Do not use any other fuel.

C. For further details, refer to "Fuel requirements" in chapter 9.

Operation in foreign countries

If you are going to drive your vehicle in another country, be sure to:

- Observe all regulations regarding registration and insurance.
- Determine that acceptable fuel is available.

Hyundai vehicle owner privacy policy

Your Hyundai vehicle may be equipped with technologies and services that use information collected, generated, recorded, or stored by the vehicle. Hyundai has created a Vehicle Owner Privacy Policy to explain how these technologies and services collect use and share this information.

You may read our Vehicle Owner Privacy Policy on the Hyundaiusa.com website at: <https://www.hyundaiusa.com/owner-privacy-policy.aspx>

If you would like to receive a hard copy of our Vehicle Owner Privacy Policy, please contact our Customer Care Center at:

Hyundai Customer Care

P.O. Box 20850

Fountain Valley, CA 92728 800-633-5151

consumeraffairs@hmmausa.com

Hyundai's Customer Care representatives are available Monday through Friday, between the hours of 6:00 AM and 5:00 PM PST and Saturday between 6:30 AM and 3:00 PM PST (English).

For Customer Care assistance in Spanish or Korean, representatives are available Monday through Friday between 6:30 AM and 3:00 PM PST.

Vehicle data collection and event data recorders

This vehicle is equipped with an event data recorder (EDR). The main purpose of an EDR is to record, in certain crash or near crash-like situations, such as an air bag deployment or hitting a road obstacle, data that will assist in understanding how a vehicle's systems performed. The EDR is designed to record data related to vehicle dynamics and safety systems for a short period of time, typically 30 seconds or less.

The EDR in this vehicle is designed to record such data as:

- How various systems in your vehicle were operating;
- Whether or not the driver and passenger safety belts were buckled/fastened;
- How far (if at all) the driver was depressing the accelerator and/or brake pedal; and,
- How fast the vehicle was traveling.

These data can help provide a better understanding of the circumstances in which crashes and injuries occur.

NOTE: EDR data are recorded by your vehicle only if a non-trivial crash situation occurs; no data are recorded by the EDR under normal driving conditions and no personal data (for example, name, gender, age, and crash location) are recorded. However, other parties, such as law enforcement, could combine the EDR data with the type of personally identifying data routinely acquired during a crash investigation.

To read data recorded by an EDR, special equipment is required, and access to the vehicle or the EDR is needed. In addition to the vehicle manufacturer, other parties, such as law enforcement, that have the special equipment, can read the information if they have access to the vehicle or the EDR.

Reporting safety defects

If you believe that your vehicle has a defect which could cause a crash or could cause injury or death, you should immediately inform the National Highway Traffic Safety Administration (NHTSA) in addition to notifying HYUNDAI MOTOR AMERICA.

To contact NHTSA, you may call the Vehicle Safety Hotline toll-free at 1-888-327-4236 (TTY: 1-800-424-9153);

go to <http://www.safercar.gov>;

download the SaferCar mobile application;

or write to: Administrator, NHTSA1200 New Jersey Ave, SE, West Building
Washington, D.C. 20590.

You can also obtain other information about motor vehicle safety from <http://www.safercar.gov>.

If NHTSA receives similar complaints, it may open an investigation, and if it finds that a safety defect exists in a group of vehicles, it may order a recall and remedy campaign. However, NHTSA cannot become involved in individual problems between you, your dealer, or HYUNDAI MOTOR AMERICA.

FCC statement

The following regulatory statement applies to all Radio Frequency (RF) devices equipped in this vehicle:

This device complies with Part 15 of the FCC Rules and with Innovation, Science and Economic Development Canada license-exempt RSS standard(s).

Operation is subject to the following two conditions:

1. This device may not cause harmful interference, and
2. This device must accept any interference received, including interference that may cause undesired operation.

Le present appareil est conforme aux CNR d` Innovation, Science and Economic Development applicables aux appareils radio exempts de licence. L'exploitation est autorisee aux deux conditions suivantes:

1. l'appareil ne doit pas produire de brouillage, et
2. l'utilisateur de l'appareil doit accepter tout brouillage radioelectrique subi, meme si le brouillage est susceptible d'en compromettre le fonctionnement.

La operacion de este equipo esta sujeta a las siguientes dos condiciones:

1. es posible que este equipo o dispositivo no cause interferencia perjudicial y
2. este equipo o dispositivo debe aceptar cualquier interferencia, incluyendo la que pueda causar su operacion no deseada.

i Information

Changes or modifications not expressly approved by the party responsible for compliance could void the user's authority to operate the equipment.

Consumer information

This consumer information has been prepared in accordance with regulations issued by the National Highway Traffic Safety Administration of the U.S. Department of Transportation. Your HYUNDAI dealer will help answer any questions you may have as you read this information.

HYUNDAI motor vehicles are designed and manufactured to meet or exceed all applicable safety standards.

For your safety, however, we strongly urge you to read and follow all directions in this Owner's Manual, particularly the information under the headings "**NOTICE**", "**CAUTION**", and "**WARNING**".

If, after reading this manual, you have any questions regarding the operation of your vehicle, please contact the Hyundai Customer Care Center:

Hyundai Customer Care

P.O. Box 20850

Fountain Valley, CA 92728

800-633-5151

consumeraffairs@hmausa.com

Hyundai's Customer Care Center representatives are available Monday through Friday, between the hours of 6:00 AM and 5:00 PM PST and Saturday between 6:30 AM and 3:00 PM PST (English).

For Customer Care assistance in Spanish or Korean, representatives are available Monday through Friday between 6:30 AM and 3:00 PM PST.

Open source software notice

This vehicle contains software with open source licenses.

Open source software information including the source code, copyright notices and referred license terms may be obtained on the website.

<https://www.hyundai.com/worldwide/opensource>

HYUNDAI Motor Company will provide the open source code to you in storage medium such as CD-ROM for minimum charge covering the cost of performing source distribution upon email request to opensource@hyundai.com within a period of 3 years from the date of product purchase.

Index

A

Accessing your vehicle 5-4
 Immobilizer system 5-14
 Remote key 5-4
 Smart key 5-7
Air cleaner 9-25
 Filter replacement 9-25
Air conditioner compressor label 10-11
Air conditioning system 10-7
Appearance care 9-62
 Exterior care 9-62
 Interior care 9-66
Automatic climate control system 5-77
 Automatic heating and air conditioning 5-78
 Manual heating and air conditioning 5-79
 System maintenance 5-86
 System operation 5-85

B

Battery 9-29
 Battery capacity label 9-31
 Battery recharging 9-31
 For longer battery life 9-30
 Reset items 9-32
Before driving 6-4
 Before entering the vehicle 6-4
 Before starting 6-4
 Vehicle break-in process 6-5
Before using driver assistance system 7-4
 Driver assistance system settings 7-5
Blind-spot Collision-Avoidance Assist (BCA) 7-37
 Blind-spot Collision-Avoidance Assist malfunction and limitations 7-41
 Blind-spot Collision-Avoidance Assist operation 7-39
 Blind-spot Collision-Avoidance Assist settings 7-38
Blind-spot View Monitor (BVM) 7-62
 Blind-spot View Monitor malfunction 7-63
 Blind-spot View Monitor operation 7-62
 Blind-spot View Monitor settings 7-62
Brake fluid 9-23
 Checking the brake fluid level 9-23
Braking system 6-28
 Anti-lock Brake System (ABS) 6-36
 Auto Hold 6-34
 Disc brakes wear indicator 6-29
 Electronic Parking Brake (EPB) 6-31
 Electronic Stability Control (ESC) 6-38
 Good braking practices 6-42
 Hill-start Assist Control (HAC) 6-41
 Parking brake 6-29

| | |
|--|------|
| Power-assist brakes | 6-28 |
| Vehicle Stability Management (VSM) | 6-40 |
| Bulb wattage | 10-4 |

C

| | |
|--|-------|
| Cabin air filter | 9-27 |
| Filter inspection | 9-27 |
| Filter replacement | 9-27 |
| California perchlorate notice | 9-73 |
| Center console overview | 2-5 |
| Child Restraint System (CRS) | 3-27 |
| Children always in the rear | 3-27 |
| Installing a Child Restraint System | 3-30 |
| Selecting a Child Restraint System | 3-28 |
| Climate control additional features | 5-92 |
| Automatic controls for the driver based on climate control system settings | 5-93 |
| Automatic ventilation | 5-92 |
| Sunroof inside air recirculation | 5-92 |
| Cluster display (Type A) | 4-23 |
| Cluster display control | 4-23 |
| Cluster display modes | 4-24 |
| Trip computer | 4-35 |
| User settings mode | 4-27 |
| Cluster display (Type B) | 4-37 |
| Cluster display control | 4-37 |
| View modes | 4-38 |
| Consumer information | 10-18 |
| Convenience Features | 5-1 |
| Cruise Control (CC) | 7-63 |
| Cruise Control operation | 7-63 |

D

| | |
|--|-------|
| Declaration of conformity | 7-123 |
| Front radar | 7-123 |
| Rear corner radar | 7-124 |
| Dimensions | 10-2 |
| Door locks | 5-25 |
| Auto door lock/unlock features | 5-28 |
| Child-protector rear door locks | 5-28 |
| Operating door locks from outside the vehicle | 5-25 |
| Operating door unlocks from inside the vehicle | 5-26 |
| Drive mode integrated control system | 6-49 |
| NORMAL, SPORT, SMART mode features | 6-50 |
| Selecting drive mode | 6-49 |
| Smart shift on trip computer | 6-51 |
| Driver Assistance System | 7-1 |
| Driver assistance system sensors | 7-120 |
| Cameras | 7-120 |
| Radars | 7-121 |

Ultrasonic sensors 7-122

Driver Attention Warning (DAW) 7-56

Driver Attention Warning malfunction and limitations 7-59

Driver Attention Warning operation 7-57

Driver Attention Warning settings 7-56

Driving Your Vehicle 6-1

Dual Clutch Transmission 6-20

Dual Clutch Transmission operation 6-21

Good driving practices 6-27

Paddle shifter (Manual shift mode) 6-27

Parking 6-26

Dual clutch Transmission

DCT warning messages 6-25

E

Emergency Situations 8-1

Emission control system 9-69

Crankcase emission control system 9-69

Evaporative emission control system including onboard refueling vapor recovery (ORVR) 9-70

Exhaust emission control system 9-70

Engine Compartment 9-4

Engine compartment overview 2-6

Engine coolant 9-21

Changing coolant 9-23

Checking the coolant level 9-21

Engine number 10-11

Engine oil 9-19

Checking the engine oil and filter 9-20

Checking the engine oil level 9-19

Engine specification 10-3

Explanation of scheduled maintenance items 9-17

Air cleaner filter 9-17

Air conditioning refrigerant 9-18

Brake discs, pads, calipers, and rotors 9-18

Brake fluid 9-18

Brake hoses and lines 9-18

Cooling system 9-17

Drive belts 9-17

Drive shaft and related 9-18

Dual Clutch Transmission fluid 9-18

Engine coolant 9-18

Engine oil and filter 9-17

Fuel filter 9-17

Fuel lines, fuel hoses and connections 9-17

Intelligent Variable Transmission fluid 9-18

Parking brake 9-18

Spark plugs 9-17

Steering gear box, linkage & boots/lower arm ball joint 9-18

Suspension mounting bolts 9-18

Vacuum crankcase ventilation hoses 9-17

| | |
|---|------|
| Vapor hose and fuel filler cap | 9-17 |
| Exterior lights | 5-56 |
| High beam operation | 5-57 |
| Lighting control | 5-56 |
| Turn signals and lane change signals | 5-58 |
| Exterior overview (Front view) | 2-2 |
| Exterior overview (Rear view) | 2-3 |

F

| | |
|--|-------|
| Forward Collision Avoidance Assist (FCA) (Front view camera only) | 7-6 |
| Forward Collision Avoidance Assist malfunction and limitations | 7-9 |
| Forward Collision Avoidance Assist operation | 7-7 |
| Forward Collision Avoidance Assist settings | 7-6 |
| Forward Collision Avoidance Assist (FCA) (Sensor fusion) | 7-17 |
| Forward Collision Avoidance Assist malfunction and limitations | 7-24 |
| Forward Collision Avoidance Assist operation | 7-19 |
| Forward Collision Avoidance Assist settings | 7-18 |
| Forward/Reverse Parking Distance Warning (PDW) | 7-110 |
| Forward/Reverse Parking Distance Warning malfunction and limitations | 7-110 |
| Forward/Reverse Parking Distance Warning malfunction and precautions | 7-112 |
| Fuel filler door | 5-54 |
| Closing the fuel filler door | 5-54 |
| Opening the fuel filler door | 5-54 |
| Fuel label | 10-12 |
| Fuel requirements | 9-71 |
| Gasoline engine | 9-71 |
| Fuses | 9-45 |
| Engine compartment panel fuse replacement | 9-46 |
| Fuse/Relay panel description | 9-48 |
| Instrument panel fuse replacement | 9-46 |

H

| | |
|--|------|
| Hazard warning flasher | 8-2 |
| High Beam Assist (HBA) | 5-62 |
| High Beam Assist malfunction and limitations | 5-63 |
| High Beam Assist operation | 5-63 |
| High Beam Assist settings | 5-62 |
| Highway Driving Assist (HDA) | 7-90 |
| Highway Driving Assist malfunction and limitations | 7-93 |
| Highway Driving Assist operation | 7-91 |
| Highway Driving Assist settings | 7-90 |
| Hood | 5-48 |
| Closing the hood | 5-48 |
| Opening the hood | 5-48 |
| Hyundai digital key | 5-14 |
| Digital key (Card key) | 5-19 |
| Digital key (smartphone) | 5-14 |
| Limitations of the system | 5-24 |
| Used vehicle/digital key maintenance | 5-24 |

HYUNDAI Motor America 1-3
Hyundai vehicle owner privacy policy 10-14

I

Idle Stop and Go (ISG) system 6-42
 Auto start 6-43
 Auto stop 6-42
 Deactivating the ISG 6-44
 ISG malfunction 6-45
 Operating conditions 6-44
 Smart ISG features 6-45
If the engine does not start 8-3
If the engine overheats 8-6
If you have a flat tire 8-13
 Changing tires 8-15
 Jack and tools 8-13
 Jack label 8-14
Important safety precautions 3-3
 Airbag hazards 3-3
 Always wear your seat belt 3-3
 Control your speed 3-4
 Driver distraction 3-3
 Keep your vehicle in proper operating condition - Inspecting your tires 3-4
 Never drink or take drugs and drive. 3-4
 Restrain all children 3-3
In case of an emergency while driving 8-2
 If the engine stalls at a crossroad or crossing 8-2
 If the engine stalls while driving 8-2
 If you have a flat tire while driving 8-3
Index 11-1
Infotainment system 5-100
 Antenna 5-100
 Bluetooth® wireless technology 5-102
 How vehicle radio works 5-103
 Infotainment system 5-102
 Steering wheel audio control 5-101
 USB port 5-100
 Voice recognition 5-102
Instrument Cluster 4-1
Instrument cluster 4-2
 Cluster display messages 4-19
 Gauges and meters 4-3
 Instrument cluster control 4-3
 Transmission shift indicator 4-8
 Warning and indicator lights 4-8
Intelligent Speed Limit Assist (ISLA) 7-51
 Intelligent Speed Limit Assist malfunction and limitations 7-54
 Intelligent Speed Limit Assist operation 7-52
 Intelligent Speed Limit Assist settings 7-52
Intelligent Variable Transmission 6-14

| | |
|---|----------|
| Good driving practices | 6-18 |
| Intelligent Variable Transmission operation | 6-15 |
| Parking | 6-18 |
| Interior features | 5-94 |
| Clock | 5-99 |
| Coat hook | 5-99 |
| Cup holder | 5-94 |
| Power outlet | 5-95 |
| Sunvisor | 5-95 |
| USB charger | 5-96 |
| Wireless smartphone charging system | 5-97 |
| Interior lights | 5-59 |
| Interior lights auto off | 5-59 |
| Luggage compartment lamp | 5-61 |
| Mood lamp | 5-60 |
| Rear room lamp | 5-60 |
| Vanity mirror lamp | 5-60 |
| Interior overview | 2-4 |
| Introduction | 1-1, 1-2 |

J

| | |
|----------------------------|-----|
| Jump starting | 8-4 |
|----------------------------|-----|

K

| | |
|-------------------------------------|-----|
| Key ignition switch | 6-5 |
| Key ignition switch positions | 6-7 |
| Starting the engine | 6-8 |
| Turning off the engine | 6-8 |

L

| | |
|--|------|
| Lane Following Assist (LFA) | 7-87 |
| Lane Following Assist operation | 7-87 |
| Lane following assist (LFA) | |
| Lane Following Assist malfunction and limitations | 7-89 |
| Lane Keeping Assist (LKA) | 7-32 |
| Lane Keeping Assist malfunction and limitations | 7-35 |
| Lane Keeping Assist operation | 7-33 |
| Lane Keeping Assist settings | 7-32 |
| Light bulbs | 9-55 |
| Headlight, parking light, Daytime Running Light, turn signal light, side marker replacement .. | 9-56 |
| High mounted stop light replacement | 9-60 |
| Interior light replacement | 9-61 |
| License plate light bulb replacement | 9-60 |
| Rear combination light replacement | 9-57 |
| Side repeater light replacement | 9-57 |

M

| | |
|--------------------------|-----|
| Maintenance | 9-1 |
|--------------------------|-----|

| | |
|---|------|
| Maintenance services | 9-5 |
| Guide to hyundai genuine parts | 9-5 |
| Owner maintenance precautions | 9-6 |
| Owner's responsibility | 9-6 |
| Manual climate control system | 5-67 |
| Heating and air conditioning | 5-68 |
| System maintenance | 5-75 |
| System operation | 5-73 |
| Manual Speed Limit Assist (MSLA) | 7-49 |
| Manual Speed Limit Assist operation | 7-49 |
| Mirrors | 5-32 |
| Inside rearview mirror | 5-32 |
| Side view mirrors | 5-38 |

N

| | |
|--|------|
| Navigation-based Smart Cruise Control (NSCC) | 7-82 |
| Limitations of Navigation-based Smart Cruise Control | 7-84 |
| Navigation-based Smart Cruise Control operation | 7-83 |
| Navigation-based Smart Cruise Control settings | 7-82 |

O

| | |
|---|-------|
| Open source software notice | 10-19 |
| Operation in foreign countries | 10-13 |
| Owner maintenance | 9-7 |
| Owner maintenance schedule | 9-7 |

P

| | |
|---|------|
| Parking brake | 9-24 |
| Checking the parking brake | 9-24 |
| Picture Index | 2-1 |
| Push button start ignition switch | 6-9 |
| Push button start ignition switch positions | 6-10 |
| Remotely starting the engine | 6-12 |
| Starting the engine | 6-11 |
| Turning off the engine | 6-12 |

R

| | |
|---|-------|
| Rear Cross-traffic Collision-Avoidance Assist (RCCA) | 7-101 |
| Rear Cross-traffic Collision-Avoidance Assist malfunction and limitations | 7-106 |
| Rear Cross-traffic Collision-Avoidance Assist operation | 7-102 |
| Rear Cross-traffic Collision-Avoidance Assist settings | 7-102 |
| Rear Occupant Alert (ROA) | 5-30 |
| Rear occupant alert operations | 5-30 |
| Rear View Monitor (RVM) | 7-94 |
| Rear View Monitor malfunction and limitations | 7-97 |
| Rear View Monitor operation | 7-95 |
| Rear View Monitor settings | 7-95 |
| Recommended lubricants and capacities | 10-8 |
| Recommended SAE viscosity number | 10-9 |

| | |
|---|---------------------|
| Refrigerant label | 10-11 |
| Reporting safety defects | 10-16 |
| FCC statement | 10-17 |
| Reverse Parking Collision-Avoidance Assist (PCA) | 7-114 |
| Reverse Parking Collision-Avoidance Assist settings | 7-114, 7-115, 7-116 |

S

| | |
|--|------|
| Safe Exit Warning (SEW) | 7-45 |
| Safe Exit Warning malfunction and limitations | 7-47 |
| Safe Exit Warning operation | 7-46 |
| Safe Exit Warning settings | 7-45 |
| Safety messages | 1-4 |
| Scheduled maintenance services | 9-9 |
| Maintenance under severe usage conditions | 9-15 |
| Normal maintenance schedule | 9-11 |
| Seat belts | 3-18 |
| Additional seat belt safety precautions | 3-25 |
| Care of seat belts | 3-27 |
| Seat belt restraint system | 3-20 |
| Seat belt safety precautions | 3-18 |
| Seat belt warning light | 3-19 |
| Seats | 3-5 |
| Front seats | 3-7 |
| Head restraints | 3-13 |
| Rear seats | 3-11 |
| Safety precautions | 3-6 |
| Seat warmers | 3-17 |
| Seats & Safety System | 3-1 |
| Smart Cruise Control (SCC) | 7-67 |
| Smart Cruise Control malfunction and limitations | 7-76 |
| Smart Cruise Control operation | 7-68 |
| Smart Cruise Control settings | 7-67 |
| Special driving conditions | 6-51 |
| Driving at night | 6-52 |
| Driving in flooded areas | 6-53 |
| Driving in the rain | 6-52 |
| Hazardous driving conditions | 6-51 |
| Highway driving | 6-53 |
| Rocking the vehicle | 6-51 |
| Smooth cornering | 6-52 |
| Steering wheel | 5-30 |
| horn | 5-31 |
| Motor Driven Power Steering (MDPS) | 5-30 |
| Tilt/telescopic steering | 5-31 |
| Storage compartment | 5-93 |
| Center console storage | 5-94 |
| Glove box | 5-94 |
| Sunroof | 5-44 |
| Automatic reversal | 5-46 |
| Resetting the sunroof | 5-47 |

| | |
|---|-------|
| Slide open/close | 5-45 |
| Sunroof open warning | 5-47 |
| Sunshade | 5-44 |
| Tilt open/close | 5-45 |
| Supplemental restraint system - airbags | 3-36 |
| Additional safety precautions | 3-56 |
| Airbag warning labels | 3-56 |
| How does the airbag system operate? | 3-42 |
| Occupant Classification System (OCS) | 3-46 |
| SRS care | 3-55 |
| SRS components | 3-38 |
| SRS warning light | 3-45 |
| What to expect after an airbag inflates | 3-44 |
| Where are the airbags? | 3-39 |
| Why didn't my airbag go off in a collision? | 3-51 |
| Surround View Monitor (SVM) | 7-97 |
| Surround View Monitor malfunction and limitations | 7-101 |
| Surround View Monitor operation | 7-99 |
| Surround view monitor (SVM) | |
| Surround View Monitor settings | 7-98 |

T

| | |
|---|-------|
| Theft-alarm system | 5-29 |
| Tire Pressure Monitoring System (TPMS) | 8-8 |
| Changing a tire with TPMS | 8-11 |
| Check tire pressure | 8-8 |
| Low tire pressure position and tire pressure telltale | 8-10 |
| Low tire pressure warning light | 8-10 |
| Tire pressure monitoring system | 8-9 |
| TPMS malfunction indicator | 8-11 |
| Tire specification and pressure label | 10-10 |
| Tires and Wheels | 10-6 |
| Tires and wheels | 9-33 |
| All season tires | 9-43 |
| Check tire inflation pressure | 9-34 |
| Low aspect ratio tires | 9-44 |
| Radial-ply tires | 9-44 |
| Recommended cold tire inflation pressures | 9-33 |
| Snow tires | 9-43 |
| Summer tires | 9-43 |
| Tire care | 9-33 |
| Tire maintenance | 9-37 |
| Tire replacement | 9-36 |
| Tire rotation | 9-35 |
| Tire sidewall labeling | 9-37 |
| Tire terminology and definitions | 9-40 |
| Tire traction | 9-37 |
| Wheel alignment and tire balance | 9-35 |
| Wheel replacement | 9-37 |
| Towing | 8-18 |

| | |
|--------------------------------------|------|
| Emergency towing | 8-20 |
| Removable towing hook | 8-19 |
| Towing service | 8-18 |
| Trailer towing | 6-57 |
| Trunk | 5-49 |
| Emergency trunk safety release | 5-50 |
| Smart Trunk release | 5-51 |

V

| | |
|--|-------|
| Vehicle Auto-Shut Off | 6-13 |
| Deactivating conditions | 6-13 |
| Operating conditions | 6-13 |
| System operation | 6-13 |
| Vehicle certification label | 10-10 |
| Vehicle data collection and event data recorders | 10-15 |
| Vehicle Identification Number (VIN) | 10-10 |
| Vehicle Information, Reporting Safety Defects, and Consumer Information | 10-1 |
| Vehicle load limit | 6-57 |
| The loading information label | 6-58 |
| Vehicle modifications | 1-5 |
| Vehicle settings (infotainment system) | 4-41 |
| Setting your vehicle | 4-41 |
| Volume and weight | 10-7 |

W

| | |
|---|------|
| Washer fluid | 9-25 |
| Checking the washer fluid level | 9-25 |
| Welcome system | 5-61 |
| Door handle light | 5-61 |
| Headlight and parking light | 5-62 |
| Interior light | 5-62 |
| Windows | 5-40 |
| Power windows | 5-41 |
| Windshield defrosting and defogging | 5-88 |
| Auto defogging system (only for automatic climate control system) | 5-91 |
| Automatic climate control system | 5-89 |
| Defogging logic | 5-90 |
| Manual climate control system | 5-88 |
| Rear window defroster | 5-91 |
| Winter driving | 6-54 |
| Snow or icy conditions | 6-54 |
| Winter precautions | 6-55 |
| Wiper blades | 9-28 |
| Blade inspection | 9-28 |
| Blade replacement | 9-28 |
| Wipers and washers | 5-65 |
| Front windshield washers | 5-66 |
| Windshield wipers | 5-65 |